

# MADERA

SEATING + TABLE SOLUTIONS

Indiana  
FURNITURE



## SOPHISTICATED STATURE.

Madera offers the prestige of finely crafted Walnut, Cherry, Maple, and Oak veneers, while an ultra-violet topcoat on exposed surfaces adds extreme durability.

Modular components and an abundance of options for finishes, edges, and pulls create diverse looks, from luxe transitional to refined contemporary. Multiple desk front and top options help to articulate a look while generous storage options easily outfit private offices to open areas.

The premium veneer option on Madera offers a grade of veneer exceeding the general commercial market standards and meets/exceeds the specifications required for government entities, such as the U.S. Army Corps of Engineers.

Madera is responsible too. It considers the environment by using renewable and recyclable materials, allowing it to achieve indoor air quality and BIFMA level® certifications, and complies with the mechanical standards that focus on safety and durability to meet BIFMA Compliant® certification.



## Versatile Presence.

Integrate a mix of materials from modular components such as peninsula desks and metal legs to achieve a lighter scale or articulate a sense of space in smaller environments. Or add a stepped front desk to an L configuration to extend the work space and create more comfortable leg room for one-on-one meetings.

Madera also integrates harmoniously with Aura Reception configurations. Carry the design into board rooms with all the same options available in Aura Conference.



Two desk front options help articulate a style. Specify a recessed front for a lighter appearance or a stepped front for layered interest.

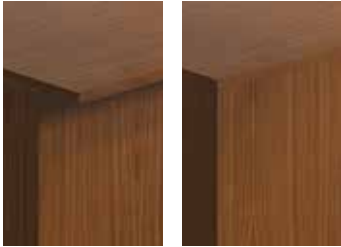

Top options to help compose or define a look. Emphasize clean space with an overhang or underscore solidity with a flush top. Also available with a bow top.



Bridges, returns, and credenzas available with full or half modesty panels.



Add design and function to your workspace with a tackboard, in your choice of upholsteries to work with surface mount and wall mount hutches.



Add storage to your surface mount hutches with optional paper slots; factory installed for your convenience.



Pedestals available in two versions. The full pedestal offers box/box/file or file/file configurations, while the 3/4 ped option, with a box/file, floats above the floor.



Tops feature vertical profiles except with the Radius (A) and Bevel (B) edge profiles, which provide a matching reverse shape on the adjoining unit.



Complete your private office or outfit a nearby meeting space with Madera Tables. Offered in veneer and laminate tops and bases, as well as metal base options.



A Premium Veneer option is available and meets/exceeds the technical specifications required by the U.S. Army Corps of Engineers, among others.



## Statement of Line:

### Standard Components

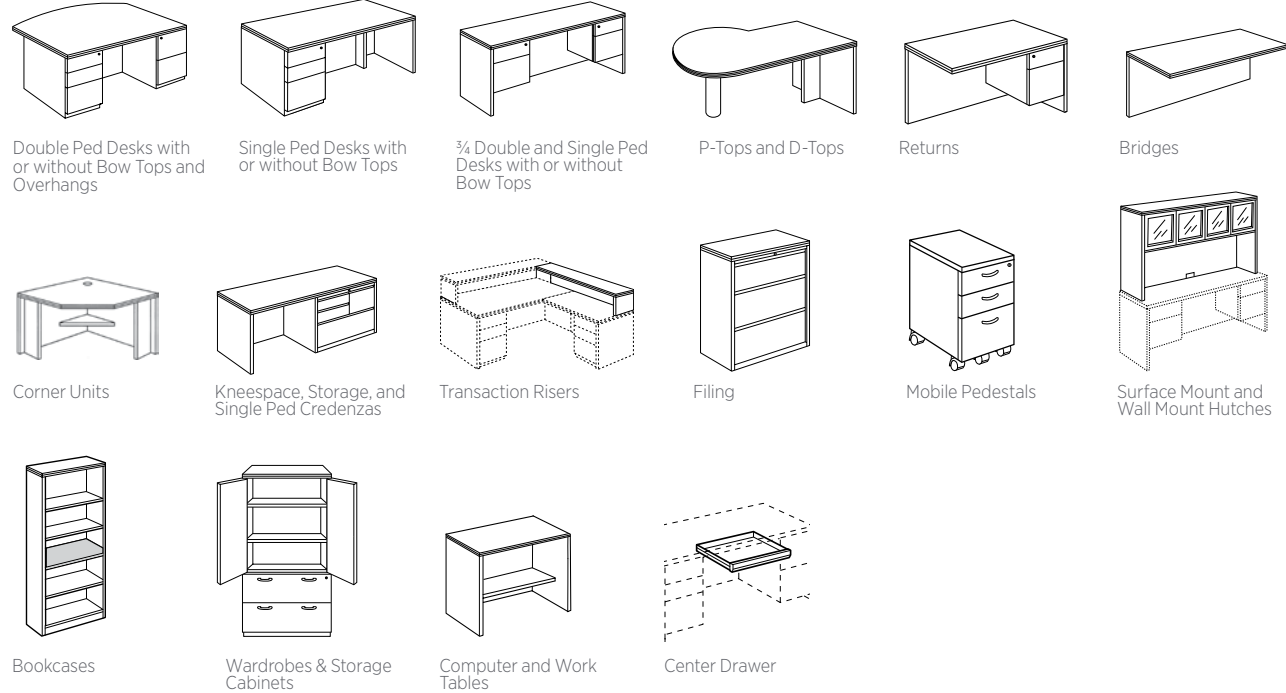

### Modular Components

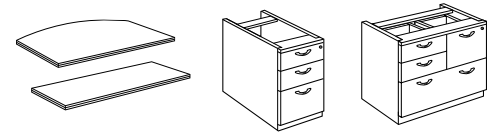

### Tables + Bases

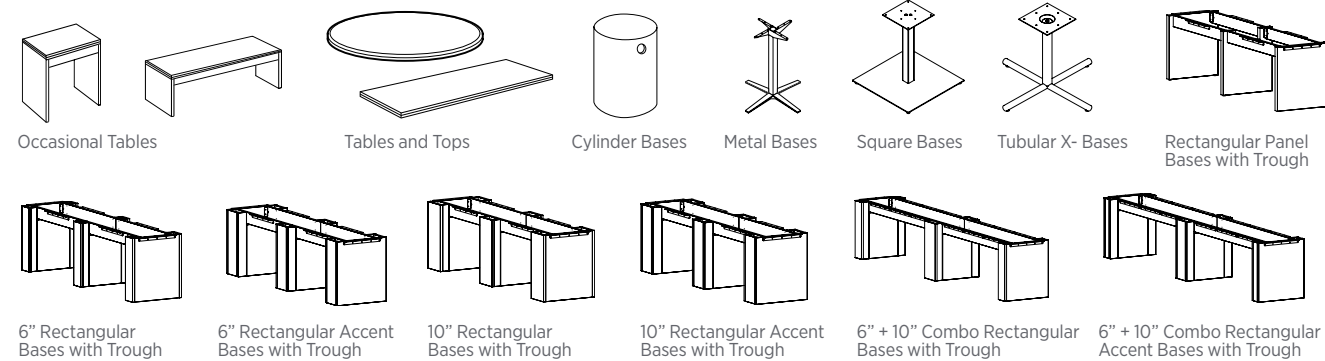

### Keyboard, Tackboard, Tasklights, and Other Accessories

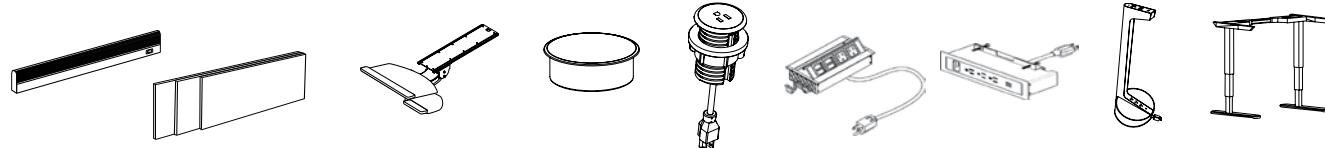

## Surface Materials:

### Veneer and Laminate Options

Madera models come standard with a Veneer chassis and a Veneer or HPL worksurface. Our Veneer options feature our UV topcoat finish, UVAdvantage. The result is a low-emitting finish that provides exceptional depth, clarity, durability, and chemical resistance throughout the life of the product.

A premium Veneer option is also available, which exceeds the general commercial market standards as determined by the Architectural Woodworking Institute's (AWI) quality certification standards.

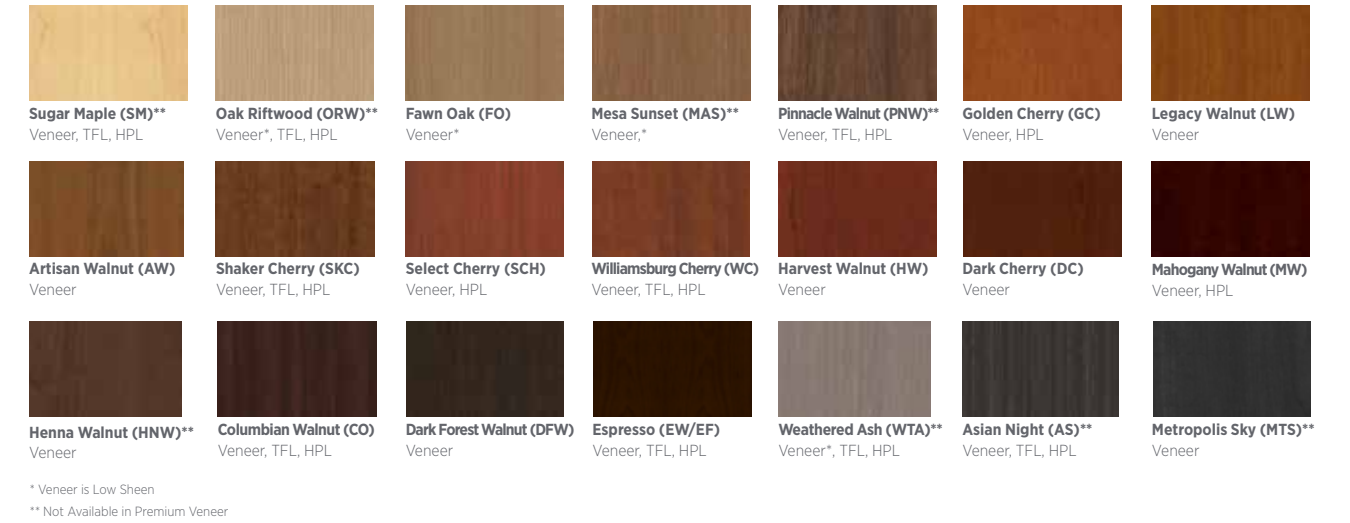

### Pull Options:

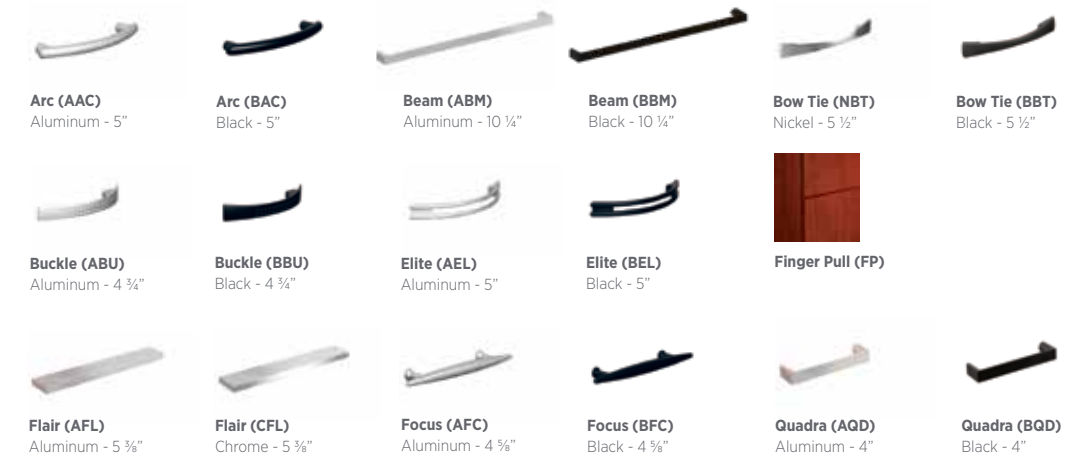

### Edge Profiles:



Colors represented are high-resolution reproductions and may vary slightly from the actual product. To order samples, please contact our Customer Service team or order online at [www.indianafurniture.com](http://www.indianafurniture.com). Graining and finish colors may vary, yet will continue to complement, across Veneer, HPL, TFL, and Seating products due to the inherent differences of these materials.



# Indiana FURNITURE

1919 Hospitality Dr., Ste. A  
PO Box 270  
Jasper, Indiana 47547-0270

Tel 812.482.5727  
Tol 800.422.5727  
Fax 812.482.9035  
sales@indianafurniture.com  
www.indianafurniture.com

