



# TABLES + SPACE DIVISION

PRICING EFFECTIVE AUGUST 1, 2022

Indiana  
FURNITURE

Being over a century old hasn't slowed us down! Sure, we are still the reliable, ethical company that was born in southern Indiana, steeped in quality, craftsmanship, and service. But have you seen our latest introductions? We are making a splash with design and challenging the concept of modern offices. Go ahead. Take a look. You know you want to.

## Our Pledge to People + Our Planet.

We've been making wood furniture longer than just about anyone...and we want to be doing so for a long time to come. That's a large part of why we take a stewardship approach to our resources. We believe that environmental sustainability and business profits need not be mutually exclusive. They can and should exist side by side in a mutually beneficial relationship. And for more than a century, we've been showing how it's done.

We've proven our commitment to a sustainable future by supporting the standards and programs that protect our home planet and human health. Whether it's local sourcing, reducing contaminants, implementing wellness and safety programs, or diverting waste from landfills, social responsibility is a part of every decision we make at Indiana Furniture.

One of the surest ways to reduce our impact on the planet is to make and buy things that last. And this one's a natural for us. Our products are made with craftsmanship and attention to detail that are a part of our more than a century-long legacy in wood manufacturing. And our products are backed by our 12-year warranty, which facilitates maintenance, servicing and reassembly.

All of our product lines:

- Are manufactured and assembled in the USA,
- Meet or exceed Indoor Air quality standards\*,
- Meet or exceed BIFMA level® Sustainability standards and certification\*,
- Conform to the BIFMA Compliance standards\*,
- Comply with TSCA Title VI (CARB) standards,
- and can contribute to U.S. Green Building's LEED Program.

To learn more, simply go to [www.IndianaFurniture.com/resources](http://www.IndianaFurniture.com/resources).



## Ease of Specification

Whether you're looking to specify your office spaces or simply to visualize them in the options and surface materials you are desiring, we make it easy. You can find the entire Indiana Furniture portfolio on the following third-party, space-planning platforms.



\* Recently launched or new products may still be in testing; Cush Pillows is currently not BIFMA Compliant due to no available compliance test.

|   |                   |
|---|-------------------|
| <b><u>General Information + Conditions of Sale</u></b>            | <b><u>2</u></b>   |
| <b><u>Warranty</u></b>  | <b><u>3</u></b>   |
| <b><u>Tables+Storage</u></b>                                      | <b><u>5</u></b>   |
| <u>Allegiance (1100 Series)</u>                                   | <u>7</u>          |
| <u>Arlington (2900 Series)</u>                                    | <u>13</u>         |
| <u>Aura (9200 Series)</u>   | <u>25</u>         |
| <u>Cameo (9100 Series)</u>  | <u>45</u>         |
| <u>Canvas (9400 Series)</u>                                       | <u>61</u>         |
| <u>Gesso (9700 Series)</u>  | <u>83</u>         |
| <u>Iconic (5000 Series)</u>                                       | <u>105</u>        |
| <u>Jefferson (4600 Series)</u>                                    | <u>123</u>        |
| <u>Madera (1400/1600 Series)</u>                                  | <u>129</u>        |
| <u>Natta by Edge Design (NAT Series)</u>                          | <u>137</u>        |
| <u>One10 (9600 Series)</u>  | <u>139</u>        |
| <u>Phoenix (2100 Series)</u>                                      | <u>187</u>        |
| <u>Tri-One (8500/8600 Series)</u>                                 | <u>193</u>        |
| <u>Grommets/Power/Data for Aura, Cameo, Canvas + Gesso</u>        | <u>221</u>        |
| <br>  |                   |
| <b><u>Occasional Tables</u></b>                                   | <b><u>235</u></b> |
| General Occasional Tables Information                             | <u>236</u>        |
| <u>Arlington End, Lamp + Magazine Tables (2900 Series)</u>        | <u>237</u>        |
| <u>Bailey End + Cocktail Tables (720 Series)</u>                  | <u>239</u>        |
| <u>Britta End + Cocktail (230 Series)</u>                         | <u>243</u>        |
| <u>Canvas End + Magazine Tables (6600 Series)</u>                 | <u>245</u>        |
| <u>Cicero End, Lamp, Magazine + Console Tables (290 Series)</u>   | <u>247</u>        |
| <u>Gesso End + Magazine Tables (6500 Series)</u>                  | <u>249</u>        |
| <u>Inspiration Lamp + Magazine Tables (480 Series)</u>            | <u>251</u>        |
| <u>Isla End, Lamp + Magazine Tables (370 Series)</u>              | <u>253</u>        |
| <u>Jefferson End, Lamp &amp; Magazine Tables (4600 Series)</u>    | <u>255</u>        |
| <u>Jot Auxiliary, End, Cocktail + Console Tables (410 Series)</u> | <u>257</u>        |
| <u>Madera End, Lamp + Magazine Tables (1400 Series)</u>           | <u>261</u>        |
| <u>Me, Myself &amp; I Tables by Edge Design (MMI Series)</u>      | <u>263</u>        |
| <u>Phoenix End + Magazine Tables (2100 Series)</u>                | <u>265</u>        |
| <u>Plush Cocktail Tables (620 Series)</u>                         | <u>267</u>        |
| <u>Spirit Tables by Edge Design (S Series)</u>                    | <u>271</u>        |
| <u>Topsy Turvy End, Magazine + Console Tables (521 Series)</u>    | <u>273</u>        |
| <br>  |                   |
| <b><u>Space Division</u></b>                                      | <b><u>277</u></b> |
| Screens+Dividers  | <u>279</u>        |
| Square One (1700 Series)  | <u>291</u>        |

## ORDERING INFORMATION

All orders should be emailed to [neworders@indianafurniture.com](mailto:neworders@indianafurniture.com). Orders can be faxed to 812-482-9035 or mailed to:

Indiana Furniture  
P.O. Box 270  
1224 Mill Street  
Jasper, IN 47547-0270

## ORDER PROCEDURE

All orders must include purchase order number, billing address, ship-to address and phone number, and any special instructions.

When ordering casegoods or tables, give complete quantity, model number, finish and any other options.

When ordering seating, give complete quantity, model number, finish, fabric and any other options.

Within each series, an example of "How to Order" is illustrated at the beginning of each series section. For further clarification of order procedure, contact Customer Service.

## PRICING

All prices shown are suggested retail prices F.O.B. Point of Origin, freight prepaid and allowed to one continental US destination. Prices, specifications and materials are subject to change without notice. Possession and/or distribution of this price list does not in itself constitute an offer to sell. Orders can be received only from authorized Indiana Furniture dealers. Orders will be billed at prices prevailing at time of shipment, unless acknowledged prior to the effective date of the price change, in which case billing will be at the price acknowledged.

## ACKNOWLEDGMENT

All orders will be acknowledged promptly, showing how the order was entered, its approximate shipping date and other pertinent information. This acknowledgment is the final agreement between the customer and Indiana Furniture and is the exclusive statement of the terms thereof. Please examine this acknowledgment carefully and advise Indiana Furniture immediately of any discrepancies.

## BUYER'S OBLIGATION: RIGHTS OF SELLER

If Indiana Furniture shall at any time doubt Buyer's financial responsibility, Indiana Furniture may decline to make shipments hereunder except upon receipt of cash payment in advance or security or other proof of responsibility satisfactory to Indiana Furniture. If buyer fails in any way to fulfill the terms and conditions set forth herein, Indiana Furniture may defer shipments until such default is corrected. Remedies provided herein shall be in addition to, and not in lieu of other remedies. Buyer agrees to abide by payment terms as listed on invoice. Buyer shall pay all reasonable costs and expenses, including attorney and collection fees, and late fees, incurred by Seller in connection with any amounts due for goods ordered.

## CANCELLATIONS AND CHANGES

Due to immediate production on build-to-order items, all orders are considered firm and are not subject to cancellation or change without approval from Indiana Furniture. All approved changes are subject to additional charges and revised lead times.

## PRODUCT DESIGN AND SPECIFICATION CHANGES

Indiana Furniture reserves the right to make changes in design and construction or discontinue products without prior notice.

## REPAIR CHARGES

Indiana Furniture will only pay repair charges if Customer Service gives prior written authorization. No repair charge will be paid without advance approval at which time you will be issued a repair authorization number that will allow you to invoice Indiana Furniture for the completed work.

## WAREHOUSE STORAGE CHARGES

If a shipment is held beyond 14 calendar days at your request, a **.067% per calendar day** (2% per month) storage charge will be assessed. The effective date will be 14 calendar days after the acknowledged ship date. Further, the prices applied to the order will be those in effect at the time of shipment.

## DAMAGED MERCHANDISE

The consignee is responsible for filing claims with the carrier for damage and shortages. Claims for both obvious and concealed damage must be filed within 15 calendar days, and the damaged merchandise must not have been moved from the original receiving location. All damaged merchandise, including the cartons and packing materials, must be retained for inspection by either the carrier or by an Indiana Furniture Sales Representative. Indiana Furniture reserves the right to select the most cost effective way to repair or replace the damaged item. Once you have notified the carrier, please contact Customer Service for further assistance.

**Obvious Damage/Missing Cartons** — Do not refuse merchandise damaged in transit. Indiana Furniture recommends the consignee inspect all merchandise upon arrival. If a shipment is received damaged or short, note all information on carrier's copy and your copy of freight bill and delivery receipt. Notify the delivering carrier and file a claim immediately. Pending the results of your claim, either Indiana Furniture or the carrier will cover 100% of the cost to repair or replace the damaged or missing item.

**Concealed Damage** — If concealed damage is discovered, notify the delivering carrier at once and request an inspection. This must be done within 15 calendar days of delivery. If the carrier will not perform the inspection, you should prepare an affidavit that you contacted them, noting the time and date, and that they failed to comply with your request. This, along with the other papers in your possession, will support the claim. Pending the results of your claim, the cost to repair or replace the item will be covered 1/3 by the carrier and 2/3 by Indiana Furniture for shipments less than a full truckload and 100% by Indiana Furniture for shipments of full truck loads.

## RETURN MERCHANDISE

Merchandise will not be accepted for return without a RGA (Return Goods Authorization) issued by Indiana Furniture. We will consider issuing RGAs for the following reasons:

1. Manufacturing defect (inspected by Indiana Furniture representative)
2. Indiana Furniture order processing error
3. Shipping error
4. Mis-marked cartons
5. Duplicated shipments

If you have any questions as to whether your reason for return qualifies for consideration, please contact your Customer Service Representative. Merchandise must be returned within 60 days of the RGA issued date, or within 60 days upon receipt of replacement product to receive credit. Returns due to mis-marked cartons must also be returned in the original cartoning, with shipping labels intact, to receive credit.

**All merchandise being returned must be properly packed and protected to ensure no further damage is incurred during transportation back to an Indiana Furniture facility. Upon receipt, all returned merchandise will be thoroughly inspected and the results compared to the reason for return stated on the RGA. Any discrepancies, such as additional damage, signs of usage, missing parts, etc., will result in an adjustment to the amount of credit issued.**

## DELIVERY AND FREIGHT CHARGES

All shipments are F.O.B. Point of Origin, Jasper, IN, freight prepaid and allowed dock to dock on 53' trailer. Ownership and responsibility of the merchandise becomes that of the buyer upon delivery to the freight company. Shipments into Alaska, Hawaii, Canada, Mexico, Puerto Rico and other exports are freight prepaid and allowed to port of exit.

Indiana Furniture reserves the right to select the most appropriate carrier and routing on all shipments. Indiana Furniture will attempt to accommodate requests for favored carriers and delivery times. Deliveries requested Monday through Thursday, after 3pm, will be assessed a \$300 per truck after hours fee. Deliveries requested after 3pm on Friday or on weekends, will be assessed a \$600 per truck weekend delivery fee.

Inside delivery and installation services are not included in the pricing shown. Any deviation from dock-to-dock delivery, such as but not limited to, non-dock, residential, or inside delivery must be specified on the order. Should these services be requested or required, all charges incurred will be charged to the "Sold To" of the order.

Shipments totaling less than \$3000 (net value, product only) will be assessed a small order fee of \$300 net per shipment. This fee will be reduced for items shipped via small package carriers. For order shipments of \$100 or less, shipped by small package carrier, the fee is \$18. For order shipments over \$100, shipped by small package carrier, the fee is \$40.

## BIFMA AND ANSI TESTING

Indiana Furniture is a member of the Business and Institutional Furniture Manufacturer's Association (BIFMA). Tests developed by the BIFMA and approved by the American National Standards Institute (ANSI) determine the strength and durability of casegoods and seating in its everyday use. Although this testing does not serve as a warranty or guarantee, Indiana Furniture products within this price list have been tested by an independent verifying body and meet or exceed applicable BIFMA and ANSI standards.



Subject to the limitations set forth in this warranty, Indiana Furniture Industries, Inc. (“**Indiana Furniture**”) warrants to the original purchaser all product in this price list (“**Product**”) to be free from defects in material and workmanship given normal use for a 12-year period from the date of manufacture. During the applicable warranty period, Indiana Furniture, as its sole obligation, will repair or replace (in Indiana Furniture’s sole discretion) any Product, part, or component covered by this warranty and sold after August 2, 2022, which fails under normal use as a result of a defect in material or workmanship. Normal use is defined as the equivalent of a single shift, 40-hour work week. Indiana Furniture will repair or replace the defective Product, part, or component with a comparable Product, part, or component.

**Warranty periods are limited** for certain Products and parts as follows:

**12-year Warranty** (from the date of manufacture)

- Seating Mechanisms
- Veneers
- Laminates
- Casters and Glides

**7-year Warranty** (from the date of shipment)

- Pneumatic Table Lift
- Electric Table Lift

**5-year Warranty** (from the date of manufacture)

- Triple Play Series
- Electrical Components
- Pneumatic Cylinders
- Textiles, Foam, and Decorative Trim
- Swivel Arm Pads
- Keyboard Kits
- Lighting
- All Height Adjustable Mechanisms

**3-year Warranty** (from date of shipment)

- Dock 950 Wireless Charger
- Dock 150 Wireless and USB Charger

**THIS WARRANTY DOES NOT COVER:**

- Damage caused by a carrier or third party
- Normal or routine wear and tear
- Appearance, durability, quality, behavior, colorfastness, or any other attribute of customer’s own materials or any non-standard Indiana Furniture material (including CF Stinson, Maharam, Momentum, Mayer, UltraFabrics, Architex, and other alliance programs) specified by the customer and applied to a Product
- Color, grain or texture of wood, laminate and other covering materials
- Changes in wood or fabric color due to aging or exposure to light

As the manufacturer of the Product, Indiana Furniture stands behind its craftsmanship and pledges to do everything it can to reasonably resolve, as quickly as possible, any problems you may have with the Product within the terms and conditions of this warranty.

If you encounter a defect covered by the foregoing warranty, contact the dealer from whom you purchased the Product. If the dealer is unable to resolve your warranty issues, you should contact Indiana Furniture. Please ensure that you have all of the pertinent facts when contacting the dealer or Indiana Furniture, including the model number and factory order number from the inspection label attached to the Product.

INDIANA FURNITURE IS NOT PROVIDING, AND SPECIFICALLY DISCLAIMS, ANY OTHER WARRANTIES FOR THE PRODUCTS, EXPRESS OR IMPLIED, INCLUDING ANY IMPLIED WARRANTY OF MERCHANTABILITY OR FITNESS FOR A PARTICULAR PURPOSE. INDIANA FURNITURE SHALL NOT BE LIABLE TO THE PURCHASER OR ANY THIRD PARTY FOR CONSEQUENTIAL, INCIDENTAL, INDIRECT, OR SPECIAL DAMAGES, INCLUDING, WITHOUT LIMITATION, DAMAGES ARISING OUT OF OR RESULTING IN ANY MALFUNCTIONS, DELAYS, LOSS OF PROFIT, INTERRUPTION OF BUSINESS, PERSONAL INJURY, BODILY INJURY, DEATH, DISMEMBERMENT, OR PROPERTY DAMAGE.

Indiana Furniture Industries, Inc.  
Attn: Customer Service  
1224 Mill Street, P.O. Box 270  
Jasper, Indiana 47547-0270  
800.422.5727  
Fax 812.482.9035  
custserv@indianafurniture.com



# Tables+Storage



Finely crafted in select American hardwood veneers, Allegiance celebrates smart looks at an affordable price, while skillfully maintaining our expert craftsmanship and attention to every detail. Pair with Allegiance Casegoods to create a cohesive look throughout an entire facility.

**CONSTRUCTION**

*Allegiance features a Veneer chassis, where applicable, with your choice of either a Veneer or HPL top. Units ship assembled unless otherwise noted.*

**VENEER**

- Exposed surfaces feature select grade, plain sliced American Black Walnut and Cherry hardwood veneers, carefully selected and matched to assure proper balance and consistency

**TOPS**

- Wood Veneer worksurfaces are 5-ply balanced construction, 1" thick with solid hardwood rims
- High Pressure Laminate (HPL) worksurfaces are 3-ply balanced construction, 1" thick with solid hardwood rims
- Worksurfaces feature shaped edge profiles on all four sides
- Grain direction runs left to right, unless otherwise noted

**CHASSIS**

- Veneer Chassis is constructed of American Black Walnut or Cherry hardwood veneer
- Chassis is securely fastened using high quality European fastening systems and heavy-duty, 16-gauge joining brackets to assure maximum strength
- All units ship with heavy-duty, adjustable leveling glides to ensure proper leveling and compensation for uneven floors

**DRAWERS**

- All drawer fronts are standard with matched wood grain faces
- All drawers feature 5-sided construction allowing for easy removal of drawer fronts
- Fronts are 3-ply construction and are 3/4" thick
- Sides and backs are wood-grain vinyl wrapped and are 1/2" thick
- Box and file drawers have 1/8" thick hardboard bottoms and tested for 100lb capacity
- Lateral file drawers feature 1/4" thick bottoms and tested for 200lb capacity
- All drawers feature full extension, progressive action slides with precision steel ball bearings
- All suspensions have a limited lifetime warranty

**FILING**

- All file drawers are standard with filing systems designed to accommodate a variety of filing requirements
- Letter width file drawers provide letter filing front to back, and letter or legal filing side to side

**STORAGE**

- All hinged doors include soft close hinges, unless otherwise noted
- One piece hinge and base plate combination
- Soft close hinges reduce stress placed on the cabinet when the door is closed and offers a quiet closure

**LOCKING**

- All credenzas and storage cabinets feature locking drawers
- Removable lock cylinders allow for units to be re-keyed at a later date, if required
- Units are shipped randomly keyed as standard
- Keyed alike units are available upon request at no additional charge
- Lock core will match pull color

**INTERIOR DRAWER DIMENSIONS & FILING CAPABILITIES**

| Model             | W       | L        | D       |
|-------------------|---------|----------|---------|
| 11-2472SC Drawers | 12 1/8" | 16 3/16" | 9 5/16" |



Letter Front to Back

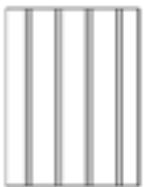

Legal Side to Side

| Model               | W        | L        | D       |
|---------------------|----------|----------|---------|
| 11-3672SU2 Lat File | 32 9/32" | 15 1/16" | 9 7/32" |

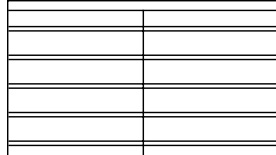

2 Rows Letter Front to Back

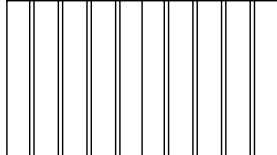

1 Row Legal Side to Side

| Model               | W        | L        | D       |
|---------------------|----------|----------|---------|
| 11-3072SU2 Lat File | 26 7/32" | 15 1/16" | 9 7/32" |

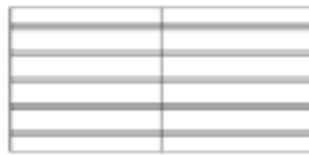

2 Rows Letter or Legal Front to Back



1 Row Letter or Legal Side to Side

**HOW TO ORDER EXAMPLES**

| Model No. | QTY | Description   | Example   |
|-----------|-----|---------------|-----------|
| 11-4242CT | 1   | Top Material  | W         |
|           |     | Finish        | SCH       |
|           |     | Edge Profile  | X         |
| 01-2020CB | 1   | Finish        | SCH       |
|           |     | Grommet/Color | GCBIS/BLK |
| 11-2472SC | 1   | Top Material  | P         |
|           |     | Finish        | CO        |
|           |     | Edge Profile  | X         |
|           |     | Pull          | NBT       |

### veneer (W) OPTIONS

Veneer features UVAdvantage, an ultra-violet finish, on all exposed surfaces by utilizing roll-coat UV technology.

|     |                    |     |                     |
|-----|--------------------|-----|---------------------|
| AW  | Artisan Walnut     | HW  | Harvest Walnut      |
| CO  | Columbian Walnut   | LW  | Legacy Walnut       |
| DC  | Dark Cherry        | MW  | Mahogany Walnut     |
| DFW | Dark Forest Walnut | SCH | Select Cherry       |
| EW  | Espresso           | SKC | Shaker Cherry       |
| GC  | Golden Cherry      | WC  | Williamsburg Cherry |

### HPL (P) LAMINATE WORKSURFACE OPTIONS

#### WOODGRAIN

|    |                  |     |                     |
|----|------------------|-----|---------------------|
| CO | Columbian Walnut | SCH | Select Cherry       |
| EF | Espresso         | SKC | Shaker Cherry       |
| GC | Golden Cherry    | WC  | Williamsburg Cherry |
| MW | Mahogany Walnut  |     |                     |

### EDGE PROFILES

|   |        |
|---|--------|
| X | Flute  |
| Y | Square |
| Z | Tail   |



Flute (X)

Square (Y)

Tail (Z)

### LOCKING DOORS

Locking doors are available on select models. You must specify WITH LOCKING when ordering and add upcharge.

|        |                   |    |    |
|--------|-------------------|----|----|
| LKT_HU | 36"W - 30"W Units | \$ | 85 |
| LKT_HU | 18"W Unit         | \$ | 65 |

### PULL OPTIONS

Note: Lock Core will match Pull Color

|     |                  |     |                  |
|-----|------------------|-----|------------------|
| AAC | Arc, Aluminum    | AEL | Elite, Aluminum  |
| BAC | Arc, Black       | BEL | Elite, Black     |
| ABM | Beam, Aluminum   | FPL | Finger           |
| BBM | Beam, Black      | AFL | Flair, Aluminum  |
| BBT | Bow Tie, Black   | CFL | Flair, Chrome    |
| NBT | Bow Tie, Nickel  | AFC | Focus, Aluminum  |
| ABU | Buckle, Aluminum | BFC | Focus, Black     |
| BBU | Buckle, Black    | AQD | Quadra, Aluminum |
|     |                  | BQD | Quadra, Black    |



### CERTIFICATIONS & COMPLIANCE

- Intertek Sustainability Certified
- BIFMA level® Certified
- BIFMA Compliant® Certified
- TSCA Title VI (formerly CARB) Compliance
- US Green Building's LEED® Contribution

### Tops and Bases



Circular Tops  
[\(See Details\)](#)



Disc Bases  
[\(See Details\)](#)

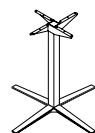

Small and Large X  
Bases [\(See Details\)](#)

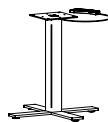

HA Pneumatic X  
Bases [\(See Details\)](#)



Metal Bases  
[\(See Details\)](#)



Strut Legs  
[\(See Details\)](#)

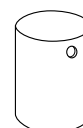

Cylinder Bases  
[\(See Details\)](#)

### Storage Components

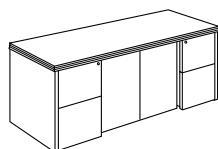

Storage Credenzas  
[\(See Details\)](#)



Wardrobe/Storage  
[\(See Multiple Unit  
Details\)](#)

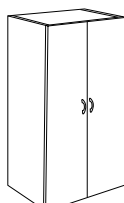

Double Wardrobe/ Storage  
[\(See Multiple Unit Details\)](#)

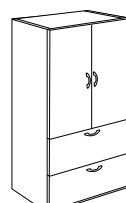

Double Wardrobe/Storage with Lateral Files  
[\(See Multiple Unit Details\)](#)

For additional solutions for desking, storage, and accessories, see the [Allegiance Casegoods](#) and [Accessories](#) Price Lists.

| Item  | Model No.                           | Width | Depth | Height | Ship Wt | Cubic Ft | List Price           |
|---|-------------------------------------|-------|-------|--------|---------|----------|----------------------|
|  | 11-4848CT                           | 48    | 48    | 1      | 95      | 4.3      | P\$ 1506<br>W\$ 1956 |
|   | <i>Accommodates Five (5) Chairs</i> |       |       |        |         |          |                      |
|   | 11-4242CT                           | 42    | 42    | 1      | 40      | 4.4      | P\$ 1394<br>W\$ 1790 |
| <i>Accommodates Four (4) Chairs</i>   |                                     |       |       |        |         |          |                      |
|   | 11-3636CT                           | 36    | 36    | 1      | 35      | 3.4      | P\$ 1288<br>W\$ 1640 |
| <i>Accommodates Three (3) Chairs</i>  |                                     |       |       |        |         |          |                      |

Must Specify (in this order):

- Model #
- Top Material
- Finish/Color
- Edge Profile

**Description**

- Single Base or Four (4) Strut Legs (on 48" Top Only) Required; Ordered Separately ([See Strut Leg Details](#))
- Power Options not Available

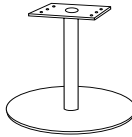
| DISC BASE   | For 48" Circular Tops         |          |    |    |     |    |     |         |
|---|-------------------------------|----------|----|----|-----|----|-----|---------|
|  | 01-3230DBB                    | Black    | 30 | 30 | 27¾ | 42 | 4.1 | \$ 1728 |
|   | 01-3230DBA                    | Aluminum | 30 | 30 | 27¾ | 42 | 4.1 | \$ 1728 |
|   | For 36" and 42" Circular Tops |          |    |    |     |    |     |         |
|   | 01-2430DBB                    | Black    | 24 | 24 | 27¾ | 32 | 3.2 | \$ 1440 |
|   | 01-2430DBA                    | Aluminum | 24 | 24 | 27¾ | 32 | 3.2 | \$ 1440 |

**Description**

- 4" Diameter Column

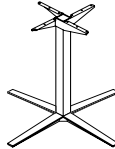
| METAL X-BASE   | For 42" and 48" Circular Tops |          |     |     |    |    |      |         |
|--|-------------------------------|----------|-----|-----|----|----|------|---------|
|  | 08-2642LXB                    | Aluminum | 35½ | 35½ | 40 | 33 | 20.0 | \$ 1240 |
|  | <i>For 42" High Tables</i>    |          |     |     |    |    |      |         |
|  | 08-2636LXB                    | Aluminum | 35½ | 35½ | 34 | 30 | 17.2 | \$ 1196 |
|  | <i>For 36" High Tables</i>    |          |     |     |    |    |      |         |
|  | 08-2630LXB                    | Aluminum | 35½ | 35½ | 28 | 27 | 14.5 | \$ 1144 |
|  | <i>For 30" High Tables</i>    |          |     |     |    |    |      |         |
|  | For 36" Circular Tops         |          |     |     |    |    |      |         |
|  | 08-2042SXB                    | Aluminum | 29½ | 29½ | 40 | 27 | 15.9 | \$ 1158 |
| <i>For 42" High Tables</i>   |                               |          |     |     |    |    |      |         |
|  | 08-2036SXB                    | Aluminum | 29½ | 29½ | 34 | 24 | 13.7 | \$ 1112 |
| <i>For 36" High Tables</i>   |                               |          |     |     |    |    |      |         |
|  | 08-2030SXB                    | Aluminum | 29½ | 29½ | 28 | 21 | 11.6 | \$ 1068 |
| <i>For 30" High Tables</i>   |                               |          |     |     |    |    |      |         |

**Description**

- Not Available to Be Sold Separately

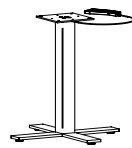
| HEIGHT ADJUSTABLE PNEUMATIC X-BASE  | For 48" Circular Tops |          |    |    |        |   |     |         |
|---|-----------------------|----------|----|----|--------|---|-----|---------|
|  | 01-3232HAXBB          | Black    | 32 | 32 | 26-45¾ | 1 | 0.2 | \$ 1615 |
|   | 01-3232HAXBA          | Aluminum | 32 | 32 | 26-45¾ | 1 | 0.2 | \$ 1615 |
|   | For 36" Circular Tops |          |    |    |        |   |     |         |
|   | 01-2626HAXBB          | Black    | 22 | 22 | 26-45¾ | 1 | 0.2 | \$ 1583 |
|   | 01-2626HAXBA          | Aluminum | 22 | 22 | 26-45¾ | 1 | 0.2 | \$ 1583 |

**Description**

- Pre-Drilled Boring Pattern May Not Match Underside of Table Top
- Steel Mounting Plate: 8"x 8"x ¼"
- Eight (8) \*MM Bolts Included for Assembly
- Ships KD

P = HPL W = Veneer

[See Allegiance Overview For Ordering Options](#)



**ALLEGIANCE™**  
SMALL MEETING TABLES (1100 SERIES)

| Item              | Model No.  |          | Width | Depth | Height | Ship Wt | Cubic Ft | List Price |
|-------------------|------------|----------|-------|-------|--------|---------|----------|------------|
| <b>METAL BASE</b> | 01-0400MBB | Black    | 32    | 32    | 27¾    | 32      | 3.2      | \$ 936     |
|                   | 01-0400MBA | Aluminum | 32    | 32    | 27¾    | 32      | 3.2      | \$ 936     |



Open Market Only

**Description**  
 • Shipped KD; Some Assembly Required

|                         |             |          |    |     |     |    |     |         |
|-------------------------|-------------|----------|----|-----|-----|----|-----|---------|
| <b>STRUT TABLE LEGS</b> | 01-2228STR4 | (4 Legs) | 1½ | 22½ | 28⅞ | 64 | 9.0 | \$ 2398 |
|-------------------------|-------------|----------|----|-----|-----|----|-----|---------|



Must Specify (in this order):  
 Model # and Quantity  
 Color

**Description**  
 • Available in Aluminum (ALUM) or Black (BLK); Must Specify Color  
 • Each Leg has Adjustable Glides  
 • Legs not Available To Be Sold Separately  
 • For Use with Indiana Furniture Tops Only; 48" or Larger

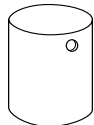
| <b>CYLINDER BASE</b>   | For Tables 42"D to 48"D |  |    |    |     |     |      |          |
|--|-------------------------|--|----|----|-----|-----|------|----------|
|  | 01-2020CB               |  | 20 | 20 | 28½ | 136 | 10.9 | W\$ 1456 |
|  | For Tables 36"D         |  |    |    |     |     |      |          |
|  | 01-1616CB               |  | 16 | 16 | 28½ | 101 | 7.2  | W\$ 1331 |

Must Specify (in this order):  
 Model #  
 Finish  
 Grommet Options

**Description**  
 • Veneer Base Features Multi-Step, Hand-Finished Catalyzed Finish  
 • Weighted for Stability  
 • Two (2) Wire Management Black Grommets Standard at Top Edge; 8" Opening Standard at Bottom

**Additional Grommet Options: Specify & Add**

|       |                                  |    |     |
|-------|----------------------------------|----|-----|
| GCB1S | Only One (1) Grommet At Top Edge | \$ | N/C |
| NOGC  | No Grommets At Top Edge          | \$ | N/C |

|                         |           |  |    |    |    |     |      |                      |
|-------------------------|-----------|--|----|----|----|-----|------|----------------------|
| <b>STORAGE CREDENZA</b> | 11-2472SC |  | 72 | 24 | 30 | 281 | 34.2 | P\$ 4283<br>W\$ 4773 |
|-------------------------|-----------|--|----|----|----|-----|------|----------------------|

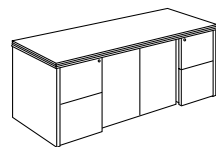

Must Specify (in this order):  
 Model #  
 Top Material  
 Finish/Color  
 Edge Profile  
 Pull

**Description**  
 • Standard with: Locking Letter Width File/File Pedestals, Non-Locking Recessed Doors  
 • 14" Fixed Storage Shelf Behind Doors

P = HPL W = Veneer

[See Allegiance Overview For Ordering Options](#)

| Item                     | Model No.    | Width     | Depth | Height | Ship Wt | Cubic Ft | List Price |         |
|--------------------------|--------------|-----------|-------|--------|---------|----------|------------|---------|
| WARDROBE/STORAGE CABINET | Hinged Left  |           |       |        |         |          |            |         |
|                          | Hinged Right |           |       |        |         |          |            |         |
|                          | 11-1872WL    | 11-1872WR | 18    | 24     | 70%     | 152      | 19.2       | \$ 2873 |

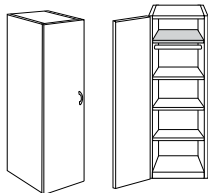

Shown as Left

Must Specify (in this order):

- Model #
- Finish
- Pull
- Locking Doors

**Description**

- Four (4) Shelves: Shaded Fixed Top Shelf and Three (3) Adjustable Shelves
- Coat Rod Under Fixed Shelf
- Adjustable Shelves can be Removed for Wardrobe Application
- Pull Installed Vertically ([See Pull Options](#)); Capsule Pull will be Substituted for Elite, Buckle, and Flair Pulls
- Optional Locking Door ([See Details](#)); Lock Core Color will Coordinate with Pull Selection

|                                 |           |    |    |     |     |      |         |
|---------------------------------|-----------|----|----|-----|-----|------|---------|
| DOUBLE WARDROBE/STORAGE CABINET | 11-3672WC | 36 | 24 | 70% | 320 | 42.0 | \$ 4088 |
|                                 | 11-3072WC | 30 | 24 | 70% | 240 | 35.7 | \$ 4015 |

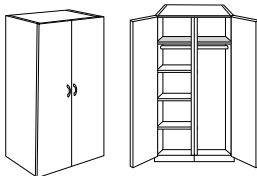

**Description**

- Left - Three (3) Adjustable Shelves; Right - Wardrobe with Coat Rod
- Shaded Shows Fixed Top Shelf Both Sides
- Pull Installed Vertically ([See Pull Options](#)); Capsule Pull will be Substituted for Elite, Buckle, and Flair Pulls
- Optional Locking Door ([See Details](#)); Lock Core Color will Coordinate with Pull Selection

Must Specify (in this order):

- Model #
- Finish
- Pull
- Locking Doors

|  |            |    |    |     |     |      |         |
|--|------------|----|----|-----|-----|------|---------|
| DOUBLE WARDROBE/STORAGE CABINET WITH LATERAL FILES | 11-3672SU2 | 36 | 24 | 70% | 298 | 42.0 | \$ 4294 |
|  | 11-3072SU2 | 30 | 24 | 70% | 251 | 35.7 | \$ 4217 |

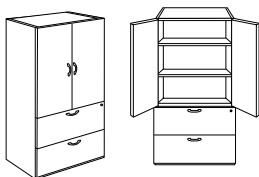

**Description**

- Top - Two (2) Doors with Two (2) Adjustable Shelves Behind Doors
- Bottom - Locking Lateral Drawers
- Lateral Drawers Provide Legal or Letter Filing Front to Back or Side to Side
- Pull Installed Vertically ([See Pull Options](#)); Capsule Pull will be Substituted for Elite, Buckle, and Flair Pulls
- Optional Locking Door ([See Details](#)); Lock Core Color will Coordinate with Pull Selection

Must Specify (in this order):

- Model #
- Finish
- Pull
- Locking Doors

[See Allegiance Overview For Ordering Options](#)

Arlington offers all the grace and embellishments associated with traditional styling with an added emphasis on value. Finely crafted in select solids with walnut and cherry veneers and high pressure laminate worksurfaces, Arlington ensures quality and expert craftsmanship with a selection of configurations for today's functional workspaces.

**CONSTRUCTION**

*Arlington features a Veneer chassis with your choice of a Veneer or HPL top. Units ship assembled unless otherwise noted.*

**VENEER**

- Exposed surfaces feature select grade, plain sliced American Black Walnut or Cherry veneers, carefully selected and matched to assure proper balance and consistency

**TOPS**

- Veneer tops are 5-ply balanced construction and 1 3/16" thick with solid hardwood rims with butt corners
- High Pressure Laminate (HPL) tops are 3-ply balanced construction and 1 3/16" thick with solid hardwood rims with butt corners
- Grain direction runs left to right unless noted

**CHASSIS**

- Chassis is securely fastened using high quality European fastening systems and heavy-duty, 16-gauge joining brackets to assure maximum strength
- All units ship with heavy-duty, adjustable leveling glides to ensure proper leveling and compensation for uneven floors
- Bases are solid hardwood with mitered corners
- Construction offers tight tolerances and long term durability
- Vertical grain direction on chassis

**DRAWERS**

- Drawer fronts standard with matched veneer faces
- Drawer sides, back and front are woodgrain vinyl-wrapped, and are 1/2" thick
- 5-sided drawer construction for easy removal of drawer front
- Box and file drawers have 1/8" thick hardboard bottoms and tested for 100lb capacity
- Lateral file drawers feature 1/4" thick bottoms and tested for 200lb capacity
- All drawers feature full extension, progressive action slides with precision steel ball bearings
- All suspensions have a limited lifetime warranty

**FILING**

- All file drawers are standard with filing systems designed to accommodate a variety of filing requirements
- Letter width file drawers provide letter filing front to back and legal filing side to side
- Lateral file drawers provide legal or letter filing front to back or side to side

**STORAGE**

- All hinged doors include soft close hinges, unless noted
- One piece hinge and base plate combination
- Soft close hinges reduce stress placed on the cabinet when the door is closed and offers a quiet closure

**LOCKING**

- See [locking details](#) for locking door and drawer options
- Lock core available in black or silver and will coordinate with pull selection; See [locking details](#)
- Removable lock cylinders allow for units to be re-keyed at a later date if required
- Units are shipped randomly keyed as standard. Keyed alike units available upon request at no additional charge.

**CORD MANAGEMENT**

- Grommets are available in black or silver, please specify color
- See [optional grommet locations](#)
- Undersurface Wire Managers available for additional cord management; See [Accessories](#)

**INTERIOR DRAWER DIMENSIONS & FILING CAPABILITIES**

**Model**

29-2072SC      29-2066SC

**Drawers**

|      | <b>W</b> | <b>L</b> | <b>D</b> |
|------|----------|----------|----------|
| Box  | 15 3/8"  | 16 1/2"  | 3 21/32" |
| File | 15 3/8"  | 16 1/2"  | 8 29/32" |

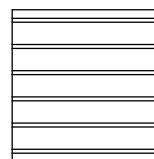

Legal Front to Back

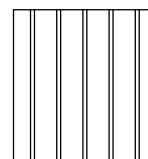

Legal Side to Side

**Model**

29-2072DL

**Drawers**

|              | <b>W</b> | <b>L</b> | <b>D</b> |
|--------------|----------|----------|----------|
| Lateral File | 24 7/8"  | 16 1/2"  | 9 17/32" |

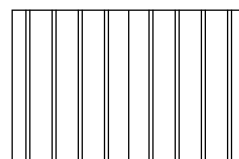

1 Row Letter or Legal Side to Side

**HOW TO ORDER EXAMPLES**

|                 | <b>QTY</b> | <b>Model No.</b> | <b>Description</b>              | <b>Example</b> |
|-----------------|------------|------------------|---------------------------------|----------------|
| <b>TOP/BASE</b> | 1          | 29-4296RT        | Top Material                    | W              |
|                 |            |                  | Finish                          | CO             |
|                 |            |                  | Grommet/Power/<br>Data Location | OC             |
|                 |            |                  | Finish                          | CO             |
| <b>BASES</b>    | 1          | 29-2828TB        | Finish                          | CO             |
| <b>PORT</b>     | 1          | 01-INTRFCIA      |                                 |                |
| <b>CREDENZA</b> | 1          | 29-2072SC        | Top Material                    | W              |
|                 |            |                  | Finish                          | CO             |
|                 |            |                  | Base Molding                    | BM3600         |
|                 |            |                  | Decorative Molding              | M3600          |
|                 |            |                  | Pull                            | ARA            |
|                 |            |                  | Locking                         | LKT-HU         |
|                 |            |                  | Drawer Construction             | STD            |

**VENEER (W) OPTIONS**

Veneer features UVAdvantage, an ultra-violet finish, on all exposed surfaces by utilizing roll-coat UV technology.

*Note: Base and decorative molding feature multi-step, hand-finished catalyzed finish.*

|     |                    |     |                     |
|-----|--------------------|-----|---------------------|
| AW  | Artisan Walnut     | HW  | Harvest Walnut      |
| CO  | Columbian Walnut   | LW  | Legacy Walnut       |
| DC  | Dark Cherry        | MW  | Mahogany Walnut     |
| DFW | Dark Forest Walnut | SCH | Select Cherry       |
| EW  | Espresso           | SKC | Shaker Cherry       |
| GC  | Golden Cherry      | WC  | Williamsburg Cherry |

**HPL (P) TOP OPTIONS**

**WOODGRAIN**

|    |                  |     |                     |
|----|------------------|-----|---------------------|
| CO | Columbian Walnut | MW  | Mahogany Walnut     |
| EF | Espresso         | SCH | Select Cherry       |
| GC | Golden Cherry    | SKC | Shaker Cherry       |
|    |                  | WC  | Williamsburg Cherry |

**EDGE PROFILES**

R Arlington



**MOLDING LOCATIONS AND OPTIONS**

**Base Molding**

Arlington and Wilmington Base Molding are skillfully applied on Credenzas to front and both sides with no molding on back for flush wall applications.



Arlington Base Molding



Wilmington Base Molding

**Decorative Molding**

Optional Decorative Molding is available with the Wilmington Base Molding package. Credenzas will feature decorative molding on the left and right sides only.



Wilmington Decorative Molding



No Decorative Molding

Molding selection must be specified on order.

**Arlington Molding**

BM2900 Arlington Base Molding \$ N/C

**Wilmington Molding**

BM3600 Wilmington Base Molding \$ N/C

M3600 Optional Wilmington Decorative Molding \$ 130

*Note: Base and Decorative Molding features multi-step, hand-finished catalyzed finish*

**DRAWER AND DOOR PULL OPTIONS**

Units with doors and drawers will feature coordinating pulls however door and drawer pulls cannot be intermixed.

|     |                            |     |                          |
|-----|----------------------------|-----|--------------------------|
| ARA | Arlington A, Antique Brass | JEF | Jefferson, Antique Brass |
| ARB | Arlington B, Antique Brass | ALB | Liberty, Aluminum        |
| WLM | Wilmington, Antique Brass  |     |                          |



**Arlington A (ARA)**  
Antique Brass - 5/4"



**Arlington B (ARB)**  
Antique Brass - 5/4"



**Jefferson (JEF)**  
Antique Brass - 5/4"



**Wilmington (WLM)**  
Antique Brass - 5/4"



**Liberty (ALB)**  
Aluminum - 4/4"

**LOCK CORE OPTIONS**

Lock core will be black if Arlington, Wilmington or Jefferson pulls are selected. Lock core will be silver if Liberty Pulls are selected.

|     |        |
|-----|--------|
| BLK | Black  |
| SLV | Silver |



Black (BLK)



Silver (SLV)

**CREDENZA LOCKING DOORS AND DRAWERS**

Locking doors and drawers are available on credenzas. Please specify applicable code on order with model/unit and add upcharge.

Storage credenzas offer locking pedestals and locking doors with the lock positioned in the face of the drawer nearest to doors. Door lock is positioned in top right corner of left door.

|        |   |        |
|--------|---|--------|
| LKT_P  | Double Pedestal Lock                    | \$ 384 |
| LKT_HU | Double Pedestal and Double Door Locking | \$ 461 |

**LOCKING DOORS**

Locking doors are available on specific units, where noted. You must specify WITH LOCKING when ordering and add upcharge.

|        |                    |       |
|--------|--------------------|-------|
| LKT_HU | 36"W to 28"W Units | \$ 85 |
| LKT_HU | 18"W Units         | \$ 65 |

**DRAWER OPTIONS**

Units with drawers come standard with woodgrain vinyl-wrapped drawers with mitered corners. Optional wood dove tail construction for all box, file, and lateral file drawers is available. Must specify when ordering.

**Pricing is per Drawer, not per Model/Unit.**

|       |                             |    |     |
|-------|-----------------------------|----|-----|
| MITER | Mitered Fold Construction   |    | STD |
| DOVE  | Wood Dove Tail Construction | \$ | 42  |

**CONFERENCE AND MEETING TABLE GROMMET OPTIONS**

Arlington Meeting and Conference Tables offer Power/Data and grommets at a variety of locations. Available Power/Data and Grommets may be found on Pages 21 to 23

**Must Specify Black (BLK) or Silver (SLV)**

**Grommet Locations**

|    |                     |    |                        |
|----|---------------------|----|------------------------|
| OC | On Center           | CL | 5½" Left of Center     |
| EL | 24½" from Left End  | CR | 5½" Right of Center    |
| ER | 24½" from Right End | BB | Centered Between Bases |

**Panel Base Location Availability by Top Size**

|            |  |   |
|------------|--|---|
| 96"W Tops  | OC, EL+ER                                    |  |
| 120"W Tops | BB, CL, CR, CL+EL+ER, CR+EL+ER               |   |
| 144"W Tops | BB, CL, CR, CL+CR, EL+ER, CL+EL+ER, CR+EL+ER |   |

Power and Grommet Units only available **On Center (OC)** when Queen Anne Bases are selected.



Arlington Work Tables offer grommets at left/right and on center locations.

**Must Specify Black (BLK) or Silver (SLV) Grommets**

|  |   | Per Grommet |
|--|---|-------------|
| <b>Locations Availability by Model</b> |   | \$ 72       |
| 29-3672WT                              | GL/GR: Grommet Left and Right; 12" from end and 23" from user (Requires 2 grommets) |             |
|  | GC: Grommet Center; 23" from user   |             |
| 29-3060WT                              | GL/GR: Grommet Left and Right; 9" from end and 23" from user (Requires 2 grommets)  |             |
|  | GC: Grommet Center; 9" from user  |             |

**CERTIFICATIONS & COMPLIANCE**

- Intertek Sustainability Certified
- BIFMA level® Certified
- BIFMA Compliant® Certified
- TSCA Title VI (formerly CARB) Compliance
- US Green Building's LEED® Contribution

**Tops and Tables**



Circular Tops  
[\(See Details\)](#)



1-Piece Rectangle Tops  
[\(See Details\)](#)



2-Piece Rectangle Tops  
[\(See Details\)](#)

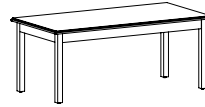

Work Tables  
[\(See Details\)](#)

**Bases**

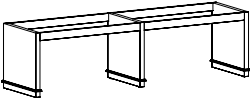

Rectangle Bases  
1-Pc Top [\(See Details\)](#)  
2-Pc Top [\(See Details\)](#)

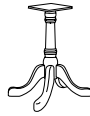

Queen Anne Bases  
Circular Tops [\(See Details\)](#)  
1-Pc Top [\(See Details\)](#)  
2-Pc Top [\(See Details\)](#)

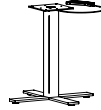

Height Adjustable Pneumatic  
X-Bases [\(See Details\)](#)

**Storage Components**

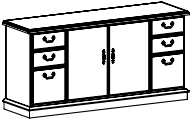

Storage Credenza  
[\(See Details\)](#)

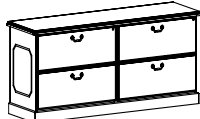

Credenza with Double Lateral  
[\(See Details\)](#)



Door Bookcases  
[\(See Details\)](#)



Wardrobe/Storage  
[\(See Details\)](#)

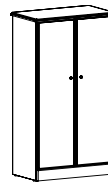

Double Wardrobe/Storage  
[\(See Details\)](#)

**[Wire Management & Power/Data Accessories](#)**

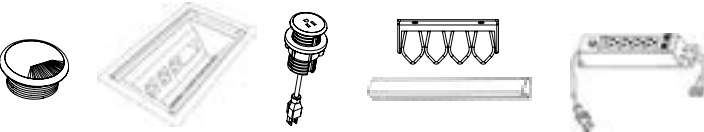

For additional solutions for desking, storage, and accessories, see the [Arlington Casegoods](#) and [Accessories](#) Price Lists.

| Item  | Model No.   | Width | Depth | Height | Ship Wt | Cubic Ft | List Price           |
|---|---|-------|-------|--------|---------|----------|----------------------|
|  | 29-4848CT<br><i>Accommodates Five (5) Chairs</i>  | 48    | 48    | 30     | 58      | 5.9      | P\$ 2462<br>W\$ 2892 |
|   | 29-4242CT<br><i>Accommodates Four (4) Chairs</i>  | 42    | 42    | 30     | 51      | 4.5      | P\$ 1716<br>W\$ 2108 |
|   | 29-3636CT<br><i>Accommodates Three (3) Chairs</i> | 36    | 36    | 30     | 50      | 3.3      | P\$ 1491<br>W\$ 1838 |

Top Must Specify (in this order):

- Model #
- Top Material
- Finish/Color

Base Must Specify (in this order):

- Model #
- Finish/Color

**Description**

- Available with Veneer (W) or HPL (P) Top, Must Specify
- See Below for Queen Anne Base and Height Adjustable Pneumatic X-Base; Order Separately
- Power Options not Available

**Base Options: Must Order & Add**

**Queen Anne Base**

|           |                                       |    |      |         |
|-----------|---------------------------------------|----|------|---------|
| 01-0606QB | Optional Queen Anne Base (1 Required) | 54 | 22.4 | \$ 1318 |
|-----------|---------------------------------------|----|------|---------|



**Description**

- Queen Anne Base Features Multi-Step, Hand-Finished Catalyzed Finish
- Four Legs with Adjustable Glides

**Height Adjustable Pneumatic X-Bases**

**Maximum Round 42", Maximum Square 36"**

|              |          |    |    |        |   |     |         |
|--------------|----------|----|----|--------|---|-----|---------|
| 01-3232HAXBB | Black    | 32 | 32 | 26-45¾ | 1 | 0.2 | \$ 1615 |
| 01-3232HAXBA | Aluminum | 32 | 32 | 26-45¾ | 1 | 0.2 | \$ 1615 |



**Maximum Round 36", Maximum Square 30"**

|              |          |    |    |        |   |     |         |
|--------------|----------|----|----|--------|---|-----|---------|
| 01-2626HAXBB | Black    | 22 | 22 | 26-45¾ | 1 | 0.2 | \$ 1583 |
| 01-2626HAXBA | Aluminum | 22 | 22 | 26-45¾ | 1 | 0.2 | \$ 1583 |

**Description**

- Pre-Drilled Boring Pattern May Not Match Underside of Table Top
- Steel Mounting Plate: 8"x 8"x ¼"
- Eight (8) \*MM Bolts Included for Assembly
- Ships KD

| Item  | Model No.   | Width | Depth | Height | Ship Wt | Cubic Ft | List Price           |
|---|---|-------|-------|--------|---------|----------|----------------------|
|  | 29-4296RT<br><i>Accommodates Eight (8) Chairs</i> | 96    | 42    | 30     | 140     | 12.5     | P\$ 3493<br>W\$ 4116 |
|   | 29-3672RT<br><i>Accommodates Six (6) Chairs</i>   | 72    | 36    | 30     | 91      | 6.6      | P\$ 2894<br>W\$ 3373 |

Must Specify (in this order):

- Model #
- Top Material
- Finish/Color
- Grommet/Power/Data Location
- Base Model #
- Base Finish

**Description**

- One (1) Piece Top
- Available with Veneer (W) or HPL (P) Top, Must Specify
- Top and Bases Shipped Separately
- Bases Must Specified. Top Price Includes Standard Two (2) Rectangle Bases with Two (2) Stretchers, Optional Queen Anne Bases Available (See Below)
- Queen Anne Base Features Multi-Step, Hand-Finished Catalyzed Finish
- Optional Power/Data/Grommets are Available ([See Details](#)), Must Order Separately

**Options: Must Specify and Add**

|           |  |     |      |          |
|-----------|--|-----|------|----------|
| 29-2828TB | Rectangular Bases<br>(Includes Two (2) Bases and Two (2) Stretchers) | 104 | 7.0  | Included |
| 01-0606QB | Queen Anne Base Upgrade<br>(Includes Two (2) Bases)                  | 54  | 22.4 | \$ 884   |

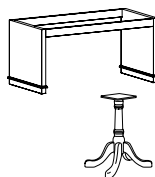

P = HPL W = Veneer

[See Arlington Overview For Ordering Options](#)

| Item  | Model No.  | Width | Depth | Height | Ship Wt | Cubic Ft | List Price           |
|---|--|-------|-------|--------|---------|----------|----------------------|
|  | 29-48144RT<br><i>Accommodates Twelve (12) Chairs</i> | 144   | 48    | 30     | 315     | 22.0     | P\$ 7233<br>W\$ 8274 |
|   | 29-48120RT<br><i>Accommodates Ten (10) Chairs</i>    | 120   | 48    | 30     | 198     | 22.0     | P\$ 4405<br>W\$ 5238 |

Must Specify (in this order):

- Model #
- Top Material
- Finish/Color
- Grommet/Power/Data Location
- Base Model #
- Base Finish

**Description**

- Two (2) Piece Top
- Available with Veneer (W) or HPL (P) Top, Must Specify
- Top and Bases Shipped Separately
- Bases Must Specified. Top Price Includes Standard Two (2) Rectangle Bases with Two (2) Stretchers, Optional Queen Anne Bases Available (See Below)
- Queen Anne Base Features Multi-Step, Hand-Finished Catalyzed Finish
- Optional Power/Data/Grommets are Available ([See Details](#)), Must Order Separately

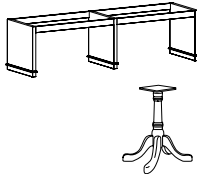

**Options: Must Specify and Add**

|           |   |     |      |          |
|-----------|---|-----|------|----------|
| 29-2828TB | Rectangular Bases<br>(Includes Three (3) Bases and Four (4) Stretchers) | 104 | 7.0  | Included |
| 01-0606QB | Queen Anne Base Upgrade<br>(Includes Three (3) Bases)                   | 80  | 33.6 | \$ 1326  |

| Item  | Model No.                         | Width | Depth | Height | Ship Wt | Cubic Ft | List Price           |
|---|-----------------------------------|-------|-------|--------|---------|----------|----------------------|
|  | 29-3672WT<br><i>64" Kneespace</i> | 72    | 36    | 30     | 125     | 11.4     | P\$ 2096<br>W\$ 2473 |
|   | 29-3060WT<br><i>52" Kneespace</i> | 60    | 30    | 30     | 89      | 8.0      | P\$ 1725<br>W\$ 2017 |

Must Specify (in this order):

- Model #
- Top Material
- Finish/Color
- Grommet Location/Color

**Description**

- Available with Veneer (W) or HPL (P) Top, Must Specify
- Left to Right Grain Direction on Worksurface
- Optional Factory-Installed, Worksurface Grommets Available; See Locations Below, Must Specify Grommet Color: Black (BLK) or Silver (SLV)
- Shipped KD; Some Assembly Required
- Optional Wire Management ([See Units](#)), Power/Data/Grommets are Available ([See Details](#)), Must Order Separately

P = HPL W = Veneer

[See Arlington Overview For Ordering Options](#)

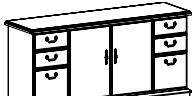

| Item   | Model No. | Width | Depth | Height | Ship Wt | Cubic Ft | List Price           |
|--|-----------|-------|-------|--------|---------|----------|----------------------|
| <b>STORAGE CREDENZA</b><br> | 29-2072SC | 72    | 20    | 30     | 237     | 30.5     | P\$ 3982<br>W\$ 4321 |
|  | 29-2066SC | 66    | 20    | 30     | 217     | 30.5     | P\$ 3458<br>W\$ 3783 |

Shown with Jefferson Drawer and Door Pulls (JEF)

Must Specify (in this order):

- Model #
- Top Material
- Finish/Color
- Base Molding
- Decorative Molding
- Pull
- Locking
- Drawer Construction

**Description**

- Standard With: Letter Width Box/Box/File in Pedestals, Left to Right Grain Direction on Worksurface
- Available with Veneer (W) or HPL (P) Top, Must Specify
- Top Profiled on only Three (3) Sides for Flush Wall Application
- Door Pull will Coordinate with Drawer Pull, [See Pull Options](#)
- Base Molding on Sides and User Side, Must Specify: Arlington or Wilmington (See Below)
- Standard with No Decorative Molding; Optional Wilmington Decorative Molding; Must Specify (See Below and [Molding Details](#))
- Optional Locking Pedestals (LKT-P) or Locking Pedestals and Doors (LKT-HU), ([See Details](#))
- Additional Options: Wood Dove Tail Drawers ([See Details](#))

**Molding Options: Must Specify and Add**

**Arlington Molding Options**

|        |                        |     |
|--------|------------------------|-----|
| BM2900 | Arlington Base Molding | N/C |
|--------|------------------------|-----|

**Wilmington Molding Options**

|        |  |        |
|--------|--|--------|
| BM3600 | Wilmington Base Molding                | N/C    |
| M3600  | Optional Wilmington Decorative Molding | \$ 130 |

*Note: Wilmington Decorative Molding may only be used with Wilmington Base Molding*

|   |           |    |    |    |     |      |                      |
|---|-----------|----|----|----|-----|------|----------------------|
| <b>CREDENZA WITH DOUBLE LATERAL FILE</b><br> | 29-2072DL | 72 | 20 | 30 | 270 | 30.5 | P\$ 4578<br>W\$ 4917 |
|---|-----------|----|----|----|-----|------|----------------------|

Shown with Jefferson Drawer and Door Pulls (JEF) and Optional Wilmington Decorative Molding

Must Specify (in this order):

- Model #
- Top Material
- Finish/Color
- Base Molding
- Decorative Molding
- Pull
- Drawer Construction

**Description**

- Standard With: Four Locking Lateral File Drawers, Left to Right Grain Direction on Worksurface
- Available with Veneer (W) or HPL (P) Top, Must Specify
- Top Profiled on only Three (3) Sides for Flush Wall Application
- Base Molding on Sides and User Side, Must Specify: Arlington or Wilmington (See Below)
- Standard with No Decorative Molding; Optional Wilmington Decorative Molding; Must Specify (See Below and [Molding Details](#))
- Additional Options: Wood Dove Tail Drawers ([See Details](#))

**Molding Options: Must Specify and Add**

**Arlington Molding Options**

|        |                        |     |
|--------|------------------------|-----|
| BM2900 | Arlington Base Molding | N/C |
|--------|------------------------|-----|

**Wilmington Molding Options**

|        |  |        |
|--------|--|--------|
| BM3600 | Wilmington Base Molding                | N/C    |
| M3600  | Optional Wilmington Decorative Molding | \$ 130 |

*Note: Wilmington Decorative Molding may only be used with Wilmington Base Molding*

P = HPL W = Veneer

[See Arlington Overview For Ordering Options](#)

| Item          | Model No. | Width | Depth | Height           | Ship Wt | Cubic Ft | List Price |
|---------------|-----------|-------|-------|------------------|---------|----------|------------|
| DOOR BOOKCASE | 29-2870DB | 28    | 15    | 70 $\frac{7}{8}$ | 78      | 17.8     | \$ 2431    |

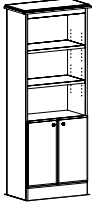

Shown with Arlington (ARB) Door Pull

**Description**

- Open Bookcase with Two (2) 1" Thick Adjustable Shelves
- Storage Behind Doors; One (1) Adjustable Shelf
- Top Profiled on only Three (3) Sides for Flush Wall Application
- Vertical Woodgrain
- Optional Locking Doors, [See Locking Options](#)

Must Specify (in this order):

- Model #
- Finish
- Pull
- Locking

| WARDROBE/STORAGE CABINET | Hinged Left | Hinged Right | Width | Depth | Height           | Ship Wt | Cubic Ft | List Price |
|--------------------------|-------------|--------------|-------|-------|------------------|---------|----------|------------|
|                          | 29-1870WL   | 29-1870WR    |       |       |                  |         |          |            |
|                          |             |              | 18    | 20    | 70 $\frac{7}{8}$ | 153     | 19.2     | \$ 2864    |

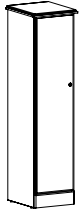

Shown as Left

**Description**

- Coat Rod Under Top Fixed Shelf and Three (3) Adjustable Shelves
- Adjustable Shelves can be Removed for Wardrobe Application
- Top Profiled on only Three (3) Sides for Flush Wall Application
- Must Specify Door Pull: Arlington B (ARB), **Jefferson (JEF)**, and Liberty (ALB)
- Vertical Woodgrain
- Optional Locking Door, [See Locking Options](#)

Must Specify (in this order):

- Model #
- Finish
- Pull
- Locking

|                                 |           |    |    |                  |     |      |         |
|---------------------------------|-----------|----|----|------------------|-----|------|---------|
| DOUBLE WARDROBE/STORAGE CABINET | 29-3670WD | 36 | 20 | 70 $\frac{7}{8}$ | 310 | 34.2 | \$ 5057 |
|---------------------------------|-----------|----|----|------------------|-----|------|---------|

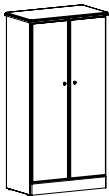

**Description**

- Three (3) Adjustable Shelves on Both Sides; Coat Rod Under Top Fixed Shelf on Right
- Recommended Against Wall
- Top Profiled on only Three (3) Sides for Flush Wall Application
- Must Specify Door Pull: Arlington B (ARB), **Jefferson (JEF)**, and Liberty (ALB)
- Vertical Woodgrain
- Optional Locking Door, [See Locking Options](#)

Must Specify (in this order):

- Model #
- Finish
- Pull
- Locking

[See Arlington Overview For Ordering Options](#)

| Item                | Model No. |        | Width             | Depth             | Height | Ship Wt | Cubic Ft | List Price |
|---------------------|-----------|--------|-------------------|-------------------|--------|---------|----------|------------|
| ROUND GROMMET COVER | 01-GRMTB  | Black  | 2 $\frac{3}{8}$ " | 2 $\frac{3}{8}$ " | -      | 1       | 0.1      | \$ 33      |
|                     | 01-GRMTSL | Silver | 2 $\frac{3}{8}$ " | 2 $\frac{3}{8}$ " | -      | 1       | 0.1      | \$ 33      |



*Open Market Only*

#### Description

- 2 $\frac{3}{8}$ " (60mm) Round Grommet Cover
- Field Installed

|                          |             |        |   |   |   |   |     |       |
|--------------------------|-------------|--------|---|---|---|---|-----|-------|
| SINGLE POWER SAND DOLLAR | 01-SAND60PS | Silver | 3 | 3 | 4 | 1 | 0.2 | \$ 92 |
|                          | 01-SAND60PW | White  |   |   |   |   |     | \$ 92 |
|                          | 01-SAND60PB | Black  |   |   |   |   |     | \$ 92 |

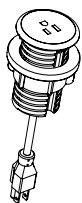

#### Description

- Mounts in 2 $\frac{3}{8}$ " (60mm) Round Grommet
- Single Power Outlet with 6' Cord

|                        |             |        |   |   |   |   |     |        |
|------------------------|-------------|--------|---|---|---|---|-----|--------|
| DOUBLE USB SAND DOLLAR | 01-SAND60US | Silver | 3 | 3 | 4 | 1 | 0.2 | \$ 260 |
|                        | 01-SAND60UW | White  |   |   |   |   |     | \$ 260 |
|                        | 01-SAND60UB | Black  |   |   |   |   |     | \$ 260 |

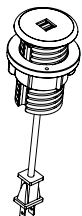

#### Description

- Mounts in 2 $\frac{3}{8}$ " (60mm) Round Grommet
- Dual USB Outlets with 6' Cord

|                     |              |        |                   |   |   |   |     |        |
|---------------------|--------------|--------|-------------------|---|---|---|-----|--------|
| DUO CLAMP NEMA PLUG | 01-DUOCLAMPS | Silver | 5 $\frac{1}{2}$ " | 3 | 7 | 1 | 0.2 | \$ 537 |
|                     | 01-DUOCLAMPW | White  |                   |   |   |   |     | \$ 537 |
|                     | 01-DUOCLAMPB | Black  |                   |   |   |   |     | \$ 537 |

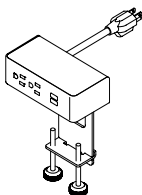

#### Description

- Standard with: Two (2) Power Outlet, Two (2) USB Ports, 10' Cord
- Clamps to Top and Features Silver Metal Trim
- Independent USB Circuit Controllers Deliver up to 2.1 Amps to Each Post
- All Mounting Hardware Included
- FCC Part 15A and UL Approved for Horizontal and Vertical Applications

| Item                  | Model No.      |          | Width | Depth           | Height          | Ship Wt | Cubic Ft | List Price |
|-----------------------|----------------|----------|-------|-----------------|-----------------|---------|----------|------------|
| INTERACT POWER & DATA | 01-INTERACTG2A | Aluminum | 9     | 5 $\frac{5}{8}$ | 2 $\frac{3}{4}$ | 5       | 0.2      | \$ 836     |
|                       | 01-INTERACTG2B | Black    |       |                 |                 |         |          | \$ 836     |



**Description**

- Includes: Two (2) Power Outlets, Two (2) USB-A Charging Ports, One (1) Telecom Plate Opening; Two (2) Keystone Openings for Voice/Data Jacks
- One (1) Telecom Plates Included with the Unit: One (1) 01-ABLAB Plate (Consists of One (1) RJ45 Cat 6, One (1) RJ11 Cat 3 Phone Jack)
- Convenience Plug on Bottom
- 6' Power Cord
- UL and CSA Recognized
- Additional Telecom Plates, See Page 43

|                          |             |          |                  |                 |                 |    |     |         |
|--------------------------|-------------|----------|------------------|-----------------|-----------------|----|-----|---------|
| WORKSURFACE POWER CENTER | 01-INTRFC1A | Aluminum | 14 $\frac{1}{4}$ | 6 $\frac{3}{8}$ | 2 $\frac{7}{8}$ | 11 | 0.3 | \$ 1936 |
|                          | 01-INTRFC1B | Black    |                  |                 |                 |    |     | \$ 1936 |



**Description**

- For Use with Conference Tables
- Four (4) Power Outlets, Three (3) Telecom Plate Openings
- Two (2) Telecom Plates Included with the Unit: One (1) 01-ABLAB Plate (Consists of One (1) RJ45 Cat 6, One (1) RJ11 Cat 3 Phone Jack); One (1) 01-ABLBB Plate (Consists of Two (2) RJ45 Cat 6)
- 6' Power Cord
- Convenience Plug on Bottom
- UL Listed/CSA Certified
- Additional Telecom Plates, See Arlington Tables in the Table and Space Division Price List

|                         |          |  |    |                 |               |   |   |        |
|-------------------------|----------|--|----|-----------------|---------------|---|---|--------|
| WIRE MANAGEMENT CHANNEL | 01-WMGR4 |  | 16 | 1 $\frac{1}{2}$ | $\frac{3}{4}$ | 1 | - | \$ 109 |
|-------------------------|----------|--|----|-----------------|---------------|---|---|--------|

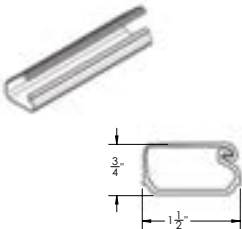

**Description**

- Set of Four (4) Black Plastic Wire Management Channels
- Snap Lock Channel
- Attaches with Adhesive Strips
- Ships via UPS Only

|            |           |  |                 |                 |   |   |   |       |
|------------|-----------|--|-----------------|-----------------|---|---|---|-------|
| CABLE GRIP | 01-WMGRCB |  | 5 $\frac{3}{8}$ | 2 $\frac{5}{8}$ | - | - | - | \$ 16 |
|------------|-----------|--|-----------------|-----------------|---|---|---|-------|

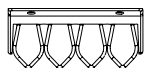

**Description**

- Under Surface Wire Management
- Black

[See Arlington Overview For Ordering Options](#)

| Item               | Model No.     | Description  | List Price |
|--------------------|---------------|--|------------|
| ECA TELECOM PLATES | 01-ABL        | Telecom Plate, Blank Plate   | \$ 39      |
|                    | 01-ABL737373  | Telecom Plate, Three (3) RJ45 Cat 5e   | \$ 345     |
|                    | 01-ABLAB      | Telecom Plate, One (1) RJ45 Cat 6, One (1) RJ11 Cat 3 Phone  | \$ 193     |
|                    | 01-ABLAB102   | Telecom Plate, One (1) RJ45 Cat 6, One (1) RJ11 Cat 3, One (1) USB W/72" Patch Cord                              | \$ 300     |
|                    | 01-ABLABB     | Telecom Plate, Two (2) RJ45 Cat 6, One (1) RJ11 Cat 3 Phone  | \$ 300     |
|                    | 01-ABLB       | Telecom Plate, One (1) RJ45 Cat 6  | \$ 140     |
|                    | 01-ABLBB      | Telecom Plate, Two (2) RJ45 Cat 6  | \$ 244     |
|                    | 01-ABLBBB     | Telecom Plate, Three (3) RJ45 Cat 6  | \$ 345     |
|                    | 01-ABLBBBB    | Telecom Plate, (4) RJ45 Cat 6  | \$ 447     |
|                    | 01-ABLBBC51   | Telecom Plate, Two (2) RJ45 Cat 6, One (1) 15 Pin HD VGA w/72" Patch Cord  | \$ 418     |
|                    | 01-ABLBC51L   | Telecom Plate, One (1) RJ45 Cat 6, One (1) Mini Stereo Inline, One (1) 15 Pin HD VGA w/72" Patch Cord            | \$ 384     |
|                    | 01-ABLC3811   | Telecom Plate, One (1) RJ45 Cat 6 Data Inline, One (1) RJ11 Cat 3 Phone Inline                                   | \$ 184     |
|                    | 01-ABLC45     | Telecom Plate, One (1) HDMI w/36" Patch Cord   | \$ 277     |
|                    | 01-ABLC45C51L | Telecom Plate, One (1) Mini Stereo Inline, One (1) HDMI w/36" Patch Cord, One (1) 15 Pin HD VGA w/72" Patch Cord | \$ 523     |
|                    | 01-ABLC51L    | Telecom Plate, One (1) 15 Pin HD VGA & One (1) Mini Stereo Inline Jack   | \$ 280     |
|                    | 01-ABLCRDM    | Telecom Plate, Three (3) Cord Bushings   | \$ 90      |

Compatible with:



Interact Power & Data  
01-INTERACTG2A, 01-INTERACTG2B



Power Center  
01-INTRFCIA, 01-INTRFCIB



Contemporary components complement our Madera and Allegiance casegoods collections, along with Aura Reception. Add technology function with wall units that include AV cabinets and valance with optional pull down projection screen. For easy table-to-floor connectivity, combine a table top power center with a cylinder or canoe base with hinged wire access door. Aura is also available in a Premium Veneer Option.

### CONSTRUCTION

*Aura Tables and Components feature your choice of either a Veneer or HPL top, Veneer and Metal bases, and Veneer chassis (where applicable).*

### VENEERS

- Choose from premium veneer or select veneer on exposed surfaces in Cherry, Maple, White Oak or American Black Walnut, carefully selected and matched to assure proper balance and consistency

### LAMINATES

- Exposed surfaces are produced from wood grained laminates fused to a particle-board core
- Each laminate offers lasting beauty, superior resistance to normal wear, and easy maintenance

### TOPS

- Wood Veneer worksurfaces are 5-ply balanced construction, while High Pressure Laminate (HPL) worksurfaces are 3-ply balanced construction, 1 $\frac{1}{16}$ " thick with solid hardwood rims
- All buffets, credenzas, serving carts, video cabinets, and storage/wardrobe cabinets are shaped on the user side only
- Grain direction runs left to right, unless otherwise noted

### CHASSIS

- Tops and end panels are securely fastened using high quality European fastening systems to ensure maximum strength
- All units ship with heavy-duty, adjustable leveling glides to ensure proper leveling and compensation for uneven floors

### DRAWERS

- All drawer fronts are standard with elegant vertically matched veneer faces
- Drawers feature 5-sided construction with  $\frac{3}{4}$ " 3-ply fronts,  $\frac{7}{16}$ " thick hardwood sides and  $\frac{5}{32}$ " hardboard bottoms
- Units with 36" wide file drawers feature  $\frac{1}{4}$ " thick drawer bottoms for maximum storage strength
- Drawer interiors are sanded, sealed, and finished to provide for a smooth, quality feel and appearance.
- All drawers feature full extension, progressive action slides with precision steel ball bearings
- Box and file drawers are tested for 100lb capacity
- Lateral files are tested for 200lb capacity
- All suspensions have a limited lifetime warranty

### STORAGE

- All hinged doors include soft close hinges, unless otherwise noted
- One piece hinge and base plate combination
- Soft close hinges reduce stress placed on the cabinet when the door is closed and offers a quiet closure

### LOCKING

- All units with file drawers feature locking
- Removable lock cylinders allow for units to be re-keyed at a later date, if required
- Units are shipped randomly keyed as standard
- Keyed alike units are available upon request at no additional charge
- Lock core will match pull color

### INTERIOR DRAWER DIMENSIONS

#### Models

92-2472BFD 92-2436SV

#### Drawers

|     | W                    | L                  | D                   |
|-----|----------------------|--------------------|---------------------|
| Box | 14 $\frac{17}{32}$ " | 19 $\frac{1}{4}$ " | 3 $\frac{21}{32}$ " |

#### Models

92-2436BF 92-2472BF

#### Drawers

|     | W                   | L                  | D                   |
|-----|---------------------|--------------------|---------------------|
| Box | 32 $\frac{9}{16}$ " | 19 $\frac{1}{4}$ " | 3 $\frac{21}{32}$ " |

#### Models

92-2472SBF

#### Drawers

|     | W                    | L                  | D                   |
|-----|----------------------|--------------------|---------------------|
| Box | 14 $\frac{17}{32}$ " | 19 $\frac{1}{4}$ " | 3 $\frac{21}{32}$ " |
| Box | 32 $\frac{9}{16}$ "  | 19 $\frac{1}{4}$ " | 3 $\frac{21}{32}$ " |

### HOW TO ORDER EXAMPLES

|                      | QTY | MODEL NO.   | DESCRIPTION                 | EXAMPLE |
|----------------------|-----|-------------|-----------------------------|---------|
| <b>TOP</b>           | 1   | 92-4296RT   | Premium or Standard Veneer  | PV      |
|                      |     |             | Top Material                | W       |
|                      |     |             | Finish/Color                | AW      |
|                      |     |             | Edge Profile                | Y       |
|                      |     |             | Grommet/Power/Data Location | ELR     |
| <b>BASES</b>         | 2   | 01-2020CB   | Premium or Standard Veneer  | PV      |
|                      |     |             | Finish                      | AW      |
|                      |     |             | Grommet Option              | GCBIS   |
| <b>PORTS</b>         | 1   | 01-INTRFC1A |                             |         |
| <b>TELECOM PLATE</b> | 1   | 01-ABLABB   |                             |         |
| <b>BUFFET</b>        | 1   | 92-2472BFD  | Premium or Standard Veneer  | PV      |
|                      |     |             | Top Material                | W       |
|                      |     |             | Finish/Color                | AW      |
|                      |     |             | Edge Profile                | Y       |
|                      |     |             | Pull                        | AOR     |

### PREMIUM VENEER (PV) AND VENEER (W) OPTIONS

Veneer features UVAdvantage, an ultra-violet finish, on all exposed surfaces by utilizing roll-coat UV technology

|     |                    |     |                     |
|-----|--------------------|-----|---------------------|
| AW  | Artisan Walnut     | HW  | Harvest Walnut      |
| CO  | Columbian Walnut   | LW  | Legacy Walnut       |
| DC  | Dark Cherry        | MW  | Mahogany Walnut     |
| DFW | Dark Forest Walnut | MO  | Medium Oak*         |
| EW  | Espresso           | SCH | Select Cherry       |
| FO  | Fawn Oak*          | SKC | Shaker Cherry       |
| GC  | Golden Cherry      | SM  | Sugar Maple         |
| HVM | Harvest Maple      | WC  | Williamsburg Cherry |

\*Finish is Low Sheen

### HPL (P) LAMINATE OPTIONS

#### WOODGRAIN

|     |                  |     |                     |
|-----|------------------|-----|---------------------|
| CO  | Columbian Walnut | SM  | Sugar Maple         |
| EF  | Espresso         | SCH | Select Cherry       |
| GC  | Golden Cherry    | SKC | Shaker Cherry       |
| HVM | Harvest Maple    | WC  | Williamsburg Cherry |
| MW  | Mahogany Walnut  |     |                     |

### HPL (P) LAMINATE OPTIONS FOR RECTANGULAR BOX BASE ONLY

#### WOODGRAIN

|     |                  |     |                     |
|-----|------------------|-----|---------------------|
| AS  | Asian Night      | PNW | Pinnacle Walnut     |
| BW  | Beigewood        | SCH | Select Cherry       |
| CO  | Columbian Walnut | SKC | Shaker Cherry       |
| EF  | Espresso         | SBP | Smoky Brown Pear    |
| GC  | Golden Cherry    | TK  | Studio Teak         |
| HVM | Harvest Maple    | SM  | Sugar Maple         |
| MW  | Mahogany Walnut  | WTA | Weathered Ash       |
| ORW | Oak Riftwood     | WC  | Williamsburg Cherry |

#### SOLID

|     |                |     |            |
|-----|----------------|-----|------------|
| BL  | Black          | PPD | Pepperdust |
| WH  | Designer White | SG  | Slate Grey |
| FHG | Fashion Grey   | WHS | White Sand |

### EDGE PROFILES

|   |          |   |         |   |           |
|---|----------|---|---------|---|-----------|
| B | Bevel    | O | Phoenix | Z | Tail      |
| D | Bullnose | A | Radius  | E | Tri-Round |
| X | Flute    | Y | Square  | N | Waterfall |



Bevel (B)



Bullnose (D)



Flute (X)



Phoenix (O)



Radius (A)



Square (Y)



Tail (Z)



Tri-Round (E)



Waterfall (N)

### METAL FINISH OPTIONS

|      |          |      |              |
|------|----------|------|--------------|
| ALUM | Aluminum | OYST | Oyster White |
| MIST | Mist     | SUGC | Sugar Cookie |
| NOIR | Noir     |      |              |

### GROMMET/POWER/DATA OPTIONS & LOCATIONS

See units and options in [accessories section](#) and the [general power and locations information section](#)

### PULL OPTIONS

Note: Lock Core will match Pull Color

|     |                   |     |                  |
|-----|-------------------|-----|------------------|
| AAV | Alcove, Aluminum  | AEL | Elite, Aluminum  |
| CAV | Alcove, Chrome    | BEL | Elite, Black     |
| AAC | Arc, Aluminum     | AFL | Flair, Aluminum  |
| BAC | Arc, Black        | CFL | Flair, Chrome    |
| ABM | Beam, Aluminum    | AFC | Focus, Aluminum  |
| BBM | Beam, Black       | BFC | Focus, Black     |
| ABT | Bow Tie, Aluminum | AQD | Quadra, Aluminum |
| NBT | Bow Tie, Nickel   | BQD | Quadra, Black    |
| ABU | Buckle, Aluminum  |     |                  |
| BBU | Buckle, Black     |     |                  |



### LOCKING DOORS

Locking doors are available on specific units, where noted. You must specify WITH LOCKING when ordering and add upcharge.

|        |                     |    |     |
|--------|---------------------|----|-----|
| LKT_HU | 72" W - 48" W Units | \$ | 108 |
| LKT_HU | 42" W - 24" W Units | \$ | 85  |
| LKT_HU | 18" W Units         | \$ | 65  |

### CERTIFICATIONS & COMPLIANCE

- Intertek Sustainability Certified
- BIFMA level® Certified
- BIFMA Compliant Certified
- TSCA Title VI (formerly CARB) Compliance
- US Green Building's LEED Contribution



**Tops/Shapes**

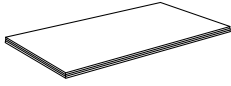

Rectangular [\(See Details\)](#)



Arc Rectangular [\(See Details\)](#)



Racetrack [\(See Details\)](#)

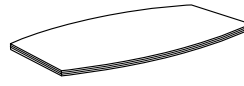

Boat-Shaped [\(See Details\)](#)

**Bases**

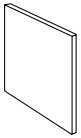

Rectangular Panel [\(See Details\)](#)

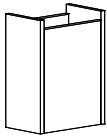

Rectangular with Door [\(See Details\)](#)

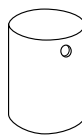

Cylinder [\(See Details\)](#)

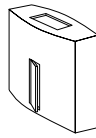

Canoe [\(See Details\)](#)

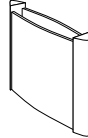

V-Capped Panel [\(See Details\)](#)

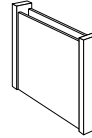

Flat-Capped Panel [\(See Details\)](#)



Metal [\(See Details\)](#)



Strut [\(See Details\)](#)

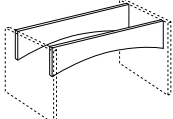

Arch Stretcher Rails [\(See Details\)](#)

**Storage Components**

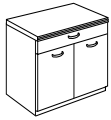

Two Door Buffet w/Drawer [\(See Details\)](#)

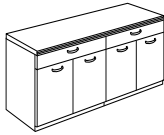

Four Door Buffet w/2 Drawers [\(See Details\)](#)

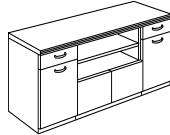

Four Door Buffet w/2 Drawers & Open Storage [\(See Details\)](#)

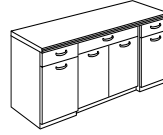

Four Door Buffet w/3 Drawers [\(See Details\)](#)

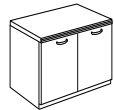

Two Door Credenza [\(See Details\)](#)

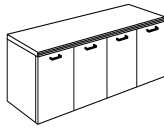

Four Door Credenza [\(See Details\)](#)

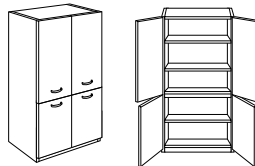

Storage Cabinet Double Doors [\(See Details\)](#)

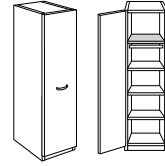

Wardrobe/Storage Cabinet [\(See Details\)](#)



Mobile Serving Cart [\(See Details\)](#)

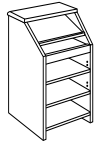

Lectern Stand [\(See Details\)](#)

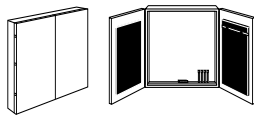

Visual Board [\(See Details\)](#)

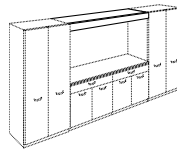

Visor Rail [\(See Details\)](#)

**Wire Management & Power/Data Accessories**

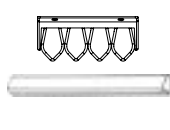
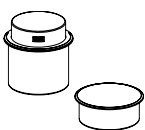

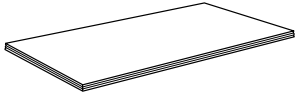
| Item   | Model No.                         | W   | D  | H      | Ship Wt | Cubic Ft | List Price                         |
|--|-----------------------------------|-----|----|--------|---------|----------|------------------------------------|
| <b>RECTANGULAR TOPS</b><br> | <b>192" or 16' - 2 Piece Tops</b> |     |    |        |         |          |                                    |
|  | 92-48192RT                        | 192 | 48 | 1 1/16 | 375     | 15.5     | P\$ 7526<br>W\$ 9411<br>PV\$ 11011 |
|  | <b>168" or 14' - 2 Piece Tops</b> |     |    |        |         |          |                                    |
|  | 92-48168RT                        | 168 | 48 | 1 1/16 | 325     | 13.6     | P\$ 7423<br>W\$ 8785<br>PV\$ 10278 |
|  | <b>144" or 12' - 2 Piece Tops</b> |     |    |        |         |          |                                    |
|  | 92-48144RT                        | 144 | 48 | 1 1/16 | 275     | 12.3     | P\$ 6273<br>W\$ 7317<br>PV\$ 8560  |
|  | <b>120" or 10' - 2 Piece Tops</b> |     |    |        |         |          |                                    |
|  | 92-48120RT                        | 120 | 48 | 1 1/16 | 225     | 10.3     | P\$ 5645<br>W\$ 6483<br>PV\$ 7584  |
|  | <b>96" or 8' - 1 Piece Top</b>    |     |    |        |         |          |                                    |
|  | 92-4296RT                         | 96  | 42 | 1 1/16 | 180     | 9.4      | P\$ 4286<br>W\$ 4914<br>PV\$ 5752  |
|  | <b>72" or 6' - 1 Piece Top</b>    |     |    |        |         |          |                                    |
|  | 92-3672RT                         | 72  | 36 | 1 3/16 | 100     | 6.2      | P\$ 2866<br>W\$ 3345<br>PV\$ 3913  |

Must Specify (in this order):

Model #  
 Top Material  
 Finish/Color  
 Edge Profile  
 Grommet/Power/Data Location

**Description**

- Grain Runs the Width of the Table
- Heavy-Duty Ganging Mechanisms Connect Two (2) Piece Tops
- See Bases/Legs and Number Required For Each Top Size, [See Multiple Base Options](#); Must Order Separately
- When Using with Strut Legs, We Recommend Using Two (2) Stiffener Bars on Tops 96"W and Four (4) Stiffener Bars on Tops 144"W and Wider; Must Order Separately, [See Strut Legs Details](#)
- Tops 120"W Do Not Need Stretcher Rails When Used with Strut Legs, the Location and Number of Strut Legs Required Offer Sufficient Support
- Optional Grommets and Power/Data; For Locations See the [General Power and Locations Information section](#), See Units and Unit Options in [Accessories Section](#)

PV = Premium Veneer W = Veneer P = HPL

[See Aura Overview For Ordering Options](#)

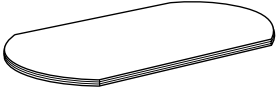
| Item  | Model No.                         | W   | D                | H                | Ship Wt | Cubic Ft | List Price |       |
|---|-----------------------------------|-----|------------------|------------------|---------|----------|------------|-------|
| <b>ARC RECTANGULAR TOPS</b><br><br><br><br>Must Specify (in this order):<br>Model #<br>Top Material<br>Finish/Color<br>Edge Profile<br>Grommet/Power/Data Location | <b>192" or 16' - 2 Piece Tops</b> |     |                  |                  |         |          |            |       |
|   | 92-48192AR                        | 192 | 48               | 1 $\frac{3}{16}$ | 375     | 15.5     | P\$        | 8999  |
|   |                                   |     |                  |                  |         |          | W\$        | 10456 |
|   |                                   |     |                  |                  |         |          | PV\$       | 12234 |
|   | <b>168" or 14' - 2 Piece Tops</b> |     |                  |                  |         |          |            |       |
|   | 92-48168AR                        | 168 | 48               | 1 $\frac{3}{16}$ | 325     | 13.6     | P\$        | 8574  |
|   |                                   |     |                  |                  |         |          | W\$        | 9929  |
|   |                                   |     |                  |                  |         |          | PV\$       | 11618 |
|   | <b>144" or 12' - 2 Piece Tops</b> |     |                  |                  |         |          |            |       |
|   | 92-48144AR                        | 144 | 48               | 1 $\frac{3}{16}$ | 275     | 12.3     | P\$        | 7214  |
|   |                                   |     |                  |                  |         |          | W\$        | 8260  |
|   |                                   |     |                  |                  |         |          | PV\$       | 9666  |
|   | <b>120" or 10' - 2 Piece Tops</b> |     |                  |                  |         |          |            |       |
|   | 92-48120AR                        | 120 | 48               | 1 $\frac{3}{16}$ | 225     | 10.3     | P\$        | 6794  |
|   |                                   |     |                  |                  |         |          | W\$        | 7633  |
|   |                                   |     |                  |                  |         |          | PV\$       | 8927  |
|   | <b>96" or 8' - 1 Piece Top</b>    |     |                  |                  |         |          |            |       |
|   | 92-4296AR                         | 96  | 42               | 1 $\frac{3}{16}$ | 180     | 9.4      | P\$        | 5123  |
|   |                                   |     |                  |                  |         | W\$      | 5752       |       |
|   |                                   |     |                  |                  |         | PV\$     | 6726       |       |
| <b>72" or 6' - 1 Piece Top</b>  |                                   |     |                  |                  |         |          |            |       |
| 92-3672AR   | 72                                | 36  | 1 $\frac{3}{16}$ | 100              | 6.2     | P\$      | 3345       |       |
|   |                                   |     |                  |                  |         | W\$      | 3826       |       |
|   |                                   |     |                  |                  |         | PV\$     | 4476       |       |

#### Description

- Grain Runs the Width of the Table
- Heavy-Duty Ganging Mechanisms Connect Two (2) Piece Tops
- See Bases/Legs and Number Required For Each Top Size, [See Multiple Base Options](#); Must Order Separately
- When Using with Strut Legs, We Recommend Using Two (2) Stiffener Bars on Tops 96"W and Four (4) Stiffener Bars on Tops 144"W and Wider; Must Order Separately, [See Strut Legs Details](#)
- Tops 120"W Do Not Need Stretcher Rails When Used with Strut Legs, the Location and Number of Strut Legs Required Offer Sufficient Support
- Optional Grommets and Power/Data; For Locations See the [General Power and Locations Information section](#), See Units and Unit Options in [Accessories Section](#)

PV = Premium Veneer W = Veneer P = HPL

[See Aura Overview For Ordering Options](#)

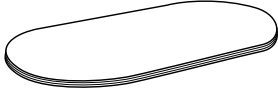
| Item   | Model No.                         | W   | D  | H                | Ship Wt | Cubic Ft | List Price                          |
|--|-----------------------------------|-----|----|------------------|---------|----------|-------------------------------------|
| <b>RACETRACK TOPS</b><br> | <b>192" or 16' - 2 Piece Tops</b> |     |    |                  |         |          |                                     |
|  | 92-48192AT                        | 192 | 48 | 1 $\frac{3}{16}$ | 375     | 15.5     | P\$ 9827<br>W\$ 11712<br>PV\$ 13705 |
|  | <b>168" or 14' - 2 Piece Tops</b> |     |    |                  |         |          |                                     |
|  | 92-48168AT                        | 168 | 48 | 1 $\frac{3}{16}$ | 325     | 13.6     | P\$ 9618<br>W\$ 10982<br>PV\$ 12848 |
|  | <b>144" or 12' - 2 Piece Tops</b> |     |    |                  |         |          |                                     |
|  | 92-48144AT                        | 144 | 48 | 1 $\frac{3}{16}$ | 275     | 12.3     | P\$ 8158<br>W\$ 9201<br>PV\$ 10765  |
|  | <b>120" or 10' - 2 Piece Tops</b> |     |    |                  |         |          |                                     |
|  | 92-48120AT                        | 120 | 48 | 1 $\frac{3}{16}$ | 225     | 10.3     | P\$ 7526<br>W\$ 8363<br>PV\$ 9785   |
|  | <b>96" or 8' - 1 Piece Top</b>    |     |    |                  |         |          |                                     |
|  | 92-4296AT                         | 96  | 42 | 1 $\frac{3}{16}$ | 180     | 9.4      | P\$ 5437<br>W\$ 6067<br>PV\$ 7097   |
|  | <b>72" or 6' - 1 Piece Top</b>    |     |    |                  |         |          |                                     |
|  | 92-3672AT                         | 72  | 36 | 1 $\frac{3}{16}$ | 100     | 6.2      | P\$ 3908<br>W\$ 4390<br>PV\$ 5137   |

Must Specify (in this order):

Model #  
 Top Material  
 Finish/Color  
 Edge Profile  
 Grommet/Power/Data Location

**Description**

- Grain Runs the Width of the Table
- Heavy Duty Ganging Mechanisms Connect Two (2) Piece Tops
- See Bases/Legs and Number Required For Each Top Size, [See Multiple Base Options](#); Must Order Separately
- When Using with Strut Legs, We Recommend Using Two (2) Stiffener Bars on Tops 96"W and Four (4) Stiffener Bars on Tops 144"W and Wider; Must Order Separately, [See Strut Legs Details](#)
- Tops 120"W Do Not Need Stretcher Rails When Used with Strut Legs, the Location and Number of Strut Legs Required Offer Sufficient Support
- Optional Grommets and Power/Data; For Locations See the [General Power and Locations Information section](#), See Units and Unit Options in [Accessories Section](#)

PV = Premium Veneer W = Veneer P = HPL

[See Aura Overview For Ordering Options](#)

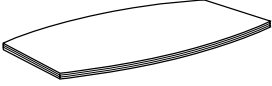
| Item   | Model No.                         | W   | D                | H                | Ship Wt | Cubic Ft | List Price |       |
|--|-----------------------------------|-----|------------------|------------------|---------|----------|------------|-------|
| <b>BOAT-SHAPED TOPS</b><br> | <b>192" or 16' - 2 Piece Tops</b> |     |                  |                  |         |          |            |       |
|  | 92-48192BT                        | 192 | 48               | 1 $\frac{1}{16}$ | 375     | 15.5     | P\$        | 9827  |
|  |                                   |     |                  |                  |         |          | W\$        | 11712 |
|  |                                   |     |                  |                  |         |          | PV\$       | 13705 |
|  | <b>168" or 14' - 2 Piece Tops</b> |     |                  |                  |         |          |            |       |
|  | 92-48168BT                        | 168 | 48               | 1 $\frac{1}{16}$ | 325     | 13.6     | P\$        | 9618  |
|  |                                   |     |                  |                  |         |          | W\$        | 10982 |
|  |                                   |     |                  |                  |         |          | PV\$       | 12848 |
|  | <b>144" or 12' - 2 Piece Tops</b> |     |                  |                  |         |          |            |       |
|  | 92-48144BT                        | 144 | 48               | 1 $\frac{1}{16}$ | 275     | 12.3     | P\$        | 8158  |
|  |                                   |     |                  |                  |         |          | W\$        | 9201  |
|  |                                   |     |                  |                  |         |          | PV\$       | 10765 |
|  | <b>120" or 10' - 2 Piece Tops</b> |     |                  |                  |         |          |            |       |
|  | 92-48120BT                        | 120 | 48               | 1 $\frac{1}{16}$ | 225     | 10.3     | P\$        | 7526  |
|  |                                   |     |                  |                  |         |          | W\$        | 8363  |
|  |                                   |     |                  |                  |         | PV\$     | 9785       |       |
| <b>96" or 8' - 1 Piece Top</b>   |                                   |     |                  |                  |         |          |            |       |
| 92-4296BT  | 96                                | 42  | 1 $\frac{1}{16}$ | 180              | 9.4     | P\$      | 5437       |       |
|  |                                   |     |                  |                  |         | W\$      | 6067       |       |
|  |                                   |     |                  |                  |         | PV\$     | 7097       |       |
| <b>72" or 6' - 1 Piece Top</b>   |                                   |     |                  |                  |         |          |            |       |
| 92-3672BT  | 72                                | 36  | 1 $\frac{1}{16}$ | 100              | 6.2     | P\$      | 3908       |       |
|  |                                   |     |                  |                  |         | W\$      | 4390       |       |
|  |                                   |     |                  |                  |         | PV\$     | 5137       |       |

**Must Specify (in this order):**

Model #  
 Top Material  
 Finish/Color  
 Edge Profile  
 Grommet/Power/Data Location

**Description**

- Grain Runs the Width of the Table
- Heavy Duty Ganging Mechanisms Connect 2 Piece Tops
- See Bases/Legs and Number Required For Each Top Size, [See Multiple Base Options](#); Must Order Separately
- When Using with Strut Legs, We Recommend Using Two (2) Stiffener Bars on Tops 96"W and Four (4) Stiffener Bars on Tops 144"W and Wider; Must Order Separately, [See Strut Legs Details](#)
- Tops 120"W Do Not Need Stretcher Rails When Used with Strut Legs, the Location and Number of Strut Legs Required Offer Sufficient Support
- Optional Grommets and Power/Data; For Locations See the [General Power and Locations Information section](#), See Units and Unit Options in [Accessories Section](#)

PV = Premium Veneer W = Veneer P = HPL

[See Aura Overview For Ordering Options](#)

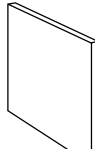
| Item   | Model No.                      | W  | D | H   | Ship Wt | Cubic Ft | List Price            |
|--|--------------------------------|----|---|-----|---------|----------|-----------------------|
| <b>RECTANGULAR PANEL BASE</b><br> | <b>For Tables 48"D</b>         |    |   |     |         |          |                       |
|  | 01-2428RBV                     | 24 | 2 | 28½ | 34      | 2.7      | W\$ 1023<br>PV\$ 1197 |
|  | <b>For Tables 36"D to 42"D</b> |    |   |     |         |          |                       |
|  | 01-2028RBV                     | 20 | 2 | 28½ | 28      | 2.3      | W\$ 957<br>PV\$ 1121  |

Must Specify (in this order):

- Model # and Quantity
- Premium or Standard Veneer
- Finish
- Stretcher Rail

**Description**

- Stretcher Rails Included; Specify Model (See Below)
- Also available with Arch Stretcher Rails; Sold Separately
- See Number of Bases Required Per Table Width Below

| Table Widths                      | 72"      | 96"      | 120"      | 144"      | 168"      | 192"      |
|-----------------------------------|----------|----------|-----------|-----------|-----------|-----------|
| <b>Number of Bases Required</b>   | 2        | 2        | 3         | 3         | 3         | 5         |
| <b>Stretcher Rails (Included)</b> | 01-72STR | 01-96STR | 01-120STR | 01-144STR | 01-168STR | 01-192STR |

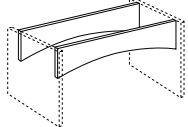
| Item   | Model No.   | W   | D | H      | Ship Wt | Cubic Ft | List Price            |
|--|-------------|-----|---|--------|---------|----------|-----------------------|
| <b>ARCH STRETCHER RAILS</b><br> | 01-192ARCHV | 192 | ¾ | 8 - 12 | 77      | 4.2      | W\$ 2426<br>PV\$ 2838 |
|  | 01-168ARCHV | 168 | ¾ | 8 - 12 | 68      | 4.2      | W\$ 1511<br>PV\$ 1771 |
|  | 01-144ARCHV | 144 | ¾ | 8 - 12 | 57      | 4.2      | W\$ 1382<br>PV\$ 1618 |
|  | 01-120ARCHV | 120 | ¾ | 8 - 12 | 46      | 4.2      | W\$ 1276<br>PV\$ 1492 |
|  | 01-96ARCHV  | 96  | ¾ | 8 - 12 | 35      | 4.2      | W\$ 864<br>PV\$ 1011  |
|  | 01-72ARCHV  | 72  | ¾ | 8 - 12 | 28      | 4.2      | W\$ 778<br>PV\$ 906   |

Must Specify (in this order):

- Model # and Quantity
- Premium or Standard Veneer
- Finish

**Description**

- For Use With Rectangular Bases; 01-2428RBV or 01-2028RBV
- Must Be Field Installed in Place of the Standard Stretcher Rails Shipped with Rectangular Bases
- Rails for Tables 120" to 168" will Ship as Two (2) Sets of Two (2)
- Rails for Tables 192" will Ship as Four (4) Sets of Two (2)

| Item   | Model No.   | W  | D  | H   | Ship Wt | Cubic Ft | List Price |
|--|-------------|----|----|-----|---------|----------|------------|
| <b>RECTANGULAR BOX BASE WITH DOOR</b><br> | 01-1220RBDV | 20 | 12 | 28½ | 50      | 5.4      | W\$ 825    |
|  |             |    |    |     |         |          | PV\$ 962   |
|  |             |    |    |     |         |          | C\$ 800    |
|  |             |    |    |     |         |          | CPV\$ 942  |

Must Specify (in this order):

- Model # and Quantity
- Premium or Standard Veneer
- Primary Finish/Color
- Accent Finish/Color

**Description**

- Rectangular Base with Lift-Off Removable Panel
- Available in Veneer, or a Combination of Veneer and Laminate; For Color Options [See Finish and Color Options](#)
- Must Indicate Accent Selection and Primary Selection on Order
- 2" Wire Management Access Across Both Sides
- Fully Open for Wire Management at the Bottom

| Table Widths                    | 72" | 96" | 120" | 144" | 168" | 192" |
|---------------------------------|-----|-----|------|------|------|------|
| <b>Number of Bases Required</b> | 2   | 2   | 3    | 3    | 3    | 3    |

PV = Premium Veneer W = Veneer C = Veneer and Laminate CPV = Premium Veneer and Laminate

[See Aura Overview For Ordering Options](#)

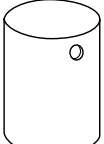
| Item  | Model No.                      | W  | D  | H   | Ship Wt | Cubic Ft | List Price            |
|---|--------------------------------|----|----|-----|---------|----------|-----------------------|
| <b>CYLINDER BASE</b><br><br> | <b>For Tables 42"D to 48"D</b> |    |    |     |         |          |                       |
|   | 01-2020CB                      | 20 | 20 | 28½ | 136     | 10.9     | W\$ 1456<br>PV\$ 1701 |
|   | <b>For Tables 36"D</b>         |    |    |     |         |          |                       |
|   | 01-1616CB                      | 16 | 16 | 28½ | 101     | 7.2      | W\$ 1331<br>PV\$ 1557 |

**Description**

- Veneer Cylinder Base Features Multi-Step, Hand-Finished Catalyzed Finish
- Weighted for Stability
- Two (2) Wire Management Black Grommets Standard at Top Edge; 8" Wire Management Opening Standard at Bottom
- See Number of Bases Required Per Table Width Below

**Additional Grommet Options: Specify & Add**

|       |                             |    |     |
|-------|-----------------------------|----|-----|
| GCBIS | One (1) Grommet At Top Edge | \$ | N/C |
| NOGC  | No Grommets At Top Edge     | \$ | N/C |

| Table Widths                    | 72" | 96" | 120" | 144" | 168" | 192" |
|---------------------------------|-----|-----|------|------|------|------|
| <b>Number of Bases Required</b> | 2   | 2   | 3    | 3    | 3    | 3    |

Must Specify (in this order):

- Model # and Quantity
- Premium or Standard Veneer
- Finish
- Grommet Options

|   |                  |    |    |     |    |     |                       |
|---|------------------|----|----|-----|----|-----|-----------------------|
| <b>CANOE BASE</b><br><br> | 01-1222CS        | 22 | 12 | 28½ | 27 | 5.8 | W\$ 3340<br>PV\$ 3907 |
|   | 01-1222CSD       | 22 | 12 | 28½ | 27 | 5.8 | W\$ 3876<br>PV\$ 4534 |
|   | <i>With Door</i> |    |    |     |    |     |                       |

**Description**

- Veneer Base Features Multi-Step, Hand-Finished Catalyzed Finish
- Two (2) Wire Management Black Grommets Standard at Top Edge; 6" Wire Management Opening in the Bottom
- Models with Doors Have a 18"H x 6"W Opening (Does Not Feature Soft Close Hinges)
- Adjustable Levelers

**Additional Grommet Options: Specify & Add**

|       |                             |    |     |
|-------|-----------------------------|----|-----|
| GCBIS | One (1) Grommet At Top Edge | \$ | N/C |
| NOGC  | No Grommets At Top Edge     | \$ | N/C |

| Table Widths                    | 72" | 96" | 120" | 144" | 168" | 192" |
|---------------------------------|-----|-----|------|------|------|------|
| <b>Number of Bases Required</b> | 2   | 2   | 3    | 3    | 3    | 3    |

Must Specify (in this order):

- Model # and Quantity
- Premium or Standard Veneer
- Finish
- Grommet Options

|   |             |     |   |     |    |     |                       |
|---|-------------|-----|---|-----|----|-----|-----------------------|
| <b>V-CAPPED PANEL BASE</b><br><br> | 01-0430VPBV | 30½ | 6 | 27¾ | 28 | 3.5 | W\$ 2031<br>PV\$ 2377 |
|---|-------------|-----|---|-----|----|-----|-----------------------|

**Description**

- Metal V-Cap Accents Veneer Panel Base
- Select From Five (5) Powdercoat Finishes; [See Metal Color Options](#)
- 3" Wire Access Across the Top
- Fully Open for Wire Management at the Bottom
- Adjustable Levelers

| Table Widths                    | 72" | 96" | 120" | 144" | 168" | 192" |
|---------------------------------|-----|-----|------|------|------|------|
| <b>Number of Bases Required</b> | 2   | 2   | 3    | 3    | 3    | 5    |

Must Specify (in this order):

- Model # and Quantity
- Premium or Standard Veneer
- Finish
- Metal Finish

PV = Premium Veneer W = Veneer

[See Aura Overview For Ordering Options](#)

| Item                   | Model No.   | W   | D | H   | Ship Wt | Cubic Ft | List Price            |
|------------------------|-------------|-----|---|-----|---------|----------|-----------------------|
| FLAT-CAPPED PANEL BASE | 01-0427FPBV | 27¾ | 4 | 27¾ | 31      | 3.5      | W\$ 2086<br>PV\$ 2436 |

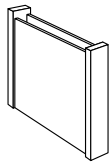

**Description**

- Metal Flat-Cap Accents Veneer Panel Base
- Select From (5) Powdercoat Finishes; [See Metal Color Options](#)
- 3" Wire Access Across the Top
- Fully Open for Wire Management at the Bottom
- Adjustable Levelers

Must Specify (in this order):

- Model # and Quantity
- Premium or Standard Veneer
- Finish
- Metal Finish

| Table Widths                    | 72" | 96" | 120" | 144" | 168" | 192" |
|---------------------------------|-----|-----|------|------|------|------|
| <b>Number of Bases Required</b> | 2   | 2   | 3    | 3    | 3    | 5    |

| METAL BASE | Model No.  | Color    | W  | D  | H   | Ship Wt | Cubic Ft | List Price |
|------------|------------|----------|----|----|-----|---------|----------|------------|
|            | 01-0400MBB | Black    | 32 | 32 | 27¾ | 32      | 3.2      | \$ 936     |
|            | 01-0400MBA | Aluminum | 32 | 32 | 27¾ | 32      | 3.2      | \$ 936     |



Open Market Only

**Description**

- Shipped KD; Some Assembly Required

Must Specify (in this order):

- Model # and Quantity

| Table Widths                    | 72" | 96" | 120" | 144" | 168" | 192" |
|---------------------------------|-----|-----|------|------|------|------|
| <b>Number of Bases Required</b> | 2   | 2   | 3    | 3    | 3    | 3    |

| STRUT TABLE LEGS | Model No.   | Quantity        | W  | D   | H   | Ship Wt | Cubic Ft | List Price |
|------------------|-------------|-----------------|----|-----|-----|---------|----------|------------|
|                  | 01-2228STR2 | 1 Pair (2 Legs) | 1½ | 22½ | 28⅞ | 32      | 4.5      | \$ 1199    |
|                  | 01-2228STR4 | 2 Pair (4 Legs) | 1½ | 22½ | 28⅞ | 64      | 9.0      | \$ 2398    |

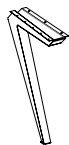

**Description**

- Available in Aluminum (ALUM) or Black (BLK); Must Specify Color
- Built-In Wire Management Cover on Inside of Legs
- Each Leg has Adjustable Glides
- Legs not Available To Be Sold Separately
- For Use with Indiana Furniture Tops Only

Must Specify (in this order):

- Model # and Quantity
- Color
- Stiffener Bar and Quantity

**Options: Specify & Add**

|                          |        |
|--------------------------|--------|
| 01-00048SB Stiffener Bar | \$ 234 |
|--------------------------|--------|

*See Individual Tops for Recommended Number of Stiffener Bars*

| Table Widths                    | 72" | 96" | 120" | 144" | 168"* | 192" |
|---------------------------------|-----|-----|------|------|-------|------|
| <b>Number of Bases Required</b> | 4   | 4   | 6    | 6    | 8     | 8    |

\*168" Racetrack Tops Require 6 Bases

PV = Premium Veneer W = Veneer

[See Aura Overview For Ordering Options](#)



| Item                               | Model No. | W  | D  | H  | Ship Wt | Cubic Ft | List Price                        |
|------------------------------------|-----------|----|----|----|---------|----------|-----------------------------------|
| <b>TWO DOOR BUFFET WITH DRAWER</b> | 92-2436BF | 36 | 24 | 36 | 189     | 21.7     | P\$ 4316<br>W\$ 4390<br>PV\$ 5137 |

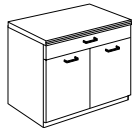

#### Description

- Top Edge Profiled on Approach Side Only ([See Edge Options](#)); Must Specify Edge Selection
- One (1) Drawer with Storage Behind Two (2) Doors and One (1) Adjustable Shelf

#### Must Specify (in this order):

Model #  
Premium or Standard Veneer  
Top Material  
Finish/Color  
Edge Profile  
Pull

|  |           |    |    |    |     |      |                                    |
|--|-----------|----|----|----|-----|------|------------------------------------|
| <b>FOUR DOOR BUFFET WITH TWO DRAWERS</b> | 92-2472BF | 72 | 24 | 36 | 342 | 45.6 | P\$ 8446<br>W\$ 8574<br>PV\$ 10030 |
|--|-----------|----|----|----|-----|------|------------------------------------|

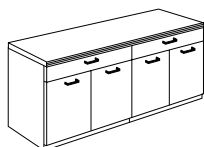

#### Description

- Top Edge Profiled on Approach Side Only ([See Edge Options](#)); Must Specify Edge Selection
- Two (2) Drawers with Storage Behind Four (4) Doors and Two (2) Adjustable Shelves

#### Must Specify (in this order):

Model #  
Premium or Standard Veneer  
Top Material  
Finish/Color  
Edge Profile  
Pull

|   |            |    |    |    |     |      |                                    |
|---|------------|----|----|----|-----|------|------------------------------------|
| <b>FOUR DOOR BUFFET WITH TWO DRAWERS AND OPEN STORAGE</b> | 92-2472BFD | 72 | 24 | 36 | 337 | 45.6 | P\$ 9387<br>W\$ 9515<br>PV\$ 11133 |
|---|------------|----|----|----|-----|------|------------------------------------|

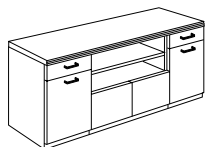

#### Description

- Top Edge Profiled on Approach Side Only ([See Edge Options](#)); Must Specify Edge Selection
- Two (2) Drawers with Open Storage and One (1) Adjustable Shelf
- Left and Right Storage Behind Doors with One (1) Adjustable Shelf
- Storage Behind Center Doors

#### Must Specify (in this order):

Model #  
Premium or Standard Veneer  
Top Material  
Finish/Color  
Edge Profile  
Pull

|  |            |    |    |    |     |      |                                    |
|--|------------|----|----|----|-----|------|------------------------------------|
| <b>FOUR DOOR BUFFET WITH THREE DRAWERS</b> | 92-2472SBF | 72 | 24 | 36 | 362 | 45.6 | P\$ 9387<br>W\$ 9515<br>PV\$ 11133 |
|--|------------|----|----|----|-----|------|------------------------------------|

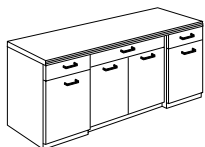

#### Description

- Top Edge Profiled on Approach Side Only ([See Edge Options](#)); Must Specify Edge Selection
- Three (3) Drawers with Storage Behind Four (4) Doors and Three (3) Adjustable Shelves
- Center Section is Stepped Back

#### Must Specify (in this order):

Model #  
Premium or Standard Veneer  
Top Material  
Finish/Color  
Edge Profile  
Pull

PV = Premium Veneer W = Veneer P = HPL

[See Aura Overview For Ordering Options](#)

| Item              | Model No. | W  | D  | H  | Ship Wt | Cubic Ft | List Price                        |
|-------------------|-----------|----|----|----|---------|----------|-----------------------------------|
| TWO DOOR CREDENZA | 92-2436CC | 36 | 24 | 30 | 150     | 17.6     | P\$ 3378<br>W\$ 3449<br>PV\$ 4037 |

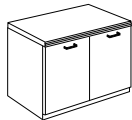

Must Specify (in this order):

Model #  
Premium or Standard Veneer  
Top Material  
Finish/Color  
Edge Profile  
Pull  
Locking Option

**Description**

- Top Edge Profiled on Approach Side Only ([See Edge Options](#)); Must Specify Edge Selection
- Two (2) Doors with One (1) Adjustable Shelf Behind Doors
- Additional Option: Locking Doors ([See Locking Door Options](#))

|                    |           |    |    |    |     |      |                                   |
|--------------------|-----------|----|----|----|-----|------|-----------------------------------|
| FOUR DOOR CREDENZA | 92-2472CC | 72 | 24 | 30 | 290 | 34.2 | P\$ 6669<br>W\$ 3449<br>PV\$ 4037 |
|--------------------|-----------|----|----|----|-----|------|-----------------------------------|

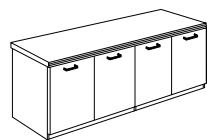

Must Specify (in this order):

Model #  
Premium or Standard Veneer  
Top Material  
Finish/Color  
Edge Profile  
Pull  
Locking Option

**Description**

- Top Edge Profiled on Approach Side Only ([See Edge Options](#)); Must Specify Edge Selection
- Four (4) Doors with Two (2) Adjustable Shelves Behind Doors
- Additional Option: Locking Doors ([See Locking Door Options](#))

|                             |            |    |    |                                  |     |      |                       |
|-----------------------------|------------|----|----|----------------------------------|-----|------|-----------------------|
| DOUBLE DOOR STORAGE CABINET | 92-3672SUD | 36 | 24 | 70 <sup>13</sup> / <sub>16</sub> | 285 | 42.0 | W\$ 7091<br>PV\$ 8299 |
|-----------------------------|------------|----|----|----------------------------------|-----|------|-----------------------|

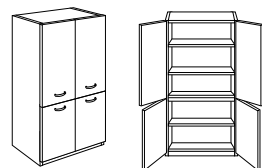

Must Specify (in this order):

Model #  
Premium or Standard Veneer  
Finish  
Edge Profile  
Pull

**Description**

- Top Section has Two (2) Adjustable Shelves; Bottom Section has One (1) Adjustable Shelf

| WARDROBE/STORAGE CABINET | HINGED LEFT | HINGED RIGHT | W  | D  | H                                | Ship Wt | Cubic Ft | List Price            |
|--------------------------|-------------|--------------|----|----|----------------------------------|---------|----------|-----------------------|
|                          | 92-1872WL   | 92-1872WR    | 18 | 24 | 70 <sup>13</sup> / <sub>16</sub> | 155     | 22.0     | W\$ 5123<br>PV\$ 5996 |

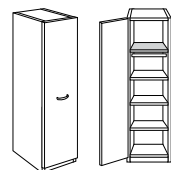

Shown as Left

Must Specify (in this order):

Model #  
Premium or Standard Veneer  
Finish  
Pull

**Description**

- Fixed Top Shelf; Coat Rod Under Fixed Shelf
- Three (3) Adjustable Shelves Behind Door
- Adjustable Shelves can be Removed for Wardrobe Application

PV = Premium Veneer W = Veneer P = HPL

[See Aura Overview For Ordering Options](#)

| Item       | Model No. | W  | D  | H                | Ship Wt | Cubic Ft | List Price            |
|------------|-----------|----|----|------------------|---------|----------|-----------------------|
| VISOR RAIL | 92-2472VR | 72 | 24 | 5 $\frac{3}{16}$ | 100     | 8.9      | W\$ 1362<br>PV\$ 1589 |

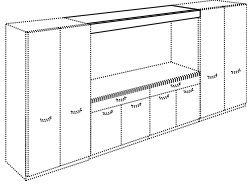

**Must Specify (in this order):**

Model #  
Premium or Standard Veneer  
Finish  
Projection Screen  
Task Light

**Description**

- Overhead Rail Creates Wall Unit
- For Use with 72" High Cabinets and Credenzas/Buffets (Ordered Separately)

**Options: Specify & Add**

|         |   |        |
|---------|---|--------|
| 1-PS    | Projection Screen (Requires Field Installation) | \$ 996 |
| TL-0848 | Task Light (Requires Field Installation)        | \$ 417 |

|              |           |    |    |    |     |      |                                   |
|--------------|-----------|----|----|----|-----|------|-----------------------------------|
| SERVING CART | 92-2436SV | 36 | 24 | 36 | 149 | 24.0 | P\$ 4898<br>W\$ 4966<br>PV\$ 5808 |
|--------------|-----------|----|----|----|-----|------|-----------------------------------|



**Must Specify (in this order):**

Model #  
Premium or Standard Veneer  
Top Material  
Finish/Color  
Edge Profile  
Pull  
Grommet Option

**Description**

- Top Edge Profiled on Approach Side Only ([See Edge Options](#)); Must Specify Edge Selection
- Two (2) Box Drawers with Storage Behind Two (2) Doors
- Open Storage
- Locking Casters

**Grommet Option: Specify & Add**

|        |   |       |
|--------|---|-------|
| 1-GRMT | Grommet in Back Panel; Must Specify Black or Silver | \$ 72 |
|--------|---|-------|

|               |           |    |    |    |     |      |                       |
|---------------|-----------|----|----|----|-----|------|-----------------------|
| LECTERN STAND | 92-2650LS | 26 | 24 | 50 | 130 | 21.9 | W\$ 4024<br>PV\$ 4706 |
|---------------|-----------|----|----|----|-----|------|-----------------------|

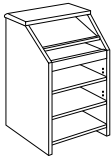

**Must Specify (in this order):**

Model #  
Premium or Standard Veneer  
Finish  
Edge Profile

**Description**

- Top Edge Profiled on Approach Side Only ([See Edge Options](#)); Must Specify Edge Selection
- Fixed Reading Shelf
- Pullout Shelf
- Two (2) Adjustable Storage Shelves in Lower Compartment
- Two (2) Locking and Two (2) Non-Locking Casters
- Wire Management Grommet in Bottom Shelf

|              |           |    |   |    |     |      |                       |
|--------------|-----------|----|---|----|-----|------|-----------------------|
| VISUAL BOARD | 92-4848VB | 48 | 5 | 48 | 150 | 11.0 | W\$ 4604<br>PV\$ 5329 |
|--------------|-----------|----|---|----|-----|------|-----------------------|

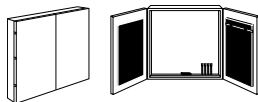

**Must Specify (in this order):**

Model #  
Premium or Standard Veneer  
Finish  
Project Screen  
Tackboard Fabric

**Description**

- Tackboard on Each Door Standard in Black Fabric Unless Specified; Price Valid for Grades 1, 2, & 3 (See Other Pricing Below)
- Display Rail with Adjustable Hooks for Flipchart
- Magnetic Porcelain Non-Glare Writing Surface
- Includes Flipchart, Set of Four (4) Dry Erase Markers and Eraser, Mounting Hardware
- Does Not Feature Soft Close Hinges

**Options: Specify & Add**

|                         | Grade 4   | Grade 5 | Grade 6 | Grade 7 | Grade 8 | Grade 9 | Grade 10 |
|-------------------------|---|---------|---------|---------|---------|---------|----------|
| Tackboard Fabric Change | \$ 260  | 382     | 506     | 382     | 866     | 1082    | 1328     |
| 1-PS                    | Projection Screen (Requires Field Installation) |         |         |         |         |         | \$ 996   |

PV = Premium Veneer W = Veneer P = HPL

[See Aura Overview For Ordering Options](#)

| Item                     | Model No.    | W  | D   | H  | Ship Wt | Cubic Ft | List Price |
|--------------------------|--------------|----|-----|----|---------|----------|------------|
| TABLE POWER & DATA VAULT | 01-CVAULTG2A | 4⅓ | 15⅞ | 4⅙ | 10      | 0.4      | \$ 1823    |



Open Market Only

**Description**

- Electric Drive Motor Rotates the Surface Technology 180° to the Proper Position
- Photo-Electronic Eye Prevents Rotation When Obstructed
- Two (2) Data Ports, Three (3) Power Outlets, and One (1) HDMI and Two (2) 5V USB
- 6' Power Cord
- UL and CSA Recognized

|                          |             |          |     |    |    |    |     |         |
|--------------------------|-------------|----------|-----|----|----|----|-----|---------|
| WORKSURFACE POWER CENTER | 01-INTRFC1A | Aluminum | 14¼ | 6⅝ | 2⅞ | 11 | 0.3 | \$ 1936 |
|                          | 01-INTRFC1B | Black    |     |    |    |    |     |         |

**Description**

- For Use with Conference Tables
- Four (4) Power Outlets, Three (3) Telecom Plate Openings
- Two (2) Telecom Plates Included with the Unit: One (1) 01-ABLAB Plate (Consists of One (1) RJ45 Cat 6, One (1) RJ11 Cat 3 Phone Jack); One (1) 01-ABLBB Plate (Consists of Two (2) RJ45 Cat 6)
- 6' Power Cord
- Convenience Plug on Bottom
- UL Listed/CSA Certified
- Additional Telecom Plates Available, [See Telecom Plate Options](#)

|                         |            |          |     |    |    |    |     |         |
|-------------------------|------------|----------|-----|----|----|----|-----|---------|
| OASIS MINI POWER & DATA | 01-OASISMA | Aluminum | 14¼ | 6⅝ | 2⅞ | 11 | 0.3 | \$ 2993 |
|                         | 01-OASISMB | Black    |     |    |    |    |     |         |

**Description**





- For Use with Conference Tables
- Soft Touch Hinged Lid
- Four (4) Power Outlets, Three (3) Telecom Plate Openings
- Two (2) Telecom Plates Included with the Unit: One (1) 01-ABLAB Plate (Consists of One (1) RJ45 Cat 6, One (1) RJ11 Cat 3 Phone Jack); One (1) 01-ABLB Plate (Consists of One (1) RJ45 Cat 6)
- 9' Power Cord
- UL Listed
- Additional Telecom Plates Available, [See Telecom Plate Options](#)

|                       |                |          |   |    |    |   |     |        |
|-----------------------|----------------|----------|---|----|----|---|-----|--------|
| INTERACT POWER & DATA | 01-INTERACTG2A | Aluminum | 9 | 5⅝ | 2¾ | 5 | 0.2 | \$ 836 |
|                       | 01-INTERACTG2B | Black    |   |    |    |   |     |        |

**Description**

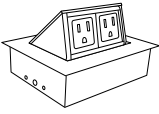
- Includes: Two (2) Power Outlets, Two (2) USB-A Charging Ports, One (1) Telecom Plate Opening; Two (2) Keystone Openings for Voice/Data Jacks
- One (1) Telecom Plates Included with the Unit: One (1) 01-ABLAB Plate (Consists of One (1) RJ45 Cat 6, One (1) RJ11 Cat 3 Phone Jack)
- Convenience Plug on Bottom
- 6' Power Cord
- UL and CSA Recognized
- Additional Telecom Plates Available, [See Telecom Plate Options](#)

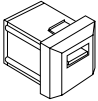
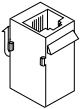
[See Aura Overview For Ordering Options](#)

| Item  | Model No.   |          | W                | D               | H | Ship Wt | Cubic Ft | List Price |
|---|---|----------|------------------|-----------------|---|---------|----------|------------|
| <b>POWER 440</b><br>       | 01-DATA440A   | Aluminum | 5 $\frac{5}{16}$ | 4 $\frac{3}{8}$ | - | 5       | 0.2      | \$ 904     |
|   | 01-DATA440B   | Black    |                  |                 |   |         |          |            |
|   | <b>Description</b>  |          |                  |                 |   |         |          |            |
|   | <ul style="list-style-type: none"> <li>• Two (2) Power Outlets</li> <li>• Soft Touch Hinged Lid</li> <li>• 6' Power Cord</li> <li>• UL and CSA Recognized</li> </ul>  |          |                  |                 |   |         |          |            |
| <b>POWER DATA PORT</b><br> | 01-DPORT4A  | Aluminum | 8                | 4               | - | 7       | 0.2      | \$ 1025    |
|   | 01-DPORT4B  | Black    |                  |                 |   |         |          |            |
|   | <b>Description</b>  |          |                  |                 |   |         |          |            |
|   | <ul style="list-style-type: none"> <li>• Retracts into Work Surface to Regain Productive Space; One-Touch Access to Power and Data</li> <li>• Two (2) Power Outlets and Two (2) Open Ports for Data</li> <li>• Additional Telecom Plates Available, <a href="#">See Telecom Plate Options</a></li> <li>• Water-Proof Simplex (Outlets)</li> <li>• Includes a Voice/Data Adapter Kit to Accept Couplers and Jacks When Required</li> <li>• 6' Power Cord</li> <li>• UL and CSA Recognized</li> </ul> |          |                  |                 |   |         |          |            |
| <b>USB PORT</b><br>      | 01-USBPORT  |          | -                | -               | - | -       | -        | \$ 151     |
|   | <b>Description</b>  |          |                  |                 |   |         |          |            |
|   | <ul style="list-style-type: none"> <li>• Increases Transfer Speed Up to 5 gbs/sec</li> <li>• Simultaneous Read/Write Capability; Idle Device Power Saving State</li> <li>• 6' Cord</li> <li>• Compatible with 01-DPORT4</li> </ul>  |          |                  |                 |   |         |          |            |
| <b>VOICE COUPLER</b><br> | 01-VOICE1   |          | -                | -               | - | -       | -        | \$ 69      |
|   | <b>Description</b>  |          |                  |                 |   |         |          |            |
|   | <ul style="list-style-type: none"> <li>• 6-Pin Modular Plug</li> <li>• Molded Black; Cord Not included</li> <li>• Compatible with 01-DPORT4</li> </ul>  |          |                  |                 |   |         |          |            |
| <b>DATA PORT</b><br>     | 01-RJ4DATA  |          | -                | -               | - | -       | -        | \$ 156     |
|   | <b>Description</b>  |          |                  |                 |   |         |          |            |
|   | <ul style="list-style-type: none"> <li>• 8-Pin Modular Plug; Cat 5 Ethernet Cable; Pre-terminated Cable</li> <li>• 9' Cord</li> <li>• Compatible with 01-DPORT4</li> </ul>  |          |                  |                 |   |         |          |            |

[See Aura Overview For Ordering Options](#)

| Item   | Model No. |        | W                 | D                 | H | Ship Wt | Cubic Ft | List Price |
|--|-----------|--------|-------------------|-------------------|---|---------|----------|------------|
| ROUND GROMMET COVER<br>                             | 01-GRMTB  | Black  | 2 $\frac{3}{8}$ " | 2 $\frac{3}{8}$ " | - | 1       | 0.1      | \$ 33      |
|  | 01-GRMTSL | Silver | 2 $\frac{3}{8}$ " | 2 $\frac{3}{8}$ " | - | 1       | 0.1      | \$ 33      |
| <i>Open Market Only</i>  |           |        |                   |                   |   |         |          |            |
| <b>Description</b>   |           |        |                   |                   |   |         |          |            |
| <ul style="list-style-type: none"> <li>• 2<math>\frac{3}{8}</math>" (60mm) Round Grommet Cover</li> <li>• Field Installed</li> </ul> |           |        |                   |                   |   |         |          |            |
| <b>Option: Specify</b>   |           |        |                   |                   |   |         |          |            |
| Factory Installed  |           |        |                   |                   |   |         |          | \$ 72      |

|   |             |        |   |   |   |   |     |       |
|---|-------------|--------|---|---|---|---|-----|-------|
| SINGLE POWER SAND DOLLAR<br>   | 01-SAND60PS | Silver | 3 | 3 | 4 | 1 | 0.2 | \$ 92 |
|   | 01-SAND60PW | White  |   |   |   |   |     | \$ 92 |
|   | 01-SAND60PB | Black  |   |   |   |   |     | \$ 92 |
| <b>Description</b>  |             |        |   |   |   |   |     |       |
| <ul style="list-style-type: none"> <li>• Mounts in 2<math>\frac{3}{8}</math>" (60mm) Round Grommet</li> <li>• Single Power Outlet with 6' Cord</li> </ul> |             |        |   |   |   |   |     |       |

|  |             |        |   |   |   |   |     |        |
|--|-------------|--------|---|---|---|---|-----|--------|
| DOUBLE USB SAND DOLLAR<br>  | 01-SAND60US | Silver | 3 | 3 | 4 | 1 | 0.2 | \$ 260 |
|  | 01-SAND60UW | White  |   |   |   |   |     | \$ 260 |
|  | 01-SAND60UB | Black  |   |   |   |   |     | \$ 260 |
| <b>Description</b>   |             |        |   |   |   |   |     |        |
| <ul style="list-style-type: none"> <li>• Mounts in 2<math>\frac{3}{8}</math>" (60mm) Round Grommet</li> <li>• Dual USB Outlets with 6' Cord</li> </ul> |             |        |   |   |   |   |     |        |

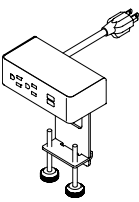
|   |              |        |                   |   |   |   |     |        |
|---|--------------|--------|-------------------|---|---|---|-----|--------|
| DUO CLAMP NEMA PLUG<br>  | 01-DUOCLAMPS | Silver | 6 $\frac{1}{2}$ " | 3 | 7 | 1 | 0.2 | \$ 537 |
|   | 01-DUOCLAMPW | White  |                   |   |   |   |     | \$ 537 |
|   | 01-DUOCLAMPB | Black  |                   |   |   |   |     | \$ 537 |
| <b>Description</b>  |              |        |                   |   |   |   |     |        |
| <ul style="list-style-type: none"> <li>• Silver Metal Trim</li> <li>• Clamps to Top</li> <li>• Two (2) Power/Two (2) USB</li> <li>• Independent USB Circuit Controllers Deliver up to 2.1 Amps to Each Post</li> <li>• All Mounting Hardware Included</li> <li>• FCC Part 15A and UL Approved for Horizontal and Vertical Applications</li> <li>• 10' Cord</li> </ul> |              |        |                   |   |   |   |     |        |

[See Aura Overview For Ordering Options](#)

| Item                 | Model No.     |        | W | D | H | Ship Wt | Cubic Ft | List Price |
|----------------------|---------------|--------|---|---|---|---------|----------|------------|
| TRIO CLAMP NEMA PLUG | 01-TRIOCLAMPS | Silver | 8 | 3 | 7 | 1       | 0.2      | \$ 629     |
|                      | 01-TRIOCLAMPW | White  |   |   |   |         |          | \$ 629     |
|                      | 01-TRIOCLAMPS | Black  |   |   |   |         |          | \$ 629     |

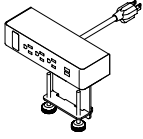

#### Description

- Silver Metal Trim
- Clamps to Top
- Three (3) Power/Two (2) USB Power/One (1) Open Data; 10' Cord
- Independent USB Circuit Controllers Deliver up to 2.1 Amps to Each Post
- HDMI, VGA, or RJ45 Accessories Sold Separately; See Below
- All Mounting Hardware Included
- FCC Part 15A and UL Approved for Horizontal and Vertical Applications

|   |             |  |   |   |   |   |     |        |
|---|-------------|--|---|---|---|---|-----|--------|
| HDMI DATA PORT ACCESSORY FOR TRIO UNITS | 01-LCOMHDMI |  | - | - | - | 1 | 0.2 | \$ 155 |
|---|-------------|--|---|---|---|---|-----|--------|

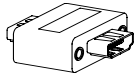

Open Market

|  |            |  |   |   |   |   |     |        |
|--|------------|--|---|---|---|---|-----|--------|
| VGA DATA PORT ACCESSORY FOR TRIO UNITS | 01-LCOMVGA |  | - | - | - | 1 | 0.2 | \$ 114 |
|--|------------|--|---|---|---|---|-----|--------|

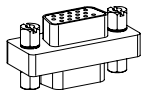

|   |             |  |   |   |   |   |     |       |
|---|-------------|--|---|---|---|---|-----|-------|
| RJ45 DATA PORT ACCESSORY FOR TRIO UNITS | 01-LCOMRJ45 |  | - | - | - | 1 | 0.2 | \$ 74 |
|---|-------------|--|---|---|---|---|-----|-------|

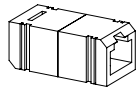

| Item               | Model No. | W   | D  | H   | Ship Wt | Cubic Ft | List Price |
|--------------------|-----------|-----|----|-----|---------|----------|------------|
| VESTA POWER CENTER | 01-PDCTR  | 10¾ | 12 | 28¾ | 14      | 2.5      | \$ 1666    |



### Description

- Top Includes One (1) Power Outlet, Two (2) USB Ports and One (1) USBC Port; Base Includes Three
- Available in White
- 120" Power Cord
- Built with Weight Distribution for Optimal Stability
- Base is 5" Tall

|                         |          |    |    |   |   |   |        |
|-------------------------|----------|----|----|---|---|---|--------|
| WIRE MANAGEMENT CHANNEL | 01-WMGR4 | 16 | 1½ | ¾ | 1 | - | \$ 109 |
|-------------------------|----------|----|----|---|---|---|--------|

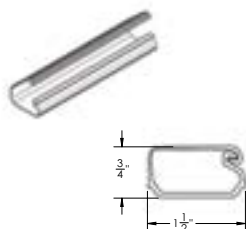

### Description

- Four (4) Wire Manager Strips
- Black Plastic
- Snap Lock Channel
- Attaches with Adhesive Strips
- Can be Placed on All Units to Route Wires

|            |           |    |    |   |   |   |       |
|------------|-----------|----|----|---|---|---|-------|
| CABLE GRIP | 01-WMGRCB | 5¾ | 2½ | - | - | - | \$ 16 |
|------------|-----------|----|----|---|---|---|-------|

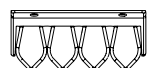

### Description

- Under Surface Wire Management
- Black

|             |         |   |   |   |   |   |        |
|-------------|---------|---|---|---|---|---|--------|
| POWER STRIP | 01-PRSP | 9 | 2 | 2 | 1 | - | \$ 192 |
|-------------|---------|---|---|---|---|---|--------|



### Description

- Includes Four (4) Outlets and Two (2) Phone Jacks
- Black Plastic with Rocker On/Off Switch
- 13 Amp Circuit Breaker
- 10' Power Cord and Two (2) 14' Phone Hook Up Cords
- UL Listed and CSA Certified
- Suitable for Surface or Recessed Mounting
- Ships via UPS Only

[See Aura Overview For Ordering Options](#)



| Item               | Model No.     | Description  | List Price |
|--------------------|---------------|--|------------|
| ECA TELECOM PLATES | 01-ABL        | Telecom Plate, Blank Plate   | \$ 39      |
|                    | 01-ABL737373  | Telecom Plate, Three (3) RJ45 Cat 5e   | \$ 345     |
|                    | 01-ABLAB      | Telecom Plate, One (1) RJ45 Cat 6, One (1) RJ11 Cat 3 Phone  | \$ 193     |
|                    | 01-ABLAB102   | Telecom Plate, One (1) RJ45 Cat 6, One (1) RJ11 Cat 3, One (1) USB W/72" Patch Cord                              | \$ 300     |
|                    | 01-ABLABB     | Telecom Plate, Two (2) RJ45 Cat 6, One (1) RJ11 Cat 3 Phone  | \$ 300     |
|                    | 01-ABLB       | Telecom Plate, One (1) RJ45 Cat 6  | \$ 140     |
|                    | 01-ABLBB      | Telecom Plate, Two (2) RJ45 Cat 6  | \$ 244     |
|                    | 01-ABLBBB     | Telecom Plate, Three (3) RJ45 Cat 6  | \$ 345     |
|                    | 01-ABLBBBB    | Telecom Plate, Four (4) RJ45 Cat 6   | \$ 447     |
|                    | 01-ABLBBC51   | Telecom Plate, Two (2) RJ45 Cat 6, One (1) 15 Pin HD VGA w/72" Patch Cord  | \$ 418     |
|                    | 01-ABLBC51L   | Telecom Plate, One (1) RJ45 Cat 6, One (1) Mini Stereo Inline, One (1) 15 Pin HD VGA w/72" Patch Cord            | \$ 384     |
|                    | 01-ABLC3811   | Telecom Plate, One (1) RJ45 Cat 6 Data Inline, One (1) RJ11 Cat 3 Phone Inline                                   | \$ 184     |
|                    | 01-ABLC45     | Telecom Plate, One (1) HDMI w/36" Patch Cord   | \$ 277     |
|                    | 01-ABLC45C51L | Telecom Plate, One (1) Mini Stereo Inline, One (1) HDMI w/36" Patch Cord, One (1) 15 Pin HD VGA w/72" Patch Cord | \$ 523     |
|                    | 01-ABLC51L    | Telecom Plate, One (1) 15 Pin HD VGA & One (1) Mini Stereo Inline Jack   | \$ 280     |
|                    | 01-ABLCRDM    | Telecom Plate, Three (3) Cord Bushings   | \$ 90      |

Compatible with:



Oasis Mini Power & Data  
01-OASISMA, 01-OASISMB



Interact Power & Data  
01-INTERACTG2A, 01-INTERACTG2B



Power Center  
01-INTRFCIA, 01-INTRFCIB



Traditional components echo history and create timeless foundations for meeting rooms that complement our Jefferson and Arlington casegoods collections, and Cameo and Jefferson Reception options. Facilitate presentations with lecterns and visual presentation boards. Mobile serving carts and buffet height credenzas provide additional in-room utility.

### CONSTRUCTION

*Cameo Tables and Components feature your choice of either a Veneer or HPL top, Veneer bases, and Veneer chassis (where applicable).*

### VENEERS

- Veneers on exposed surfaces are select grade sliced American Black Walnut and are carefully selected and matched to assure proper balance and consistency

### LAMINATES

- Exposed surfaces are produced from wood grained laminates fused to a particle-board core
- Each laminate offers lasting beauty, superior resistance to normal wear, and easy maintenance

### TOPS

- Wood Veneer tops are 5-ply balanced construction and High Pressure Laminate (HPL) tops are 3-ply balanced construction
- Tops are 1 $\frac{3}{16}$ " thick with solid hardwood rims
- All buffets, credenzas, serving carts, video cabinets, and storage/wardrobe cabinets are shaped on user side only
- Grain direction runs left to right unless otherwise noted

### CHASSIS

- Tops and end panels are securely fastened using high quality
- European fastening systems to ensure maximum strength
- All units are equipped with heavy-duty, adjustable glides to ensure proper leveling and compensation for uneven floors

### DRAWERS

- All drawer fronts are standard with elegant vertically matched walnut veneer faces
- Drawers feature 5-sided construction with  $\frac{3}{4}$ " 3-ply fronts,  $\frac{7}{16}$ " thick hardwood sides and  $\frac{5}{32}$ " hardboard bottoms
- Units with 36" wide file drawers feature  $\frac{1}{4}$ " thick drawer bottoms for maximum storage strength
- Drawer interiors are sanded, sealed, and finished to provide for a smooth, quality feel and appearance
- All drawers feature full extension, progressive action slides with precision steel ball bearings
- Box and file drawers are tested for 100lb capacity
- Lateral files are tested for 200lb capacity
- All suspensions have a limited lifetime warranty

### STORAGE

- All hinged doors include soft close hinges, unless otherwise noted
- One piece hinge and base plate combination
- Soft close hinges reduce stress placed on the cabinet when the door is closed and offers a quiet closure

### LOCKING

- All units with file drawers feature locking
- Removable lock cylinders allow for units to be re-keyed at a later date if required
- Units are shipped randomly keyed as standard. Keyed alike units available upon request at no additional charge.
- Keyed alike units available upon request at no additional charge
- Lock cores match pull color

### INTERIOR DRAWER DIMENSIONS & FILING CAPABILITIES

#### Models

91-2472BFD 91-2436SV

#### Drawers

Box

**W**

14 $\frac{17}{32}$ "

**L**

19 $\frac{1}{4}$ "

**D**

3 $\frac{21}{32}$ "

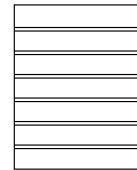

Legal Front to Back

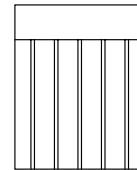

Legal Side to Side

#### Models

91-2436BF 91-2472BF

#### Drawers

Box

**W**

32 $\frac{9}{16}$ "

**L**

19 $\frac{1}{4}$ "

**D**

3 $\frac{21}{32}$ "

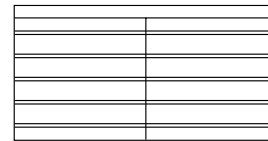

2 Rows Letter or Legal Front to Back

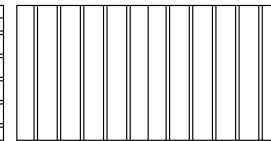

1 Row Letter or Legal Side to Side

#### Models

91-2472SBF

#### Drawers

Box

**W**

14 $\frac{17}{32}$ "

**L**

19 $\frac{1}{4}$ "

**D**

3 $\frac{21}{32}$ "

Box

32 $\frac{9}{16}$ "

19 $\frac{1}{4}$ "

3 $\frac{21}{32}$ "

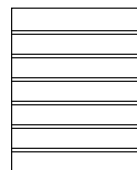

Legal Front to Back

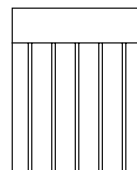

Legal Side to Side

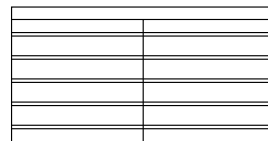

2 Rows Letter or Legal Front to Back

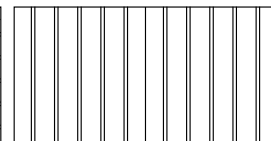

1 Row Letter or Legal Side to Side

**HOW TO ORDER EXAMPLES**

|                      | QTY | MODEL NO.  | DESCRIPTION                     | EXAMPLE |
|----------------------|-----|------------|---------------------------------|---------|
| <b>TOP</b>           | 1   | 91-4296RT  | Top Material                    | W       |
|                      |     |            | Finish/Color                    | EW      |
|                      |     |            | Edge Profile                    | C2      |
|                      |     |            | Grommet/Power/<br>Data Location | EL      |
|                      |     |            |                                 |         |
| <b>BASES</b>         | 2   | 01-2028TB  | Finish                          | EW      |
| <b>PORTS</b>         | 2   | 01-OASISMA |                                 |         |
| <b>TELECOM PLATE</b> | 1   | 01-ABLAB   |                                 |         |
| <b>MOBILE CART</b>   | 1   | 91-2436SV  | Top Material                    | P       |
|                      |     |            | Finish/Color                    | EW      |
|                      |     |            | Edge Profile                    | C2      |
|                      |     |            | Pull                            | ALB     |
|                      |     |            | Back Panel                      | 1-GRMT  |
|                      |     |            | Grommet<br>Grommet Color        | Black   |

**VENEER (W) OPTIONS**

Veneer features UVAdvantage, an ultra-violet finish, on all exposed surfaces by utilizing roll-coat UV technology

|     |                    |    |                 |
|-----|--------------------|----|-----------------|
| AW  | Artisan Walnut     | HW | Harvest Walnut  |
| CO  | Columbian Walnut   | LW | Legacy Walnut   |
| DFW | Dark Forest Walnut | MW | Mahogany Walnut |
| EW  | Espresso           |    |                 |

**HPL (P) LAMINATE**

|                  |                  |    |                 |
|------------------|------------------|----|-----------------|
| <b>WOODGRAIN</b> |                  |    |                 |
| CO               | Columbian Walnut | MW | Mahogany Walnut |
| EW               | Espresso         |    |                 |

**EDGE PROFILES**

C2 Jefferson  
R Arlington



Jefferson (C2)



Arlington (R)

**PULL OPTIONS**

|     |                    |     |                   |
|-----|--------------------|-----|-------------------|
| ARA | Arlington A, Brass | ALB | Liberty, Aluminum |
| ARB | Arlington B, Brass | WLM | Wilmington, Brass |
| JEF | Jefferson, Brass   |     |                   |



**Arlington A (ARA)**  
Antique Brass - 5¼"



**Arlington B (ARB)**  
Antique Brass - 5¼"



**Jefferson (JEF)**  
Antique Brass - 5¼"



**Wilmington (WLM)**  
Antique Brass - 5¼"



**Liberty (ALB)**  
Aluminum - 4¼"

**GROMMET/POWER/DATA OPTIONS & LOCATIONS**

See units and options in [accessories section](#) and the [general power and locations information section](#)

**LOCKING DOORS**

Locking doors are available on specific units, where noted. You must specify WITH LOCKING when ordering and add upcharge.

|        |                     |    |     |
|--------|---------------------|----|-----|
| LKT_HU | 72" W - 48" W Units | \$ | 108 |
| LKT_HU | 42" W - 24" W Units | \$ | 85  |
| LKT_HU | 18" W Units         | \$ | 65  |

**CERTIFICATIONS & COMPLIANCE**

- Intertek Sustainability Certified
- BIFMA level® Certified
- BIFMA Compliant® Certified
- TSCA Title VI (formerly CARB) Compliance
- US Green Building's LEED® Contribution

**Tops/Shapes**

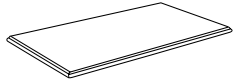

Rectangular [\(See Details\)](#)

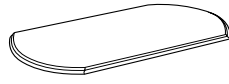

Arc Rectangular [\(See Details\)](#)



Racetrack [\(See Details\)](#)



Boat-Shaped [\(See Details\)](#)

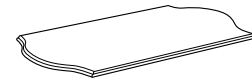

Wave-Rectangular [\(See Details\)](#)

**Bases**

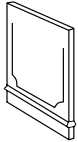

Rectangular [\(See Details\)](#)

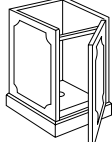

Square [\(See Details\)](#)

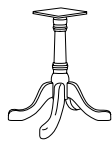

Queen Anne Base [\(See Details\)](#)

**Storage Components**

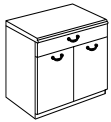

Two Door Buffet w/Drawer [\(See Details\)](#)

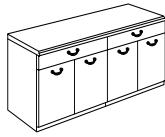

Four Door Buffet w/2 Drawers [\(See Details\)](#)

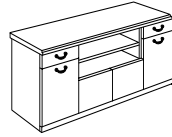

Four Door Buffet w/2 Drawers & Open Storage [\(See Details\)](#)

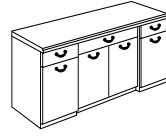

Four Door Buffet w/3 Drawers [\(See Details\)](#)

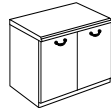

Two Door Credenza [\(See Details\)](#)

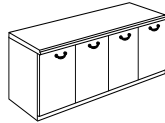

Four Door Credenza [\(See Details\)](#)

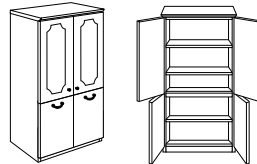

Storage Cabinet Double Doors [\(See Details\)](#)

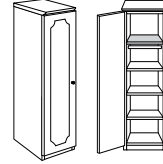

Wardrobe/Storage Cabinet [\(See Details\)](#)



Mobile Serving Cart [\(See Details\)](#)

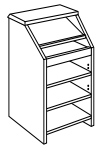

Lectern Stand [\(See Details\)](#)

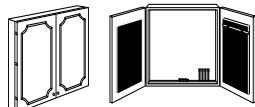

Visual Board [\(See Details\)](#)

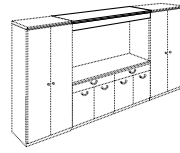

Visor Rail [\(See Details\)](#)

**Wire Management & Power/Data Accessories**

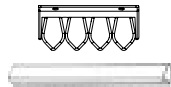
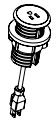

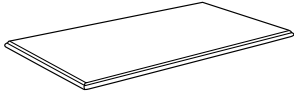
| Item   | Model No.                         | W   | D  | H                | Ship Wt | Cubic Ft | List Price           |  |
|--|-----------------------------------|-----|----|------------------|---------|----------|----------------------|--|
|  <p>RECTANGULAR TOPS</p> <p>Must Specify (in this order):<br/>           Model #<br/>           Top Material<br/>           Finish/Color<br/>           Edge Profile<br/>           Grommet/Power/Data Location</p> | <b>192" or 16' - 2 Piece Tops</b> |     |    |                  |         |          |                      |  |
|  | 91-48192RT                        | 192 | 48 | 1 $\frac{3}{16}$ | 375     | 15.5     | P\$ 7317<br>W\$ 9201 |  |
|  | <b>168" or 14' - 2 Piece Tops</b> |     |    |                  |         |          |                      |  |
|  | 91-48168RT                        | 168 | 48 | 1 $\frac{3}{16}$ | 325     | 13.6     | P\$ 7214<br>W\$ 8574 |  |
|  | <b>144" or 12' - 2 Piece Tops</b> |     |    |                  |         |          |                      |  |
|  | 91-48144RT                        | 144 | 48 | 1 $\frac{3}{16}$ | 275     | 12.3     | P\$ 6067<br>W\$ 7114 |  |
|  | <b>120" or 10' - 2 Piece Tops</b> |     |    |                  |         |          |                      |  |
|  | 91-48120RT                        | 120 | 48 | 1 $\frac{3}{16}$ | 225     | 10.3     | P\$ 5437<br>W\$ 6273 |  |
|  | <b>96" or 8' - 1 Piece Top</b>    |     |    |                  |         |          |                      |  |
|  | 91-4296RT                         | 96  | 42 | 1 $\frac{3}{16}$ | 180     | 9.4      | P\$ 4080<br>W\$ 4704 |  |
|  | <b>72" or 6' - 1 Piece Top</b>    |     |    |                  |         |          |                      |  |
|  | 91-3672RT                         | 72  | 36 | 1 $\frac{3}{16}$ | 100     | 6.2      | P\$ 2655<br>W\$ 3134 |  |

### Description

- Grain Runs the Width of the Table
- Heavy-Duty Ganging Mechanisms Connect Two (2) Piece Tops
- See Bases and Number Required For Each Top Size, [See Multiple Base Options](#); Must Order Separately
- Optional Grommets and Power/Data; For Locations See [General Power and Locations Information Section](#), See Units and Unit Options in [Accessories Section](#)

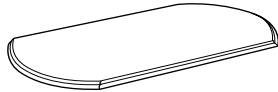
| Item   | Model No.                         | W   | D  | H                | Ship Wt | Cubic Ft | List Price           |  |
|--|-----------------------------------|-----|----|------------------|---------|----------|----------------------|--|
|  <p>ARC RECTANGULAR TOPS</p> <p>Must Specify (in this order):<br/>           Model #<br/>           Top Material<br/>           Finish/Color<br/>           Edge Profile<br/>           Grommet/Power/Data Location</p> | <b>192" or 16' - 2 Piece Tops</b> |     |    |                  |         |          |                      |  |
|  | 91-48192AR                        | 192 | 48 | 1 $\frac{3}{16}$ | 375     | 15.5     | P\$ 7737<br>W\$ 9618 |  |
|  | <b>168" or 14' - 2 Piece Tops</b> |     |    |                  |         |          |                      |  |
|  | 91-48168AR                        | 168 | 48 | 1 $\frac{3}{16}$ | 325     | 13.6     | P\$ 7633<br>W\$ 8992 |  |
|  | <b>144" or 12' - 2 Piece Tops</b> |     |    |                  |         |          |                      |  |
|  | 91-48144AR                        | 144 | 48 | 1 $\frac{3}{16}$ | 275     | 12.3     | P\$ 6483<br>W\$ 7526 |  |
|  | <b>120" or 10' - 2 Piece Tops</b> |     |    |                  |         |          |                      |  |
|  | 91-48120AR                        | 120 | 48 | 1 $\frac{3}{16}$ | 225     | 10.3     | P\$ 5856<br>W\$ 6693 |  |
|  | <b>96" or 8' - 1 Piece Top</b>    |     |    |                  |         |          |                      |  |
|  | 91-4296AR                         | 96  | 42 | 1 $\frac{3}{16}$ | 180     | 9.4      | P\$ 4600<br>W\$ 5226 |  |
|  | <b>72" or 6' - 1 Piece Top</b>    |     |    |                  |         |          |                      |  |
|  | 91-3672AR                         | 72  | 36 | 1 $\frac{3}{16}$ | 100     | 6.2      | P\$ 2930<br>W\$ 3408 |  |

### Description

- Grain Runs the Width of the Table
- Heavy-Duty Ganging Mechanisms Connect (2) Piece Tops
- See Bases and Number Required For Each Top Size, [See Multiple Base Options](#); Must Order Separately
- Optional Grommets and Power/Data; For Locations See [General Power and Locations Information Section](#), See Units and Unit Options in [Accessories Section](#)

W = Veneer P = HPL

For ordering options, see overview at the beginning of this section.

| Item  | Model No.                         | W   | D  | H                | Ship Wt | Cubic Ft | List Price            |  |
|---|-----------------------------------|-----|----|------------------|---------|----------|-----------------------|--|
|  <p><b>RACETRACK TOPS</b></p> <p>Must Specify (in this order):<br/>           Model #<br/>           Top Material<br/>           Finish/Color<br/>           Edge Profile<br/>           Grommet/Power/Data Location</p> | <b>192" or 16' - 2 Piece Tops</b> |     |    |                  |         |          |                       |  |
|   | 91-48192AT                        | 192 | 48 | 1 $\frac{3}{16}$ | 375     | 15.5     | P\$ 8992<br>W\$ 10872 |  |
|   | <b>168" or 14' - 2 Piece Tops</b> |     |    |                  |         |          |                       |  |
|   | 91-48168AT                        | 168 | 48 | 1 $\frac{3}{16}$ | 325     | 13.6     | P\$ 8679<br>W\$ 10037 |  |
|   | <b>144" or 12' - 2 Piece Tops</b> |     |    |                  |         |          |                       |  |
|   | 91-48144AT                        | 144 | 48 | 1 $\frac{3}{16}$ | 275     | 12.3     | P\$ 7423<br>W\$ 8470  |  |
|   | <b>120" or 10' - 2 Piece Tops</b> |     |    |                  |         |          |                       |  |
|   | 91-48120AT                        | 120 | 48 | 1 $\frac{3}{16}$ | 225     | 10.3     | P\$ 6589<br>W\$ 7423  |  |
|   | <b>96" or 8' - 1 Piece Top</b>    |     |    |                  |         |          |                       |  |
|   | 91-4296AT                         | 96  | 42 | 1 $\frac{3}{16}$ | 180     | 9.4      | P\$ 5016<br>W\$ 5645  |  |
|   | <b>72" or 6' - 1 Piece Top</b>    |     |    |                  |         |          |                       |  |
|   | 91-3672AT                         | 72  | 36 | 1 $\frac{3}{16}$ | 100     | 6.2      | P\$ 3494<br>W\$ 3971  |  |

### Description

- Grain Runs the Width of the Table
- Heavy-Duty Ganging Mechanisms Connect (2) Piece Tops
- See Bases and Number Required For Each Top Size, [See Multiple Base Options](#); Must Order Separately
- Optional Grommets and Power/Data; For Locations See [General Power and Locations Information Section](#), See Units and Unit Options in [Accessories Section](#)

|   |                                   |     |    |                  |     |      |                       |  |
|---|-----------------------------------|-----|----|------------------|-----|------|-----------------------|--|
|  <p><b>BOAT-SHAPED TOPS</b></p> <p>Must Specify (in this order):<br/>           Model #<br/>           Top Material<br/>           Finish/Color<br/>           Edge Profile<br/>           Grommet/Power/Data Location</p> | <b>192" or 16' - 2 Piece Tops</b> |     |    |                  |     |      |                       |  |
|   | 91-48192BT                        | 192 | 48 | 1 $\frac{3}{16}$ | 375 | 15.5 | P\$ 8992<br>W\$ 10872 |  |
|   | <b>168" or 14' - 2 Piece Tops</b> |     |    |                  |     |      |                       |  |
|   | 91-48168BT                        | 168 | 48 | 1 $\frac{3}{16}$ | 325 | 13.6 | P\$ 8679<br>W\$ 10037 |  |
|   | <b>144" or 12' - 2 Piece Tops</b> |     |    |                  |     |      |                       |  |
|   | 91-48144BT                        | 144 | 48 | 1 $\frac{3}{16}$ | 275 | 12.3 | P\$ 7423<br>W\$ 8470  |  |
|   | <b>120" or 10' - 2 Piece Tops</b> |     |    |                  |     |      |                       |  |
|   | 91-48120BT                        | 120 | 48 | 1 $\frac{3}{16}$ | 225 | 10.3 | P\$ 6589<br>W\$ 7423  |  |
|   | <b>96" or 8' - 1 Piece Top</b>    |     |    |                  |     |      |                       |  |
|   | 91-4296BT                         | 96  | 42 | 1 $\frac{3}{16}$ | 180 | 9.4  | P\$ 5016<br>W\$ 5645  |  |
|   | <b>72" or 6' - 1 Piece Top</b>    |     |    |                  |     |      |                       |  |
|   | 91-3672BT                         | 72  | 36 | 1 $\frac{3}{16}$ | 100 | 6.2  | P\$ 3494<br>W\$ 3971  |  |

### Description

- Grain Runs the Width of the Table
- Heavy-Duty Ganging Mechanisms Connect (2) Piece Tops
- See Bases and Number Required For Each Top Size, [See Multiple Base Options](#); Must Order Separately
- Optional Grommets and Power/Data; For Locations See [General Power and Locations Information Section](#), See Units and Unit Options in [Accessories Section](#)

W = Veneer P = HPL

For ordering options, see overview at the beginning of this section.

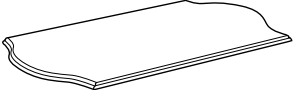
| Item  | Model No.                         | W   | D  | H   | Ship Wt | Cubic Ft | List Price           |
|---|-----------------------------------|-----|----|-----|---------|----------|----------------------|
| <b>WAVE-RECTANGULAR TOPS</b><br> | <b>192" or 16' - 2 Piece Tops</b> |     |    |     |         |          |                      |
|   | 91-48192WR                        | 192 | 48 | 1¾" | 375     | 15.5     | P\$ 7737<br>W\$ 9618 |
|   | <b>168" or 14' - 2 Piece Tops</b> |     |    |     |         |          |                      |
|   | 91-48168WR                        | 168 | 48 | 1¾" | 325     | 13.6     | P\$ 7633<br>W\$ 8992 |
|   | <b>144" or 12' - 2 Piece Tops</b> |     |    |     |         |          |                      |
|   | 91-48144WR                        | 144 | 48 | 1¾" | 275     | 12.3     | P\$ 6483<br>W\$ 7526 |
|   | <b>120" or 10' - 2 Piece Tops</b> |     |    |     |         |          |                      |
|   | 91-48120WR                        | 120 | 48 | 1¾" | 225     | 10.3     | P\$ 5856<br>W\$ 6693 |
|   | <b>96" or 8' - 1 Piece Top</b>    |     |    |     |         |          |                      |
|   | 91-4296WR                         | 96  | 42 | 1¾" | 180     | 9.4      | P\$ 4600<br>W\$ 5226 |
|   | <b>72" or 6' - 1 Piece Top</b>    |     |    |     |         |          |                      |
|   | 91-3672WR                         | 72  | 36 | 1¾" | 100     | 6.2      | P\$ 2930<br>W\$ 3408 |

Must Specify (in this order):

- Model #
- Top Material
- Finish/Color
- Edge Profile
- Grommet/Power/Data Location

**Description**

- Grain Runs the Width of the Table
- Heavy-Duty Ganging Mechanisms Connect (2) Piece Tops
- See Bases and Number Required For Each Top Size, [See Multiple Base Options](#); Must Order Separately
- Optional Grommets and Power/Data; For Locations See [General Power and Locations Information Section](#), See Units and Unit Options in [Accessories Section](#)

**RECTANGULAR BASE  
TRADITIONAL**

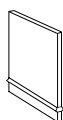
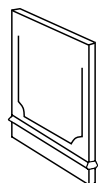

| <b>For Use with 48"D Tops</b>         |    |   |      |    |     |     |      |
|---------------------------------------|----|---|------|----|-----|-----|------|
| 01-2428TB                             | 24 | 2 | 28½" | 38 | 2.7 | W\$ | 1397 |
| <b>For Use with 42"D or Less Tops</b> |    |   |      |    |     |     |      |
| 01-2028TB                             | 20 | 2 | 28½" | 32 | 2.3 | W\$ | 1311 |

**Description**

- Veneer Panel Base
- Traditional Molding on Outer Side Standard; For No Decorative Molding Option, Must Specify (See Below)
- Stretchers are Included in Pricing; Must Specify Model (See Below)

**Molding Option: Specify**

|      |                       |    |     |
|------|-----------------------|----|-----|
| NONE | No Decorative Molding | \$ | N/C |
|------|-----------------------|----|-----|

| Table Width                     | 72"      | 96"      | 120"      | 144"      | 168"      | 192"      |
|---------------------------------|----------|----------|-----------|-----------|-----------|-----------|
| <b>Number of Bases Required</b> | 2        | 2        | 3         | 3         | 3         | 5         |
| <b>Stretcher Rail Needed</b>    | 01-72STR | 01-96STR | 01-120STR | 01-144STR | 01-168STR | 01-192STR |

Note: Molding is applied to one side of outer extreme bases. If 3 or more bases are required, center bases will not have molding on either side.

Must Specify (in this order):

- Model # and Quantity
- Finish
- No Molding
- Stretcher Rail

W = Veneer P = HPL

For ordering options, see overview at the beginning of this section.

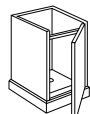
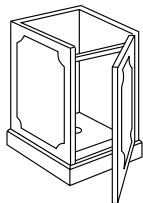
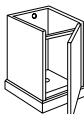

| Item                       | Model No.  | W  | D  | H   | Ship Wt | Cubic Ft | List Price |
|----------------------------|------------|----|----|-----|---------|----------|------------|
| SQUARE BASE<br>TRADITIONAL | 01-2020TSB | 20 | 20 | 28½ | 57      | 8.4      | W\$ 1907   |

No Molding  
OptionGrommet  
Option**Description**

- Panel Access Door Features Soft Close Hinges
- Traditional Molding Standard on All Sides; For No Decorative Molding Option, Must Specify (See Below)
- 2" Wire Management Opening Above Door; 2¾" (60mm) Wire Management Opening in Bottom
- Optional Grommet at Top Edge, Must Specify (See Below)

**Options: Specify & Add**

|       |   |    |     |
|-------|---|----|-----|
| NONE  | No Decorative Molding                           | \$ | N/C |
| GCB1S | Grommet at Top Edge One (1) - Factory Installed | \$ | 72  |

|                                 |            |            |             |             |             |             |
|---------------------------------|------------|------------|-------------|-------------|-------------|-------------|
| <b>Table Width</b>              | <b>72"</b> | <b>96"</b> | <b>120"</b> | <b>144"</b> | <b>168"</b> | <b>192"</b> |
| <b>Number of Bases Required</b> | 2          | 2          | 3           | 3           | 3           | 3           |

Note: Recommended on tables 72"W or Larger. If specified on smaller tables, a ballast must be ordered separately. Contact Customer Service for more information.

Must Specify (in this order):

- Model # and Quantity
- Finish
- No Molding
- Grommet Option

|                 |           |    |    |     |    |      |          |
|-----------------|-----------|----|----|-----|----|------|----------|
| QUEEN ANNE BASE | 01-0606QB | 22 | 22 | 28½ | 35 | 10.8 | W\$ 1318 |
|-----------------|-----------|----|----|-----|----|------|----------|

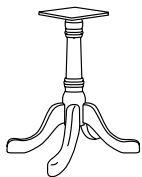
**Description**

- Classic Design Detail on Column
- Queen Anne Base Features Multi-Step, Hand-Finished Catalyzed Finish
- Four (4) Legs with Adjustable Glides

|                                 |            |            |             |             |             |             |
|---------------------------------|------------|------------|-------------|-------------|-------------|-------------|
| <b>Table Width</b>              | <b>72"</b> | <b>96"</b> | <b>120"</b> | <b>144"</b> | <b>168"</b> | <b>192"</b> |
| <b>Number of Bases Required</b> | 2          | 2          | 3           | 3           | 3           | 5           |

Must Specify (in this order):

- Model # and Quantity
- Finish

W = Veneer P = HPL

For ordering options, see overview at the beginning of this section.

| Item                               | Model No. | W  | D  | H  | Ship Wt | Cubic Ft | List Price           |
|------------------------------------|-----------|----|----|----|---------|----------|----------------------|
| <b>TWO DOOR BUFFET WITH DRAWER</b> | 91-2436BF | 36 | 24 | 36 | 189     | 21.7     | P\$ 3952<br>W\$ 4024 |

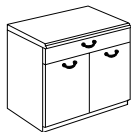
**Description**

- Top Edge Profiled on Approach Side Only ([See Edge Options](#)); Must Specify Edge Selection
- One (1) Drawer and Storage Behind Two (2) Doors with One (1) Adjustable Shelf

Must Specify (in this order):

Model #  
Top Material  
Finish/Color  
Edge Profile  
Pull

|  |           |    |    |    |     |      |                      |
|--|-----------|----|----|----|-----|------|----------------------|
| <b>FOUR DOOR BUFFET WITH TWO DRAWERS</b> | 91-2472BF | 72 | 24 | 36 | 342 | 45.6 | P\$ 7509<br>W\$ 7633 |
|--|-----------|----|----|----|-----|------|----------------------|

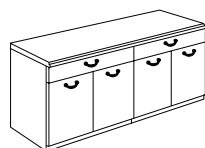
**Description**

- Top Edge Profiled on Approach Side Only ([See Edge Options](#)); Must Specify Edge Selection
- Two (2) Drawers and Storage Behind Four (4) Doors with Two (2) Adjustable Shelves

Must Specify (in this order):

Model #  
Top Material  
Finish/Color  
Edge Profile  
Pull

|   |            |    |    |    |     |      |                      |
|---|------------|----|----|----|-----|------|----------------------|
| <b>FOUR DOOR BUFFET WITH TWO DRAWERS AND OPEN STORAGE</b> | 91-2472BFD | 72 | 24 | 36 | 337 | 45.6 | P\$ 8659<br>W\$ 8785 |
|---|------------|----|----|----|-----|------|----------------------|

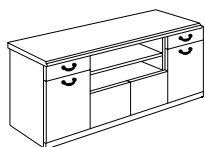
**Description**

- Top Edge Profiled on Approach Side Only ([See Edge Options](#)); Must Specify Edge Selection
- Two (2) Drawers with Open Storage with One (1) Adjustable Shelf
- Left and Right Storage Behind Doors with One (1) Adjustable Shelf
- Storage Behind Center Doors

Must Specify (in this order):

Model #  
Top Material  
Finish/Color  
Edge Profile  
Pull

|  |            |    |    |    |     |      |                      |
|--|------------|----|----|----|-----|------|----------------------|
| <b>FOUR DOOR BUFFET WITH THREE DRAWERS</b> | 91-2472SBF | 72 | 24 | 36 | 362 | 45.6 | P\$ 8659<br>W\$ 8785 |
|--|------------|----|----|----|-----|------|----------------------|

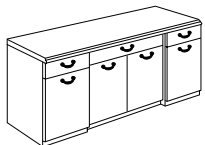
**Description**

- Top Edge Profiled on Approach Side Only ([See Edge Options](#)); Must Specify Edge Selection
- Three (3) Drawers and Storage Behind Four (4) Doors with Three (3) Adjustable Shelves
- Center Section is Stepped Back

Must Specify (in this order):

Model #  
Top Material  
Finish/Color  
Edge Profile  
Pull

W = Veneer P = HPL

For ordering options, see overview at the beginning of this section.

| Item              | Model No. | W  | D  | H  | Ship Wt | Cubic Ft | List Price           |
|-------------------|-----------|----|----|----|---------|----------|----------------------|
| TWO DOOR CREDENZA | 91-2436CC | 36 | 24 | 30 | 150     | 17.6     | P\$ 3062<br>W\$ 3134 |

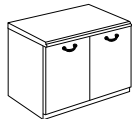

Must Specify (in this order):

Model #  
Top Material  
Finish/Color  
Edge Profile  
Pull  
Locking Option

**Description**

- Top Edge Profiled on Approach Side Only ([See Edge Options](#)); Must Specify Edge Selection
- Two (2) Doors with One (1) Adjustable Shelf Behind Doors
- Additional Option: Locking Doors ([See Locking Options](#))

|                    |           |    |    |    |     |      |                      |
|--------------------|-----------|----|----|----|-----|------|----------------------|
| FOUR DOOR CREDENZA | 91-2472CC | 72 | 24 | 30 | 290 | 34.2 | P\$ 6203<br>W\$ 6328 |
|--------------------|-----------|----|----|----|-----|------|----------------------|

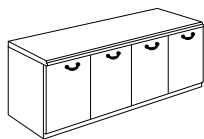

Must Specify (in this order):

Model #  
Top Material  
Finish/Color  
Edge Profile  
Pull  
Locking Option

**Description**

- Top Edge Profiled on Approach Side Only ([See Edge Options](#)); Must Specify Edge Selection
- Four (4) Doors with Two (2) Adjustable Shelves Behind Doors
- Additional Option: Locking Doors ([See Locking Options](#))

|                                |            |    |    |    |     |      |          |
|--------------------------------|------------|----|----|----|-----|------|----------|
| DOUBLE DOOR<br>STORAGE CABINET | 91-3672SUD | 36 | 24 | 72 | 285 | 42.0 | W\$ 6364 |
|--------------------------------|------------|----|----|----|-----|------|----------|

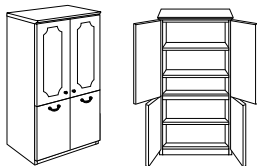

Must Specify (in this order):

Model #  
Finish  
Edge Profile  
Knob  
Pull  
No Molding

**Description**

- Top Section has Two (2) Adjustable Shelves; Bottom Section has One (1) Adjustable Shelf
- Two (2) Knobs on Top Doors, Available with Antique Brass (TKN) Door Knob or Aluminum (ALK) Door Knob; Must Specify; Selection of Pulls on Bottom Doors

**Options: Specify**

NONE      No Decorative Molding      \$      N/C

| WARDROBE/STORAGE CABINET | HINGED LEFT | HINGED RIGHT | W  | D  | H  | Ship Wt | Cubic Ft | List Price |
|--------------------------|-------------|--------------|----|----|----|---------|----------|------------|
|                          | 91-1872WL   | 91-1872WR    | 18 | 24 | 72 | 155     | 22.0     | W\$ 5067   |

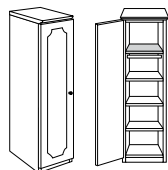

Must Specify (in this order):

Model #  
Finish  
Edge Profile  
Knob  
No Molding

**Description**

- Available with Antique Brass (TKN) Door Knob or Aluminum (ALK) Door Knob; Must Specify
- Fixed Top Shelf; Coat Rod Under Fixed Shelf
- Three (3) Adjustable Shelves Behind Door
- Adjustable Shelves can be Removed for Wardrobe Application

**Options: Specify**

NONE      No Decorative Molding      \$      N/C

W = Veneer P = HPL

For ordering options, see overview at the beginning of this section.

| Item       | Model No. | W  | D  | H                              | Ship Wt | Cubic Ft | List Price |
|------------|-----------|----|----|--------------------------------|---------|----------|------------|
| VISOR RAIL | 91-2472VR | 72 | 24 | 5 <sup>3</sup> / <sub>16</sub> | 100     | 8.9      | W\$ 1308   |

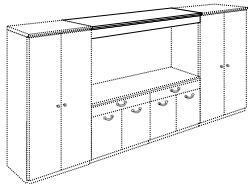

Must Specify (in this order):  
Model #  
Finish  
Projection Screen  
Task Light

**Description**

- Overhead Rail Creates Wall Unit
- For Use with 72" High Cabinets and Credenzas/Bufets (Ordered Separately)

**Options: Specify & Add**

|         |   |        |
|---------|---|--------|
| 1-PS    | Projection Screen (Requires Field Installation) | \$ 996 |
| TL-0848 | Task Light (Requires Field Installation)        | \$ 417 |

|              |           |    |    |    |     |      |                      |
|--------------|-----------|----|----|----|-----|------|----------------------|
| SERVING CART | 91-2436SV | 36 | 24 | 36 | 149 | 24.0 | P\$ 4739<br>W\$ 4814 |
|--------------|-----------|----|----|----|-----|------|----------------------|

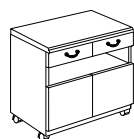

Must Specify (in this order):  
Model #  
Top Material  
Finish/Color  
Edge Profile  
Pull  
Grommet Option

**Description**

- Top Edge Profiled on Approach Side Only; Must Specify Edge Selection
- Two (2) Box Drawers with Storage Behind Two (2) Doors
- Open Storage
- Locking Casters

**Grommet Option: Specify & Add**

|        |   |       |
|--------|---|-------|
| 1-GRMT | Grommet in Back Panel; Must Specify Black or Silver | \$ 72 |
|--------|---|-------|

|               |           |    |    |    |     |      |          |
|---------------|-----------|----|----|----|-----|------|----------|
| LECTERN STAND | 91-2650LS | 26 | 24 | 50 | 130 | 21.9 | W\$ 3768 |
|---------------|-----------|----|----|----|-----|------|----------|

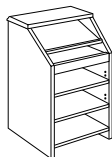

Must Specify (in this order):  
Model #  
Finish  
Edge Profile

**Description**

- Top Edge Profiled on Approach Side Only; Must Specify Edge Selection
- Fixed Reading Shelf
- Pullout Shelf
- Two (2) Adjustable Storage Shelves in Lower Compartment
- Two (2) Locking and Two (2) Non-Locking Casters
- Wire Management Grommet in Bottom Shelf

|              |           |    |   |    |     |      |          |
|--------------|-----------|----|---|----|-----|------|----------|
| VISUAL BOARD | 91-4848VB | 48 | 5 | 48 | 150 | 11.0 | W\$ 5437 |
|--------------|-----------|----|---|----|-----|------|----------|

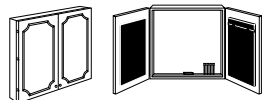

Must Specify (in this order):  
Model #  
Finish  
Project Screen  
Tackboard Fabric  
Pull

**Description**

- Tackboard on Each Door Standard in Black Fabric Unless Specified; Price Valid for Grades 1, 2, & 3 (See Other Pricing Below)
- Display Rail with Adjustable Hooks for Flipchart
- Magnetic Door Closure and Porcelain Non-Glare Writing Surface
- Includes Flipchart, Set of Four (4) Dry Erase Markers and Eraser, Mounting Hardware
- Does Not Feature Soft Close Hinges

**Options: Specify & Add**

|  | Grade 4   | Grade 5 | Grade 6 | Grade 7 | Grade 8 | Grade 9 | Grade 10 |
|--|---|---------|---------|---------|---------|---------|----------|
| TB <sup>4214</sup> Tackboard Fabric Change | \$ 260  | 382     | 506     | 684     | 866     | 1082    | 1328     |
| 1-PS                                       | Projection Screen (Requires Field Installation) |         |         |         |         |         | \$ 996   |

W = Veneer P = HPL

For ordering options, see overview at the beginning of this section.

| Item                     | Model No.    | W  | D   | H  | Ship Wt | Cubic Ft | List Price |
|--------------------------|--------------|----|-----|----|---------|----------|------------|
| TABLE POWER & DATA VAULT | 01-CVAULTG2A | 4½ | 15⅞ | 4⅞ | 10      | 0.4      | \$ 1823    |



Open Market Only

### Description

- Electric Drive Motor Rotates the Surface Technology 180° to the Proper Position
- Photo-Electronic Eye Prevents Rotation When Obstructed
- Two (2) Data Ports, Three (3) Power Outlets, and One (1) HDMI and Two (2) 5V USB
- 6' Power Cord
- UL and CSA Recognized

| Item                     | Model No.   | Material | W   | D  | H  | Ship Wt | Cubic Ft | List Price |
|--------------------------|-------------|----------|-----|----|----|---------|----------|------------|
| WORKSURFACE POWER CENTER | 01-INTRFC1A | Aluminum | 14¼ | 6⅝ | 2⅞ | 11      | 0.3      | \$ 1936    |
|                          | 01-INTRFC1B | Black    |     |    |    |         |          | \$ 1936    |



### Description

- For Use with Conference Tables
- Four (4) Power Outlets, Three (3) Telecom Plate Openings
- Two (2) Telecom Plates Included with the Unit: One (1) 01-ABLAB Plate (Consists of One (1) RJ45 Cat 6, One (1) RJ11 Cat 3 Phone Jack); One (1) 01-ABLBB Plate (Consists of Two (2) RJ45 Cat 6)
- 6' Power Cord
- Convenience Plug on Bottom
- UL Listed/CSA Certified
- Additional Telecom Plates, [See Telecom Plate Options](#)

| Item                    | Model No.  | Material | W   | D  | H  | Ship Wt | Cubic Ft | List Price |
|-------------------------|------------|----------|-----|----|----|---------|----------|------------|
| OASIS MINI POWER & DATA | 01-OASISMA | Aluminum | 14¼ | 6⅝ | 2⅞ | 11      | 0.3      | \$ 2993    |
|                         | 01-OASISMB | Black    |     |    |    |         |          | \$ 2993    |



### Description

- For Use with Conference Tables
- Soft Touch Hinged Lid
- Four (4) Power Outlets, Three (3) Telecom Plate Openings
- Two (2) Telecom Plates Included with the Unit: One (1) 01-ABLAB Plate (Consists of One (1) RJ45 Cat 6, One (1) RJ11 Cat 3 Phone Jack); One (1) 01-ABLBB Plate (Consists of One (1) RJ45 Cat 6)
- 9' Power Cord
- UL Listed
- Additional Telecom Plates, [See Telecom Plate Options](#)





| Item                  | Model No.      | Material | W | D  | H  | Ship Wt | Cubic Ft | List Price |
|-----------------------|----------------|----------|---|----|----|---------|----------|------------|
| INTERACT POWER & DATA | 01-INTERACTG2A | Aluminum | 9 | 5⅝ | 2¾ | 5       | 0.2      | \$ 836     |
|                       | 01-INTERACTG2B | Black    |   |    |    |         |          | \$ 836     |

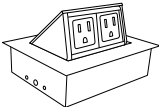

### Description

- Includes: Two (2) Power Outlets, Two (2) USB-A Charging Ports, One (1) Telecom Plate Opening; Two (2) Keystone Openings for Voice/Data Jacks
- One (1) Telecom Plates Included with the Unit: One (1) 01-ABLAB Plate (Consists of One (1) RJ45 Cat 6, One (1) RJ11 Cat 3 Phone Jack)
- Convenience Plug on Bottom
- 6' Power Cord
- UL and CSA Recognized
- Additional Telecom Plates, [See Telecom Plate Options](#)

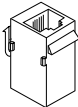
For ordering options, see overview at the beginning of this section.

| Item   | Model No.   |          | W                | D               | H | Ship Wt | Cubic Ft | List Price |
|--|-------------|----------|------------------|-----------------|---|---------|----------|------------|
|   | 01-DATA440A | Aluminum | 5 $\frac{5}{16}$ | 4 $\frac{3}{8}$ | - | 5       | 0.2      | \$ 904     |
|  | 01-DATA440B | Black    | 5 $\frac{5}{16}$ | 4 $\frac{3}{8}$ | - | 5       | 0.2      | \$ 904     |
| <b>Description</b> <ul style="list-style-type: none"> <li>• Two (2) Power Outlets</li> <li>• Soft Touch Hinged Lid</li> <li>• 6' Power Cord</li> <li>• UL and CSA Recognized</li> </ul>  |             |          |                  |                 |   |         |          |            |
|   | 01-DPORT4A  | Aluminum | 8                | 4               | - | 7       | 0.2      | \$ 1025    |
|  | 01-DPORT4B  | Black    | 8                | 4               | - | 7       | 0.2      | \$ 1025    |
| <b>Description</b> <ul style="list-style-type: none"> <li>• Retracts into Work Surface to Regain Productive Space; One-Touch Access to Power and Data</li> <li>• Two (2) Power Outlets and Two (2) Open Ports for Data</li> <li>• Additional Telecom Plates, <a href="#">See Telecom Plate Options</a></li> <li>• Water-Proof Simplex (Outlets)</li> <li>• Includes a Voice/Data Adapter Kit to Accept Couplers and Jacks When Required</li> <li>• 6' Power Cord</li> <li>• UL and CSA Recognized</li> </ul> |             |          |                  |                 |   |         |          |            |
|   | 01-USBPORT  |          | -                | -               | - | -       | -        | \$ 151     |
| <b>Description</b> <ul style="list-style-type: none"> <li>• Increases Transfer Speed Up to 5 gbs/sec</li> <li>• Simultaneous Read/Write Capability; Idle Device Power Saving State</li> <li>• 6' Cord</li> <li>• Compatible with 01-DPORT4</li> </ul>  |             |          |                  |                 |   |         |          |            |
|   | 01-VOICE1   |          | -                | -               | - | -       | -        | \$ 69      |
| <b>Description</b> <ul style="list-style-type: none"> <li>• 6-Pin Modular Plug</li> <li>• Molded Black; Cord Not included</li> <li>• Compatible with 01-DPORT4</li> </ul>  |             |          |                  |                 |   |         |          |            |
|   | 01-RJ4DATA  |          | -                | -               | - | -       | -        | \$ 156     |
| <b>Description</b> <ul style="list-style-type: none"> <li>• 8-Pin Modular Plug; Cat 5 Ethernet Cable; Pre-terminated Cable</li> <li>• 9' Cord</li> <li>• Compatible with 01-DPORT4</li> </ul>  |             |          |                  |                 |   |         |          |            |

For ordering options, see overview at the beginning of this section.

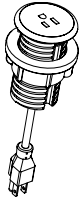
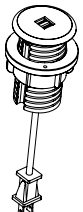
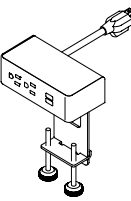
| Item  | Model No.               |        | W               | D               | H | Ship Wt | Cubic Ft | List Price |
|---|-------------------------|--------|-----------------|-----------------|---|---------|----------|------------|
|    | 01-GRMTB                | Black  | 2 $\frac{3}{8}$ | 2 $\frac{3}{8}$ | - | 1       | 0.1      | \$ 33      |
|   | 01-GRMTSL               | Silver | 2 $\frac{3}{8}$ | 2 $\frac{3}{8}$ | - | 1       | 0.1      | \$ 33      |
|   | <i>Open Market Only</i> |        |                 |                 |   |         |          |            |
| <b>Description</b>  |                         |        |                 |                 |   |         |          |            |
| <ul style="list-style-type: none"> <li>• 2<math>\frac{3}{8}</math>" (60mm) Round Grommet Cover</li> <li>• Field Installed</li> </ul>  |                         |        |                 |                 |   |         |          |            |
| <b>Option: Specify</b>  |                         |        |                 |                 |   |         |          |            |
| Factory Installed   |                         |        |                 |                 |   |         |          | \$ 72      |
|    | 01-SAND60PS             | Silver | 3               | 3               | 4 | 1       | 0.2      | \$ 92      |
|   | 01-SAND60PW             | White  | 3               | 3               | 4 | 1       | 0.2      | \$ 92      |
|   | 01-SAND60PB             | Black  | 3               | 3               | 4 | 1       | 0.2      | \$ 92      |
|   | <b>Description</b>      |        |                 |                 |   |         |          |            |
| <ul style="list-style-type: none"> <li>• Mounts in 2<math>\frac{3}{8}</math>" (60mm) Round Grommet</li> <li>• Single Power Outlet with 6' Cord</li> </ul>   |                         |        |                 |                 |   |         |          |            |
|    | 01-SAND60US             | Silver | 3               | 3               | 4 | 1       | 0.2      | \$ 260     |
|   | 01-SAND60UW             | White  | 3               | 3               | 4 | 1       | 0.2      | \$ 260     |
|   | 01-SAND60UB             | Black  | 3               | 3               | 4 | 1       | 0.2      | \$ 260     |
|   | <b>Description</b>      |        |                 |                 |   |         |          |            |
| <ul style="list-style-type: none"> <li>• Mounts in 2<math>\frac{3}{8}</math>" (60mm) Round Grommet</li> <li>• Dual USB Outlets with 6' Cord</li> </ul>  |                         |        |                 |                 |   |         |          |            |
|    | 01-DUOCLAMPS            | Silver | 5 $\frac{1}{2}$ | 3               | 7 | 1       | 0.2      | \$ 537     |
|   | 01-DUOCLAMPW            | White  | 5 $\frac{1}{2}$ | 3               | 7 | 1       | 0.2      | \$ 537     |
|   | 01-DUOCLAMPB            | Black  | 5 $\frac{1}{2}$ | 3               | 7 | 1       | 0.2      | \$ 537     |
|   | <b>Description</b>      |        |                 |                 |   |         |          |            |
| <ul style="list-style-type: none"> <li>• Silver Metal Trim</li> <li>• Clamps to Top</li> <li>• Two (2) Power/Two (2) USB; 10' Cord</li> <li>• Independent USB Circuit Controllers Deliver up to 2.1 Amps to Each Post</li> <li>• All Mounting Hardware Included</li> <li>• FCC Part 15A and UL Approved for Horizontal and Vertical Applications</li> </ul> |                         |        |                 |                 |   |         |          |            |

For ordering options, see overview at the beginning of this section.

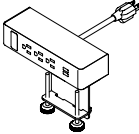
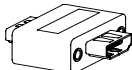
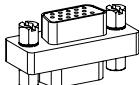
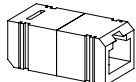
| Item  | Model No.     |        | W | D | H | Ship Wt | Cubic Ft | List Price |
|---|---------------|--------|---|---|---|---------|----------|------------|
| <b>TRIO BEZEL CLAMP<br/>NEMA PLUG</b><br><br>  | 01-TRIOCLAMPS | Silver | 8 | 3 | 7 | 1       | 0.2      | \$ 629     |
|   | 01-TRIOCLAMPW | White  | 8 | 3 | 7 | 1       | 0.2      | \$ 629     |
|   | 01-TRIOCLAMPS | Black  | 8 | 3 | 7 | 1       | 0.2      | \$ 629     |
| <b>Description</b> <ul style="list-style-type: none"> <li>• Silver Metal Trim</li> <li>• Clamps to Top</li> <li>• Three (3) Power/Two (2) USB Power/One (1) Open Data; 10' Cord</li> <li>• Independent USB Circuit Controllers Deliver up to 2.1 Amps to Each Post</li> <li>• HDMI, VGA, or RJ45 Accessories Sold Separately; See Below</li> <li>• All Mounting Hardware Included</li> <li>• FCC Part 15A and UL Approved for Horizontal and Vertical Applications</li> </ul> |               |        |   |   |   |         |          |            |
| <b>HDMI DATA PORT ACCESSORY<br/>FOR TRIO UNITS</b><br><br><br><br>Open Market  | 01-LCOMHDMI   |        | - | - | - | 1       | 0.2      | \$ 155     |
| <b>Description</b> <ul style="list-style-type: none"> <li>• HDMI Port for Trio Bezel Units</li> </ul>   |               |        |   |   |   |         |          |            |
| <b>VGA DATA PORT ACCESSORY<br/>FOR TRIO UNITS</b><br><br>  | 01-LCOMVGA    |        | - | - | - | 1       | 0.2      | \$ 114     |
| <b>Description</b> <ul style="list-style-type: none"> <li>• VGA Port for Trio Bezel Units</li> </ul>  |               |        |   |   |   |         |          |            |
| <b>RJ45 DATA PORT ACCESSORY<br/>FOR TRIO UNITS</b><br><br>   | 01-LCOMRJ45   |        | - | - | - | 1       | 0.2      | \$ 74      |
| <b>Description</b> <ul style="list-style-type: none"> <li>• RJ45 Port for Trio Bezel Units</li> </ul>   |               |        |   |   |   |         |          |            |

For ordering options, see overview at the beginning of this section.



| Item               | Model No. | W                | D  | H                | Ship Wt | Cubic Ft | List Price |
|--------------------|-----------|------------------|----|------------------|---------|----------|------------|
| VESTA POWER CENTER | 01-PDCTR  | 10 $\frac{3}{4}$ | 12 | 28 $\frac{1}{4}$ | 14      | 2.5      | \$ 1666    |



### Description

- Top Includes One (1) Power Outlet, Two (2) USB Ports and One (1) USBC Port; Base Includes Three (3) Outlets
- Available in White
- 120" Power Cord
- Built with Weight Distribution for Optimal Stability
- Base is 5" Tall

### WIRE MANAGERS

|          |    |                 |               |   |   |        |
|----------|----|-----------------|---------------|---|---|--------|
| 01-WMGR4 | 16 | 1 $\frac{1}{2}$ | $\frac{3}{4}$ | 1 | - | \$ 109 |
|----------|----|-----------------|---------------|---|---|--------|

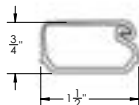

### Description

- Four (4) Wire Manager Strips
- Black Plastic
- Snap Lock Channel
- Attaches with Adhesive Strips
- Can be Placed on All Units to Route Wires

### CABLE GRIP

|           |                 |                 |   |   |   |       |
|-----------|-----------------|-----------------|---|---|---|-------|
| 01-WMGRCB | 5 $\frac{3}{8}$ | 2 $\frac{5}{8}$ | - | - | - | \$ 16 |
|-----------|-----------------|-----------------|---|---|---|-------|

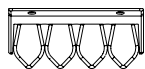

### Description

- Under Surface Wire Management
- Black

### POWER STRIP

|         |   |   |   |   |   |        |
|---------|---|---|---|---|---|--------|
| 01-PRSP | 9 | 2 | 2 | 1 | - | \$ 192 |
|---------|---|---|---|---|---|--------|



### Description

- Includes Four (4) Outlets and Two (2) Phone Jacks
- Black Plastic with Rocker On/Off Switch
- 13 Amp Circuit Breaker
- 10' Power Cord and Two (2) 14' Phone Hook Up Cords
- UL Listed and CSA Certified
- Suitable for Surface or Recessed Mounting
- Ships via UPS Only

For ordering options, see overview at the beginning of this section.

| Item               | Model No.  | Description  | List Price |
|--------------------|--|--|------------|
| ECA TELECOM PLATES | 01-ABL   | Telecom Plate, Blank Plate   | \$ 39      |
|                    | 01-ABL737373   | Telecom Plate, Three (3) RJ45 Cat 5e   | \$ 345     |
|                    | Compatible with:   |  |            |
|                    | 01-ABLAB   | Telecom Plate, One (1) RJ45 Cat 6, One (1) RJ11 Cat 3 Phone  | \$ 193     |
|                    | 01-ABLAB102  | Telecom Plate, One (1) RJ45 Cat 6, One (1) RJ11 Cat 3, One (1) USB W/72" Patch Cord                              | \$ 300     |
|                    | 01-ABLABB  | Telecom Plate, Two (2) RJ45 Cat 6, One (1) RJ11 Cat 3 Phone  | \$ 300     |
|                    | 01-ABLB  | Telecom Plate, One (1) RJ45 Cat 6  | \$ 140     |
|                    | 01-ABLB  | Telecom Plate, Two (2) RJ45 Cat 6  | \$ 244     |
|                    | 01-ABLBBB  | Telecom Plate, Three (3) RJ45 Cat 6  | \$ 345     |
|                    | 01-ABLBBB  | Telecom Plate, Four (4) RJ45 Cat 6   | \$ 447     |
|                    | 01-ABLBBB  | Telecom Plate, Three (3) RJ45 Cat 6  | \$ 345     |
|                    | 01-ABLBBB  | Telecom Plate, Four (4) RJ45 Cat 6   | \$ 447     |
|                    | 01-ABLBBBC51   | Telecom Plate, Two (2) RJ45 Cat 6, One (1) 15 Pin HD VGA w/72" Patch Cord  | \$ 418     |
|                    | 01-ABLBC51L  | Telecom Plate, One (1) RJ45 Cat 6, One (1) Mini Stereo Inline, One (1) 15 Pin HD VGA w/72" Patch Cord            | \$ 384     |
|                    | 01-ABLC3811  | Telecom Plate, One (1) RJ45 Cat 6 Data Inline, One (1) RJ11 Cat 3 Phone Inline                                   | \$ 184     |
|                    | 01-ABLC45  | Telecom Plate, One (1) HDMI w/36" Patch Cord   | \$ 277     |
|                    | 01-ABLC45C51L  | Telecom Plate, One (1) Mini Stereo Inline, One (1) HDMI w/36" Patch Cord, One (1) 15 Pin HD VGA w/72" Patch Cord | \$ 523     |
| 01-ABLC51L         | Telecom Plate, One (1) 15 Pin HD VGA & One (1) Mini Stereo Inline Jack | \$ 280   |            |
| 01-ABLCRDM         | Telecom Plate, Three (3) Cord Bushings                                 | \$ 90  |            |



Oasis Mini Power & Data  
01-OASISMA, 01-OASISMB



Interact Power & Data  
01-INTERACTG2A, 01-INTERACTG2B



Power Center  
01-INTRFCIA, 01-INTRFCIB

For ordering options, see overview at the beginning of this section.

Canvas Table Collection offers a comprehensive selection of shapes and color options for any space that demands versatility and dependability. Select from a range of bases, including our stylish Strut Legs which are designed with precision minimalist lines and angles to establish modern sensibility in any work area.

### CONSTRUCTION

Canvas Work and Circular Tables feature your choice of either a TFL or HPL top. All other tops feature HPL. Non-metal bases feature TFL or Veneer (where noted).

### LAMINATES

- Exposed surfaces are produced from wood grained, patterned, and solid color laminates fused to a particle-board core
- Each laminate offers lasting beauty, superior resistance to normal wear, and easy maintenance

### TOPS

- Work and Circular Tops are 1" thick Thermally-Fused Laminate (TFL) or High Pressure Laminate (HPL) with matching 3mm PVC rims on profiled edges and 1mm PVC rims on self edges
- All other tops feature HPL with 3-ply balanced construction, 1 $\frac{1}{16}$ " thick with PVC rims; Tops are shaped on all four sides
- Grain direction runs width of top, unless otherwise noted

### CHASSIS

- Tops and end panels are securely fastened using high quality European fastening systems to assure maximum strength
- All units are equipped with heavy-duty, adjustable glides to ensure proper leveling and compensation for uneven floors

### DRAWERS

- Drawer fronts are 3-ply construction,  $\frac{3}{4}$ " thick with matched grain
- Drawer sides, back, and front are woodgrain vinyl wrapped,  $\frac{1}{2}$ " thick; Box and file drawers have  $\frac{1}{8}$ " thick hardboard bottoms
- 5-sided drawer construction for easy removal of drawer fronts
- All drawers feature full extension, progressive action slides with precision steel ball bearings
- Box and file drawers are tested for 100lb capacity
- Lateral files are tested for 200lb capacity
- All suspensions have a limited lifetime warranty

### STORAGE

- All hinged doors include soft close hinges, unless otherwise noted
- One piece hinge and base plate combination
- Soft close hinges reduce stress placed on the cabinet when the door is closed and offers a quiet closure

### LOCKING

- All units with file drawers feature locking
- Removable lock cylinders allow for units to be re-keyed at a later date if required
- Units are shipped randomly keyed as standard. Keyed alike units available upon request at no additional charge.
- Keyed alike units available upon request at no additional charge
- Lock cores match pull color

### INTERIOR DRAWER DIMENSIONS

#### Models

94-2472BFD 94-2436SV

#### Drawers

|     | W                    | L                  | D                   |
|-----|----------------------|--------------------|---------------------|
| Box | 14 $\frac{17}{32}$ " | 19 $\frac{1}{4}$ " | 3 $\frac{21}{32}$ " |

#### Models

94-2436BF 94-2472BF

#### Drawers

|     | W                   | L                  | D                   |
|-----|---------------------|--------------------|---------------------|
| Box | 32 $\frac{9}{16}$ " | 19 $\frac{1}{4}$ " | 3 $\frac{21}{32}$ " |

#### Models

94-2472SBF

#### Drawers

|     | W                    | L                  | D                   |
|-----|----------------------|--------------------|---------------------|
| Box | 14 $\frac{17}{32}$ " | 19 $\frac{1}{4}$ " | 3 $\frac{21}{32}$ " |
| Box | 32 $\frac{9}{16}$ "  | 19 $\frac{1}{4}$ " | 3 $\frac{21}{32}$ " |

### HOW TO ORDER EXAMPLES

|                     | QTY | MODEL NO.      | DESCRIPTION                     | EXAMPLE                |
|---------------------|-----|----------------|---------------------------------|------------------------|
| <b>TOP</b>          | 1   | 94-48120AT     | Color                           | BW                     |
|                     |     |                | Edge Profile                    | G                      |
|                     |     |                | Grommet/Power/<br>Data Location | ELR                    |
|                     |     |                |                                 |                        |
| <b>BASES</b>        | 3   | 01-0427FPB     | Color                           | BW                     |
|                     |     |                | Metal Finish                    | OYST                   |
| <b>PORTS</b>        | 2   | 01-INTERACTG2B |                                 |                        |
| <b>STORAGE</b>      | 1   | 94-3672SUD     | Color                           | BW                     |
|                     |     |                | Pull                            | AEL                    |
| <b>VISUAL BOARD</b> | 1   | 94-4848VB      | Color                           | BW                     |
|                     |     |                | Pull                            | AEL                    |
|                     |     |                | Tackboard/<br>Upholstery        | Momentum<br>Jot Fossil |
|                     |     |                | Projection Screen               | 1-PS                   |

### HPL (P) LAMINATE OPTIONS

#### WOODGRAIN

|     |                  |     |                     |
|-----|------------------|-----|---------------------|
| AS  | Asian Night      | PNW | Pinnacle Walnut     |
| BW  | Beigewood        | SCH | Select Cherry       |
| CO  | Columbian Walnut | SKC | Shaker Cherry       |
| EF  | Espresso         | SBP | Smoky Brown Pear    |
| GC  | Golden Cherry    | TK  | Studio Teak         |
| HVM | Harvest Maple    | SM  | Sugar Maple         |
| MW  | Mahogany Walnut  | WTA | Weathered Ash       |
| ORW | Oak Riftwood     | WC  | Williamsburg Cherry |

#### SOLID

|     |                |     |             |
|-----|----------------|-----|-------------|
| BL  | Black          | PPD | Pepperdust* |
| WH  | Designer White | SG  | Slate Grey* |
| FHG | Fashion Grey*  | WHS | White Sand* |

\*Not Available on Cylinder or Canoe Bases.

### VENEER (W) OPTIONS AVAILABLE ON SELECT BASES

Veneer features UVAdvantage, an ultra-violet finish, on all exposed surfaces by utilizing roll-coat UV technology

|     |                    |     |                     |
|-----|--------------------|-----|---------------------|
| AW  | Artisan Walnut     | MW  | Mahogany Walnut     |
| AS  | Asian Night        | MO  | Medium Oak*         |
| CO  | Columbian Walnut   | ORW | Oak Riftwood*       |
| DC  | Dark Cherry        | SCH | Select Cherry       |
| DFW | Dark Forest Walnut | SKC | Shaker Cherry       |
| EW  | Espresso           | SBP | Smoky Brown Pear    |
| FO  | Fawn Oak*          | SM  | Sugar Maple         |
| GC  | Golden Cherry      | SW  | Sunglow Walnut      |
| HVM | Harvest Maple      | WTA | Weathered Ash*      |
| HW  | Harvest Walnut     | WC  | Williamsburg Cherry |
| LW  | Legacy Walnut      |     |                     |

\*Finish is Low Sheen

### EDGE PROFILES

|   |             |   |        |
|---|-------------|---|--------|
| F | Double Kerf | X | Flute  |
| G | Duo         | Y | Square |



### METAL FINISH OPTIONS

|      |          |      |              |
|------|----------|------|--------------|
| ALUM | Aluminum | OYST | Oyster White |
| MIST | Mist     | SUGC | Sugar Cookie |
| NOIR | Noir     |      |              |

### GROMMET/POWER/DATA OPTIONS & LOCATIONS

[See Multiple Top Shapes and Sizes](#) and [See Locations for Power/Data Options](#)

Work Table Grommet and Power Options and Locations below:

|            |            |            |
|------------|------------|------------|
| 66-4896WT  | 66-4860CWT | 66-4260TWT |
| 66-4896TWT | 66-4296WT  | 66-4260CWT |
| 66-4896CWT | 66-4296TWT | 66-3696TWT |
| 66-4884WT  | 66-4296CWT | 66-3696CWT |
| 66-4884TWT | 66-4284WT  | 66-3684TWT |
| 66-4884CWT | 66-4284TWT | 66-3684CWT |
| 66-4872WT  | 66-4284CWT | 66-3672TWT |
| 66-4872TWT | 66-4272WT  | 66-3672CWT |
| 66-4872CWT | 66-4272TWT | 66-3660TWT |
| 66-4860WT  | 66-4272CWT | 66-3660CWT |
| 66-4860TWT | 66-4260WT  |            |

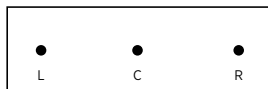

#### 48" Work Tables

GL/GR/PDC-L/PDC-R/DOCK950-L/DOCK950-R/DOCK150-L/DOCK150-R: Located 6" from ends and 24" from user  
GC/PDC-C/DOCK950-C/DOCK150-C: Located 24" from user

#### 42" Work Tables

GL/GR/PDC-L/PDC-R/DOCK950-L/DOCK950-R/DOCK150-L/DOCK150-R: Located 6" from ends and 21" from user  
GC/PDC-C/DOCK950-C/DOCK150-C: Located 21" from user

#### 36" Work Tables

GL/GR/PDC-L/PDC-R/DOCK950-L/DOCK950-R/DOCK150-L/DOCK150-R: Located 6" from ends and 18" from user  
GC/PDC-C/DOCK950-C/DOCK150-C: Located 18" from user

### PULL OPTIONS

Note: Lock Core will match Pull Color

|     |                   |     |                  |
|-----|-------------------|-----|------------------|
| AAV | Alcove, Aluminum  | BEL | Elite, Black     |
| CAV | Alcove, Chrome    | AFL | Flair, Aluminum  |
| AAC | Arc, Aluminum     | CFL | Flair, Chrome    |
| BAC | Arc, Black        | AFC | Focus, Aluminum  |
| ABM | Beam, Aluminum    | BFC | Focus, Black     |
| BBM | Beam, Black       | AQD | Quadra, Aluminum |
| ABT | Bow Tie, Aluminum | BQD | Quadra, Black    |
| NBT | Bow Tie, Nickel   | AST | Studio, Aluminum |
| ABU | Buckle, Aluminum  | BST | Studio, Black    |
| BBU | Buckle, Black     | CST | Studio, Chrome   |
| AEL | Elite, Aluminum   |     |                  |

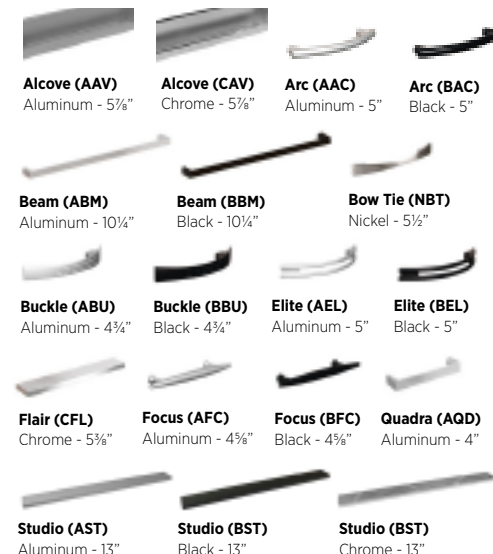

### DRAWER OPTIONS

Units with drawers come standard with woodgrain vinyl-wrapped drawers. Optional wood dove tail construction for all box, file, and lateral file drawers is available. Soft close is also available for all box drawers. Must specify when ordering.

Pricing is per Drawer, not per Model/Unit.

|       |   |    |    |
|-------|---|----|----|
| DOVE  | Wood Dove Tail Construction                       | \$ | 42 |
| SFTCL | Soft Close Drawer Track (Box & File Drawers Only) | \$ | 32 |

### LOCKING DOORS

Locking doors are available on specific units, where noted. You must specify WITH LOCKING when ordering and add upcharge.

|        |                    |    |     |
|--------|--------------------|----|-----|
| LKT_HU | 72"W to 48"W Units | \$ | 108 |
| LKT_HU | 42"W to 30"W Units | \$ | 85  |
| LKT_HU | 18"W Units         | \$ | 65  |

### CERTIFICATIONS & COMPLIANCE

- Intertek Sustainability Certified
- BIFMA level® Certified
- BIFMA Compliant® Certified
- TSCA Title VI (formerly CARB) Compliance
- US Green Building's LEED® Contribution

**Work Tables**

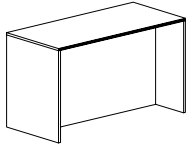

Standing Height [\(See Details\)](#)

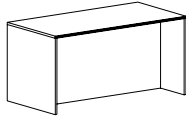

Counter Height [\(See Details\)](#)

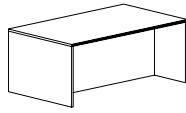

Seated Height [\(See Details\)](#)

**Tops/Shapes**

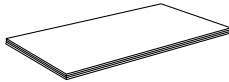

Rectangular [\(See Details\)](#)



Arc Rectangular [\(See Details\)](#)

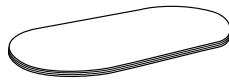

Racetrack [\(See Details\)](#)



Boat-Shaped [\(See Details\)](#)



Circular [\(See Details\)](#)

**Bases**

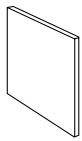

Rectangular Panel [\(See Details\)](#)

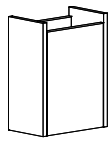

Rectangular with Door [\(See Details\)](#)

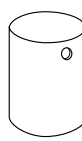

Cylinder [\(See Details\)](#)

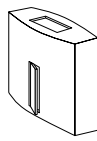

Canoe [\(See Details\)](#)

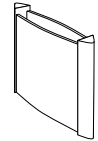

V-Capped Panel [\(See Details\)](#)

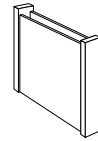

Flat-Capped Panel [\(See Details\)](#)



Metal [\(See Details\)](#)



Strut [\(See Details\)](#)

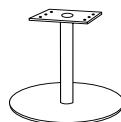

Disc Base [\(See Details\)](#)



Height Adjustable Base [\(See Details\)](#)

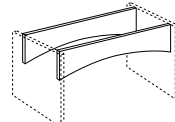

Arch Stretcher Rails [\(See Details\)](#)

**Storage Components**

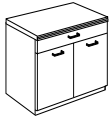

Two Door Buffet w/Drawer [\(See Details\)](#)

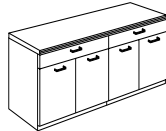

Four Door Buffet w/2 Drawers [\(See Details\)](#)

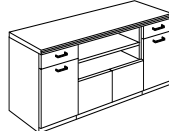

Four Door Buffet w/2 Drawers & Open Storage [\(See Details\)](#)

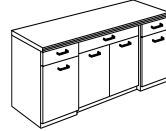

Four Door Buffet w/3 Drawers [\(See Details\)](#)

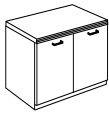

Two Door Credenza [\(See Details\)](#)

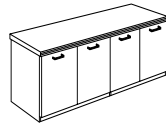

Four Door Credenza [\(See Details\)](#)

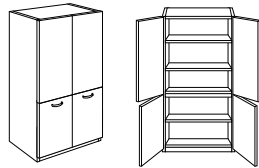

Storage Cabinet Double Doors [\(See Details\)](#)

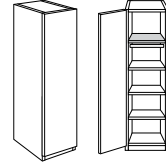

Wardrobe/Storage Cabinet [\(See Details\)](#)



Mobile Serving Cart [\(See Details\)](#)



Lectern Stand [\(See Details\)](#)

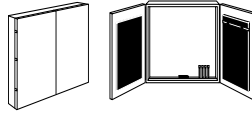

Visual Board [\(See Details\)](#)

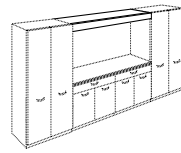

Visor Rail [\(See Details\)](#)

**Wire Management & Power/Data Accessories [\(See Multiple Unit Details\)](#)**

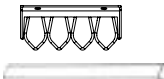

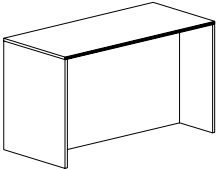
| Item   | Model No.                                       | W  | D  | H  | Ship Wt | Cubic Ft | List Price   |
|--|---|----|----|----|---------|----------|--|
| <b>WORK TABLE</b><br><b>STANDING HEIGHT</b><br> | <b>48"D Units</b>                               |    |    |    |         |          |  |
|  | 66-4896TWT                                      | 96 | 48 | 42 | 402     | 14.2     | T\$ 2403<br>P\$ 2828<br><i>Wire Management Option Upcharge:</i> \$ 471 |
|  | 66-4884TWT                                      | 84 | 48 | 42 | 368     | 12.4     | T\$ 2242<br>P\$ 2628<br><i>Wire Management Option Upcharge:</i> \$ 426 |
|  | 66-4872TWT                                      | 72 | 48 | 42 | 332     | 10.7     | T\$ 2086<br>P\$ 2448<br><i>Wire Management Option Upcharge:</i> \$ 378 |
|  | 66-4860TWT                                      | 60 | 48 | 42 | 300     | 9.0      | T\$ 1928<br>P\$ 2258<br><i>Wire Management Option Upcharge:</i> \$ 335 |
|  | <b>42"D Units</b>                               |    |    |    |         |          |  |
|  | 66-4296TWT                                      | 96 | 42 | 42 | 374     | 12.5     | T\$ 2168<br>P\$ 2553<br><i>Wire Management Option Upcharge:</i> \$ 471 |
|  | 66-4284TWT                                      | 84 | 42 | 42 | 342     | 10.9     | T\$ 2033<br>P\$ 2377<br><i>Wire Management Option Upcharge:</i> \$ 426 |
|  | 66-4272TWT                                      | 72 | 42 | 42 | 308     | 9.4      | T\$ 1897<br>P\$ 2225<br><i>Wire Management Option Upcharge:</i> \$ 378 |
|  | 66-4260TWT                                      | 60 | 42 | 42 | 278     | 7.9      | T\$ 1765<br>P\$ 2062<br><i>Wire Management Option Upcharge:</i> \$ 335 |
|  | <b>36"D Units</b>                               |    |    |    |         |          |  |
|  | 66-3696TWT                                      | 96 | 36 | 42 | 346     | 10.8     | T\$ 2045<br>P\$ 2388<br><i>Wire Management Option Upcharge:</i> \$ 471 |
|  | 66-3684TWT                                      | 84 | 36 | 42 | 315     | 9.5      | T\$ 1921<br>P\$ 2226<br><i>Wire Management Option Upcharge:</i> \$ 426 |
|  | 66-3672TWT                                      | 72 | 36 | 42 | 283     | 8.1      | T\$ 1795<br>P\$ 2083<br><i>Wire Management Option Upcharge:</i> \$ 378 |
|  | 66-3660TWT                                      | 60 | 36 | 42 | 255     | 6.8      | T\$ 1671<br>P\$ 1935<br><i>Wire Management Option Upcharge:</i> \$ 335 |
|  | <b>24"D Units—Suggested Use is Against Wall</b> |    |    |    |         |          |  |
|  | 66-2496TWT<br><i>Modesty Recessed 5/4"</i>      | 96 | 24 | 42 | 211     | 64.9     | T\$ 1830<br>P\$ 2113   |
|  | 66-2484TWT<br><i>Modesty Recessed 5/4"</i>      | 84 | 24 | 42 | 193     | 57.0     | T\$ 1723<br>P\$ 1978   |
|  | 66-2472TWT<br><i>Modesty Recessed 5/4"</i>      | 72 | 24 | 42 | 176     | 49.0     | T\$ 1616<br>P\$ 1852   |
|  | 66-2460TWT<br><i>Modesty Recessed 5/4"</i>      | 60 | 24 | 42 | 158     | 41.1     | T\$ 1507<br>P\$ 1728   |

Must Specify (in this order):

- Model #
- Top Material
- Color
- Edge Profile
- Chassis Color
- Modesty Color
- Grommet/Power/Data Location

**Description**

- Centered Modesty Available in Contrasting Colors
- Optional Grommets, Dock 950 Wireless Chargers, Dock 150 Wireless and USB Chargers or Power/Data Ports, [See Power Unit Options](#) and [See Locations](#)
- Double Modesty/Wire Management Upcharge will be Included when Grommet, Dock Wireless and USB Chargers, or Power/Data Ports are Ordered
- Duo/Trio and Power Data Port Units (01-DPORT4A/B) Available in PDC Locations, [See PDC Locations](#)
- 24" Deep Units Are Meant to be Used Against a Wall; Modesty Panel is Recessed 5/4"
- Ships KD; Some Assembly Required

T = TFL P = HPL

[See Canvas Overview For Ordering Options](#)

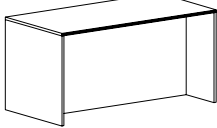
| Item   | Model No.                                       | W  | D  | H  | Ship Wt | Cubic Ft | List Price   |
|--|---|----|----|----|---------|----------|--|
| <b>WORK TABLE</b><br><b>STANDING HEIGHT</b><br> | <b>48"D Units</b>                               |    |    |    |         |          |  |
|  | 66-4896CWT                                      | 96 | 48 | 42 | 402     | 14.2     | T\$ 2293<br>P\$ 2721<br><i>Wire Management Option Upcharge:</i> \$ 471 |
|  | 66-4884CWT                                      | 84 | 48 | 42 | 368     | 12.4     | T\$ 2143<br>P\$ 2527<br><i>Wire Management Option Upcharge:</i> \$ 391 |
|  | 66-4872CWT                                      | 72 | 48 | 42 | 332     | 10.7     | T\$ 1991<br>P\$ 2354<br><i>Wire Management Option Upcharge:</i> \$ 350 |
|  | 66-4860CWT                                      | 60 | 48 | 42 | 300     | 9.0      | T\$ 1839<br>P\$ 2171<br><i>Wire Management Option Upcharge:</i> \$ 306 |
|  | <b>42"D Units</b>                               |    |    |    |         |          |  |
|  | 66-4296CWT                                      | 96 | 42 | 42 | 374     | 12.5     | T\$ 2069<br>P\$ 2450<br><i>Wire Management Option Upcharge:</i> \$ 471 |
|  | 66-4284CWT                                      | 84 | 42 | 42 | 342     | 10.9     | T\$ 1941<br>P\$ 2285<br><i>Wire Management Option Upcharge:</i> \$ 391 |
|  | 66-4272CWT                                      | 72 | 42 | 42 | 308     | 9.4      | T\$ 1813<br>P\$ 2137<br><i>Wire Management Option Upcharge:</i> \$ 350 |
|  | 66-4260CWT                                      | 60 | 42 | 42 | 278     | 7.9      | T\$ 1683<br>P\$ 1981<br><i>Wire Management Option Upcharge:</i> \$ 306 |
|  | <b>36"D Units</b>                               |    |    |    |         |          |  |
|  | 66-3696CWT                                      | 96 | 36 | 42 | 346     | 10.8     | T\$ 1936<br>P\$ 2280<br><i>Wire Management Option Upcharge:</i> \$ 471 |
|  | 66-3684CWT                                      | 84 | 36 | 42 | 315     | 9.5      | T\$ 1820<br>P\$ 2124<br><i>Wire Management Option Upcharge:</i> \$ 391 |
|  | 66-3672CWT                                      | 72 | 36 | 42 | 283     | 8.1      | T\$ 1700<br>P\$ 1989<br><i>Wire Management Option Upcharge:</i> \$ 350 |
|  | 66-3660CWT                                      | 60 | 36 | 42 | 255     | 6.8      | T\$ 1582<br>P\$ 1848<br><i>Wire Management Option Upcharge:</i> \$ 306 |
|  | <b>24"D Units—Suggested Use is Against Wall</b> |    |    |    |         |          |  |
|  | 66-2496CWT<br><i>Modesty Recessed 5¼"</i>       | 96 | 24 | 42 | 211     | 64.9     | T\$ 1677<br>P\$ 1958   |
|  | 66-2484CWT<br><i>Modesty Recessed 5¼"</i>       | 84 | 24 | 42 | 193     | 57.0     | T\$ 1577<br>P\$ 1831   |
|  | 66-2472CWT<br><i>Modesty Recessed 5¼"</i>       | 72 | 24 | 42 | 176     | 49.0     | T\$ 1478<br>P\$ 1716   |
|  | 66-2460CWT<br><i>Modesty Recessed 5¼"</i>       | 60 | 24 | 42 | 158     | 41.1     | T\$ 1381<br>P\$ 1603   |

**Must Specify (in this order):**

Model #  
 Top Material  
 Color  
 Edge Profile  
 Chassis Color  
 Modesty Color  
 Grommet/Power/Data Location

**Description**

- Centered Modesty Available in Contrasting Colors
- Optional Grommets, Dock 950 Wireless Chargers, Dock 150 Wireless and USB Chargers or Power/Data Ports, [See Power Unit Options](#) and [See Locations](#)
- Double Modesty/Wire Management Upcharge will be Included when Grommet, Dock Wireless and USB Chargers, or Power/Data Ports are Ordered
- Duo/Trio and Power Data Port Units (01-DPORT4A/B) Available in PDC Locations, [See PDC Locations](#)
- 24" Deep Units Are Meant to be Used Against a Wall; Modesty Panel is Recessed 5¼"
- Ships KD; Some Assembly Required

T = TFL P = HPL

[See Canvas Overview For Ordering Options](#)

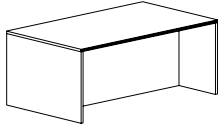
| Item   | Model No.                                       | W  | D  | H  | Ship Wt | Cubic Ft | List Price   |
|--|---|----|----|----|---------|----------|--|
| <b>WORK TABLE</b><br><b>SEATED HEIGHT</b><br> | <b>48"D Units</b>                               |    |    |    |         |          |  |
|  | 66-4896WT                                       | 96 | 48 | 30 | 326     | 14.2     | T\$ 2219<br>P\$ 2644<br><i>Wire Management Option Upcharge:</i> \$ 391 |
|  | 66-4884WT                                       | 84 | 48 | 30 | 298     | 12.4     | T\$ 2071<br>P\$ 2451<br><i>Wire Management Option Upcharge:</i> \$ 357 |
|  | 66-4872WT                                       | 72 | 48 | 30 | 268     | 10.7     | T\$ 1924<br>P\$ 2287<br><i>Wire Management Option Upcharge:</i> \$ 318 |
|  | 66-4860WT                                       | 60 | 48 | 30 | 242     | 9.0      | T\$ 1778<br>P\$ 2108<br><i>Wire Management Option Upcharge:</i> \$ 280 |
|  | <b>42"D Units</b>                               |    |    |    |         |          |  |
|  | 66-4296WT                                       | 96 | 42 | 30 | 374     | 12.5     | T\$ 1964<br>P\$ 2348<br><i>Wire Management Option Upcharge:</i> \$ 391 |
|  | 66-4284WT                                       | 84 | 42 | 30 | 342     | 10.9     | T\$ 1845<br>P\$ 2188<br><i>Wire Management Option Upcharge:</i> \$ 357 |
|  | 66-4272WT                                       | 72 | 42 | 30 | 308     | 9.4      | T\$ 1719<br>P\$ 2045<br><i>Wire Management Option Upcharge:</i> \$ 318 |
|  | 66-4260WT                                       | 60 | 42 | 30 | 278     | 7.9      | T\$ 1599<br>P\$ 1896<br><i>Wire Management Option Upcharge:</i> \$ 280 |
|  | <b>24"D Units—Suggested Use is Against Wall</b> |    |    |    |         |          |  |
|  | 66-2496WT<br><i>Modesty Recessed 5/4"</i>       | 96 | 24 | 30 | 173     | 47.2     | T\$ 1545<br>P\$ 1829   |
|  | 66-2484WT<br><i>Modesty Recessed 5/4"</i>       | 84 | 24 | 30 | 158     | 41.4     | T\$ 1458<br>P\$ 1710   |
|  | 66-2472WT<br><i>Modesty Recessed 5/4"</i>       | 72 | 24 | 30 | 143     | 35.6     | T\$ 1365<br>P\$ 1605   |
|  | 66-2460WT<br><i>Modesty Recessed 5/4"</i>       | 60 | 24 | 30 | 129     | 29.8     | T\$ 1276<br>P\$ 1496   |

Must Specify (in this order):

Model #  
 Top Material  
 Color  
 Edge Profile  
 Chassis Color  
 Modesty Color  
 Grommet/Power/Data Location

**Description**

- Centered Modesty Available in Contrasting Colors
- Optional Grommets, Dock 950 Wireless Chargers, Dock 150 Wireless and USB Chargers or Power/Data Ports, [See Power Unit Options](#) and [See Locations](#)
- Double Modesty/Wire Management Upcharge will be Included when Grommet, Dock Wireless and USB Chargers or Power/Data Ports are Ordered
- Duo/Trio and Power Data Port Units (01-DPORT4A/B) Available in PDC Locations, [See PDC Locations](#)
- 24" Deep Units Are Meant to be Used Against a Wall; Modesty Panel is Recessed 5/4"
- Ships KD; Some Assembly Required

T = TFL P = HPL

[See Canvas Overview For Ordering Options](#)

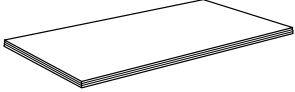

| Item  | Model No.                         | W   | D  | H                | Ship Wt | Cubic Ft | List Price |
|---|-----------------------------------|-----|----|------------------|---------|----------|------------|
|  | <b>192" or 16' - 2 Piece Tops</b> |     |    |                  |         |          |            |
|   | 94-48192RT                        | 192 | 48 | 1 $\frac{1}{16}$ | 375     | 15.5     | P\$ 4840   |
|   | <b>168" or 14' - 2 Piece Tops</b> |     |    |                  |         |          |            |
|   | 94-48168RT                        | 168 | 48 | 1 $\frac{1}{16}$ | 325     | 13.6     | P\$ 4188   |
|   | <b>144" or 12' - 2 Piece Tops</b> |     |    |                  |         |          |            |
|   | 94-48144RT                        | 144 | 48 | 1 $\frac{1}{16}$ | 275     | 12.3     | P\$ 3403   |
|   | <b>120" or 10' - 2 Piece Tops</b> |     |    |                  |         |          |            |
|   | 94-48120RT                        | 120 | 48 | 1 $\frac{1}{16}$ | 225     | 10.3     | P\$ 3069   |
|   | <b>96" or 8' - 1 Piece Top</b>    |     |    |                  |         |          |            |
|   | 94-4296RT                         | 96  | 42 | 1 $\frac{1}{16}$ | 180     | 9.4      | P\$ 2331   |
| <b>72" or 6' - 1 Piece Top</b>  |                                   |     |    |                  |         |          |            |
|   | 94-3672RT                         | 72  | 36 | 1 $\frac{1}{16}$ | 100     | 6.2      | P\$ 1572   |

Must Specify (in this order):

Model #  
Color  
Edge Profile  
Grommet/Power/Data Location

**Description**

- Grain Runs the Width of the Table
- Heavy-Duty Ganging Mechanisms Connect Two (2) Piece Tops
- See Bases/Legs and Number Required For Each Top Size, [See Multiple Base Options](#); Must Order Separately
- When Using with Strut Legs, We Recommend Using Two (2) Stiffener Bars on Tops 96"W and Four (4) Stiffener Bars on Tops 144"W and Wider; Must Order Separately, [See Strut Details](#)
- Tops 120"W Do Not Need Stretcher Rails When Used with Strut Legs, the Location and Number of Strut Legs Required Offer Sufficient Support
- Optional Grommets and Power/Data Units; [See Location Options](#), [See Power Units Available](#)

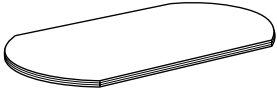
| Item  | Model No.                         | W   | D  | H                | Ship Wt | Cubic Ft | List Price |
|---|-----------------------------------|-----|----|------------------|---------|----------|------------|
|  | <b>192" or 16' - 2 Piece Tops</b> |     |    |                  |         |          |            |
|   | 94-48192AR                        | 192 | 48 | 1 $\frac{1}{16}$ | 375     | 15.5     | P\$ 5617   |
|   | <b>168" or 14' - 2 Piece Tops</b> |     |    |                  |         |          |            |
|   | 94-48168AR                        | 168 | 48 | 1 $\frac{1}{16}$ | 325     | 13.6     | P\$ 4851   |
|   | <b>144" or 12' - 2 Piece Tops</b> |     |    |                  |         |          |            |
|   | 94-48144AR                        | 144 | 48 | 1 $\frac{1}{16}$ | 275     | 12.3     | P\$ 4098   |
|   | <b>120" or 10' - 2 Piece Tops</b> |     |    |                  |         |          |            |
|   | 94-48120AR                        | 120 | 48 | 1 $\frac{1}{16}$ | 225     | 10.3     | P\$ 3826   |
|   | <b>96" or 8' - 1 Piece Top</b>    |     |    |                  |         |          |            |
|   | 94-4296AR                         | 96  | 42 | 1 $\frac{1}{16}$ | 180     | 9.4      | P\$ 2479   |
| <b>72" or 6' - 1 Piece Top</b>  |                                   |     |    |                  |         |          |            |
|   | 94-3672AR                         | 72  | 36 | 1 $\frac{1}{16}$ | 100     | 6.2      | P\$ 2186   |

Must Specify (in this order):

Model #  
Color  
Edge Profile  
Grommet/Power/Data Location

**Description**

- Grain Runs the Width of the Table
- Heavy-Duty Ganging Mechanisms Connect Two (2) Piece Tops
- See Bases/Legs and Number Required For Each Top Size, [See Multiple Base Options](#); Must Order Separately
- When Using with Strut Legs, We Recommend Using Two (2) Stiffener Bars on Tops 96"W and Four (4) Stiffener Bars on Tops 144"W and Wider; Must Order Separately, [See Strut Details](#)
- Tops 120"W Do Not Need Stretcher Rails When Used with Strut Legs, the Location and Number of Strut Legs Required Offer Sufficient Support
- Optional Grommets and Power/Data Units; [See Location Options](#), [See Power Units Available](#)

T = TFL P = HPL

[See Canvas Overview For Ordering Options](#)

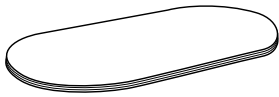
| Item  | Model No.                         | W   | D                | H                | Ship Wt | Cubic Ft | List Price |
|---|-----------------------------------|-----|------------------|------------------|---------|----------|------------|
| <b>RACETRACK TOP</b><br> | <b>192" or 16' - 2 Piece Tops</b> |     |                  |                  |         |          |            |
|   | 94-48192AT                        | 192 | 48               | 1 $\frac{3}{16}$ | 375     | 15.5     | P\$ 5617   |
|   | <b>168" or 14' - 2 Piece Tops</b> |     |                  |                  |         |          |            |
|   | 94-48168AT                        | 168 | 48               | 1 $\frac{3}{16}$ | 325     | 13.6     | P\$ 4851   |
|   | <b>144" or 12' - 2 Piece Tops</b> |     |                  |                  |         |          |            |
|   | 94-48144AT                        | 144 | 48               | 1 $\frac{3}{16}$ | 275     | 12.3     | P\$ 4098   |
|   | <b>120" or 10' - 2 Piece Tops</b> |     |                  |                  |         |          |            |
|   | 94-48120AT                        | 120 | 48               | 1 $\frac{3}{16}$ | 225     | 10.3     | P\$ 3826   |
|   | <b>96" or 8' - 1 Piece Top</b>    |     |                  |                  |         |          |            |
|   | 94-4296AT                         | 96  | 42               | 1 $\frac{3}{16}$ | 180     | 9.4      | P\$ 2479   |
| <b>72" or 6' - 1 Piece Top</b>  |                                   |     |                  |                  |         |          |            |
| 94-3672AT   | 72                                | 36  | 1 $\frac{3}{16}$ | 100              | 6.2     | P\$ 2186 |            |

**Must Specify (in this order):**

Model #  
 Color  
 Edge Profile  
 Grommet/Power/Data Location

**Description**

- Grain Runs the Width of the Table
- Heavy-Duty Ganging Mechanisms Connect Two (2) Piece Tops
- See Bases/Legs and Number Required For Each Top Size, [See Multiple Base Options](#); Must Order Separately
- When Using with Strut Legs, We Recommend Using Two (2) Stiffener Bars on Tops 96"W and Four (4) Stiffener Bars on Tops 144"W and Wider; Must Order Separately, [See Strut Details](#)
- Tops 120"W Do Not Need Stretcher Rails When Used with Strut Legs, the Location and Number of Strut Legs Required Offer Sufficient Support
- Optional Grommets and Power/Data Units; [See Location Options](#), [See Power Units Available](#)

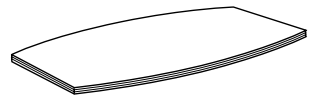
|   |                                   |     |                  |                  |     |          |          |
|---|-----------------------------------|-----|------------------|------------------|-----|----------|----------|
| <b>BOAT-SHAPED TOP</b><br> | <b>192" or 16' - 2 Piece Tops</b> |     |                  |                  |     |          |          |
|   | 94-48192BT                        | 192 | 48               | 1 $\frac{3}{16}$ | 375 | 15.5     | P\$ 5617 |
|   | <b>168" or 14' - 2 Piece Tops</b> |     |                  |                  |     |          |          |
|   | 94-48168BT                        | 168 | 48               | 1 $\frac{3}{16}$ | 325 | 13.6     | P\$ 4851 |
|   | <b>144" or 12' - 2 Piece Tops</b> |     |                  |                  |     |          |          |
|   | 94-48144BT                        | 144 | 48               | 1 $\frac{3}{16}$ | 275 | 12.3     | P\$ 4098 |
|   | <b>120" or 10' - 2 Piece Tops</b> |     |                  |                  |     |          |          |
|   | 94-48120BT                        | 120 | 48               | 1 $\frac{3}{16}$ | 225 | 10.3     | P\$ 3826 |
|   | <b>96" or 8' - 1 Piece Top</b>    |     |                  |                  |     |          |          |
|   | 94-4296BT                         | 96  | 42               | 1 $\frac{3}{16}$ | 180 | 9.4      | P\$ 2479 |
| <b>72" or 6' - 1 Piece Top</b>  |                                   |     |                  |                  |     |          |          |
| 94-3672BT   | 72                                | 36  | 1 $\frac{3}{16}$ | 100              | 6.2 | P\$ 2186 |          |

**Must Specify (in this order):**

Model #  
 Color  
 Edge Profile  
 Grommet/Power/Data Location

**Description**

- Grain Runs the Width of the Table
- Heavy Duty Ganging Mechanisms Connect Two (2) Piece Tops
- See Bases/Legs and Number Required For Each Top Size, [See Multiple Base Options](#); Must Order Separately
- When Using with Strut Legs, We Recommend Using Two (2) Stiffener Bars on Tops 96"W and Four (4) Stiffener Bars on Tops 144"W and Wider; Must Order Separately, [See Strut Details](#)
- Tops 120"W Do Not Need Stretcher Rails When Used with Strut Legs, the Location and Number of Strut Legs Required Offer Sufficient Support
- Optional Grommets and Power/Data Units; [See Location Options](#), [See Power Units Available](#)

T = TFL P = HPL

[See Canvas Overview For Ordering Options](#)

| Item  | Model No.   | W  | D  | H | Ship Wt | Cubic Ft | List Price          |
|---|---|----|----|---|---------|----------|---------------------|
|  | 66-4848CT<br><i>Accommodates Five (5) Chairs</i>  | 48 | 48 | 1 | 95      | 4.3      | T\$ 733<br>P\$ 1027 |
|   | 66-4242CT<br><i>Accommodates Four (4) Chairs</i>  | 42 | 42 | 1 | 70      | 3.4      | T\$ 710<br>P\$ 990  |
|   | 66-3636CT<br><i>Accommodates Three (3) Chairs</i> | 36 | 36 | 1 | 37      | 2.5      | T\$ 620<br>P\$ 870  |

Must Specify (in this order):

Model #  
Top Material  
Color  
Edge Profile

#### Description

- Single Base or Four (4) Strut Legs (on 48" Top Only) Required; Ordered Separately, [See Below and Other Multiple Base Options](#)
- Power Options not Available

#### DISC BASE



| For 48" Circular Tops         |          |  | W  | D  | H                | Ship Wt | Cubic Ft | List Price |
|-------------------------------|----------|--|----|----|------------------|---------|----------|------------|
| 01-3230DBB                    | Black    |  | 30 | 30 | 27 $\frac{3}{4}$ | 42      | 4.1      | \$ 1728    |
| 01-3230DBA                    | Aluminum |  | 30 | 30 | 27 $\frac{3}{4}$ | 42      | 4.1      | \$ 1728    |
| For 36" and 42" Circular Tops |          |  | W  | D  | H                | Ship Wt | Cubic Ft | List Price |
| 01-2430DBB                    | Black    |  | 24 | 24 | 27 $\frac{3}{4}$ | 32      | 3.2      | \$ 1440    |
| 01-2430DBA                    | Aluminum |  | 24 | 24 | 27 $\frac{3}{4}$ | 32      | 3.2      | \$ 1440    |

#### Description

- 4" Diameter Column

#### METAL X-BASE

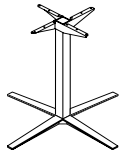

| For 42" and 48" Circular Tops |          |                            | W                | D                | H  | Ship Wt | Cubic Ft | List Price |
|-------------------------------|----------|----------------------------|------------------|------------------|----|---------|----------|------------|
| 08-2642LXB                    | Aluminum |                            | 35 $\frac{1}{2}$ | 35 $\frac{1}{2}$ | 40 | 33      | 20.0     | \$ 1240    |
|                               |          | <i>For 42" High Tables</i> |                  |                  |    |         |          |            |
| 08-2636LXB                    | Aluminum |                            | 35 $\frac{1}{2}$ | 35 $\frac{1}{2}$ | 34 | 30      | 17.2     | \$ 1196    |
|                               |          | <i>For 36" High Tables</i> |                  |                  |    |         |          |            |
| 08-2630LXB                    | Aluminum |                            | 35 $\frac{1}{2}$ | 35 $\frac{1}{2}$ | 28 | 27      | 14.5     | \$ 1144    |
|                               |          | <i>For 30" High Tables</i> |                  |                  |    |         |          |            |
| For 36" Circular Tops         |          |                            | W                | D                | H  | Ship Wt | Cubic Ft | List Price |
| 08-2042SXB                    | Aluminum |                            | 29 $\frac{1}{2}$ | 29 $\frac{1}{2}$ | 40 | 27      | 15.9     | \$ 1158    |
|                               |          | <i>For 42" High Tables</i> |                  |                  |    |         |          |            |
| 08-2036SXB                    | Aluminum |                            | 29 $\frac{1}{2}$ | 29 $\frac{1}{2}$ | 34 | 24      | 13.7     | \$ 1112    |
|                               |          | <i>For 36" High Tables</i> |                  |                  |    |         |          |            |
| 08-2030SXB                    | Aluminum |                            | 29 $\frac{1}{2}$ | 29 $\frac{1}{2}$ | 28 | 21      | 11.6     | \$ 1068    |
|                               |          | <i>For 30" High Tables</i> |                  |                  |    |         |          |            |

#### Description

- Not Available to Be Sold Separately

#### HEIGHT ADJUSTABLE PNEUMATIC X-BASE



| Maximum Round 42", Maximum Square 36" |          |  | W  | D  | H                   | Ship Wt | Cubic Ft | List Price |
|---------------------------------------|----------|--|----|----|---------------------|---------|----------|------------|
| 01-3232HAXBB                          | Black    |  | 32 | 32 | 26-45 $\frac{3}{4}$ | 1       | 0.2      | \$ 1615    |
| 01-3232HAXBA                          | Aluminum |  | 32 | 32 | 26-45 $\frac{3}{4}$ | 1       | 0.2      | \$ 1615    |
| Maximum Round 36", Maximum Square 30" |          |  | W  | D  | H                   | Ship Wt | Cubic Ft | List Price |
| 01-2626HAXBB                          | Black    |  | 22 | 22 | 26-45 $\frac{3}{4}$ | 1       | 0.2      | \$ 1583    |
| 01-2626HAXBA                          | Aluminum |  | 22 | 22 | 26-45 $\frac{3}{4}$ | 1       | 0.2      | \$ 1583    |

#### Description

- Pre-Drilled Boring Pattern May Not Match Underside of Table Top
- Steel Mounting Plate: 8"x 8"x  $\frac{1}{4}$ "
- Eight (8) \*MM Bolts Included for Assembly
- Ships KD

T = TFL P = HPL

[See Canvas Overview For Ordering Options](#)

| Item       | Model No.  |          | W  | D  | H   | Ship Wt | Cubic Ft | List Price |
|------------|------------|----------|----|----|-----|---------|----------|------------|
| METAL BASE | 01-0400MBB | Black    | 32 | 32 | 27¾ | 32      | 3.2      | \$ 936     |
|            | 01-0400MBA | Aluminum | 32 | 32 | 27¾ | 32      | 3.2      | \$ 936     |



Open Market Only

Must Specify (in this order):  
Model # and Quantity

**Description**

- Shipped KD; Some Assembly Required

| Table Widths                    | Circular | 72" | 96" | 120" | 144" | 168" | 192" |
|---------------------------------|----------|-----|-----|------|------|------|------|
| <b>Number of Bases Required</b> | 1        | 2   | 2   | 3    | 3    | 3    | 3    |

|                  |             |                 |    |     |     |    |     |         |
|------------------|-------------|-----------------|----|-----|-----|----|-----|---------|
| STRUT TABLE LEGS | 01-2228STR2 | 1 Pair (2 Legs) | 1½ | 22½ | 28⅞ | 32 | 4.5 | \$ 1199 |
|                  | 01-2228STR4 | 2 Pair (4 Legs) | 1½ | 22½ | 28⅞ | 64 | 9.0 | \$ 2398 |

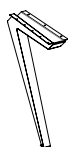

Must Specify (in this order):  
Model # and Quantity  
Color  
Stiffener Bar and Quantity

**Description**

- Available in Aluminum (ALUM) or Black (BLK); Must Specify Color
- Built-In Wire Management Cover on Inside of Legs
- Each Leg has Adjustable Glides
- Legs not Available To Be Sold Separately
- For Use with Indiana Furniture Tops Only; Not For Use with 36" or 42" Circular Tops

**Options: Specify & Add**

|            |               |        |
|------------|---------------|--------|
| 01-00048SB | Stiffener Bar | \$ 234 |
|------------|---------------|--------|

See Individual Tops for Recommended Number of Stiffener Bars

| Table Widths                    | 48" CT | 72" | 96" | 120" | 144" | 168" * | 192" |
|---------------------------------|--------|-----|-----|------|------|--------|------|
| <b>Number of Bases Required</b> | 4      | 4   | 4   | 6    | 6    | 8      | 8    |

\*168" Racetrack Tops Require 6 Bases

|               |                                |  |    |    |     |     |      |          |
|---------------|--------------------------------|--|----|----|-----|-----|------|----------|
| CYLINDER BASE | <b>For Tables 42"D to 48"D</b> |  |    |    |     |     |      |          |
|               | 01-2020CB                      |  | 20 | 20 | 28½ | 136 | 10.9 | W\$ 1456 |
|               | <b>For Tables 36"D</b>         |  |    |    |     |     |      |          |
|               | 01-1616CB                      |  | 16 | 16 | 28½ | 101 | 7.2  | W\$ 1331 |

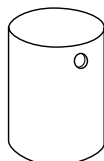

Must Specify (in this order):  
Model # and Quantity  
Finish  
Grommet Options

**Description**

- Veneer Cylinder Base Features Multi-Step, Hand-Finished Catalyzed Finish
- Weighted for Stability
- Two (2) Wire Management Black Grommets Standard at Top Edge; 8" Wire Management Opening Standard at Bottom
- See Number of Bases Required Per Table Width Below

**Additional Grommet Options: Specify & Add**

|       |                                  |        |
|-------|----------------------------------|--------|
| GCBIS | Only One (1) Grommet At Top Edge | \$ N/C |
| NOGC  | No Grommets At Top Edge          | \$ N/C |

| Table Widths                    | Circular | 72" | 96" | 120" | 144" | 168" | 192" |
|---------------------------------|----------|-----|-----|------|------|------|------|
| <b>Number of Bases Required</b> | 1        | 2   | 2   | 3    | 3    | 3    | 3    |

[See Canvas Overview For Ordering Options](#)

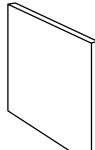
| Item  | Model No.               | W  | D | H   | Ship Wt | Cubic Ft | List Price |
|---|-------------------------|----|---|-----|---------|----------|------------|
| RECTANGULAR PANEL BASE<br> | For Tables 48"D         |    |   |     |         |          |            |
|   | 01-2428RB               | 24 | 2 | 28½ | 34      | 2.7      | P\$ 809    |
|   | For Tables 36"D to 42"D |    |   |     |         |          |            |
|   | 01-2028RB               | 20 | 2 | 28½ | 28      | 2.3      | P\$ 701    |

**Description**

- Stretcher Rails Included; Specify Model (See Below)
- Also available with Arch Stretcher Rails; Sold Separately, See Below
- See Number of Bases Required Per Table Width Below

| Table Widths                      | 72"      | 96"      | 120"      | 144"      | 168"      | 192"      |
|-----------------------------------|----------|----------|-----------|-----------|-----------|-----------|
| <b>Number of Bases Required</b>   | 2        | 2        | 3         | 3         | 3         | 5         |
| <b>Stretcher Rails (Included)</b> | 01-72STR | 01-96STR | 01-120STR | 01-144STR | 01-168STR | 01-192STR |

Must Specify (in this order):

Model # and Quantity  
Color  
Stretcher Rail

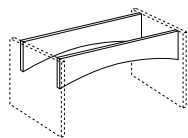
**ARCH STRETCHER RAILS**

|            |     |   |        |    |     |          |
|------------|-----|---|--------|----|-----|----------|
| 01-192ARCH | 192 | ¾ | 8 - 12 | 77 | 4.2 | T\$ 1490 |
| 01-168ARCH | 168 | ¾ | 8 - 12 | 68 | 4.2 | T\$ 901  |
| 01-144ARCH | 144 | ¾ | 8 - 12 | 57 | 4.2 | T\$ 838  |
| 01-120ARCH | 120 | ¾ | 8 - 12 | 46 | 4.2 | T\$ 757  |
| 01-96ARCH  | 96  | ¾ | 8 - 12 | 35 | 4.2 | T\$ 569  |
| 01-72ARCH  | 72  | ¾ | 8 - 12 | 28 | 4.2 | T\$ 517  |

**Description**

- For Use With Rectangular Bases; 01-2428RB or 01-2028RB, See Above
- Must Be Field Installed in Place of the Standard Stretcher Rails Shipped with Rectangular Bases
- Rails for Tables 120" to 168" will Ship as Two (2) Sets of Two (2)
- Rails for Tables 192" will Ship as Four (4) Sets of Two (2)

Must Specify (in this order):

Model # and Quantity  
Color

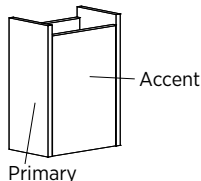
**RECTANGULAR BOX BASE WITH DOOR**

|            |    |    |     |    |     |         |
|------------|----|----|-----|----|-----|---------|
| 01-1220RBD | 20 | 12 | 28½ | 50 | 5.4 | T\$ 617 |
|------------|----|----|-----|----|-----|---------|

**Description**

- Rectangular Base with Lift-Off Removable Panel
- Available in Single or Contrasting Colors; Must Indicate Accent Selection and Primary Selection on Order ([See Color Options](#))
- 2" Wire Management Access Across Both Sides
- Fully Open for Wire Management at the Bottom

| Table Widths                    | 72" | 96" | 120" | 144" | 168" | 192" |
|---------------------------------|-----|-----|------|------|------|------|
| <b>Number of Bases Required</b> | 2   | 2   | 3    | 3    | 3    | 3    |

Must Specify (in this order):

Model # and Quantity  
Primary Color  
Accent Color

| Item       | Model No.                      | W  | D  | H   | Ship Wt | Cubic Ft | List Price |
|------------|--------------------------------|----|----|-----|---------|----------|------------|
| CANOE BASE | 01-1222CS                      | 22 | 12 | 28½ | 27      | 5.8      | W\$ 3340   |
|            | 01-1222CSD<br><i>With Door</i> | 22 | 12 | 28½ | 27      | 5.8      | W\$ 3876   |

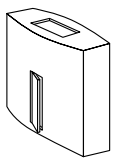

Shown With Door

Must Specify (in this order):

- Model # and Quantity
- Finish
- Grommet Options

**Description**

- Veneer Base Features Multi-Step, Hand-Finished Catalyzed Finish
- Two (2) Wire Management Black Grommets Standard at Top Edge; 6" Wire Management Opening in the Bottom
- Models with Doors Have a 18"H x 6"W Opening (Does Not Feature Soft Close Hinges)
- Adjustable Levelers

**Additional Grommet Options: Specify & Add**

|       |                             |    |     |
|-------|-----------------------------|----|-----|
| GCBIS | One (1) Grommet At Top Edge | \$ | N/C |
| NOGC  | No Grommets At Top Edge     | \$ | N/C |

| Table Widths                    | 72" | 96" | 120" | 144" | 168" | 192" |
|---------------------------------|-----|-----|------|------|------|------|
| <b>Number of Bases Required</b> | 2   | 2   | 3    | 3    | 3    | 3    |

|                     |            |     |   |     |    |     |          |
|---------------------|------------|-----|---|-----|----|-----|----------|
| V-CAPPED PANEL BASE | 01-0430VPB | 30½ | 6 | 27¾ | 28 | 3.5 | P\$ 1956 |
|---------------------|------------|-----|---|-----|----|-----|----------|

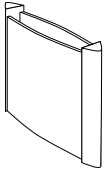

Must Specify (in this order):

- Model # and Quantity
- Color
- Metal Finish

**Description**

- Metal V-Cap Accents Panel Base
- Select From Five (5) Powdercoat Finishes; [See Color Options](#)
- 3" Wire Access Across the Top
- Fully Open for Wire Management at the Bottom
- Adjustable Levelers

| Table Widths                    | 72" | 96" | 120" | 144" | 168" | 192" |
|---------------------------------|-----|-----|------|------|------|------|
| <b>Number of Bases Required</b> | 2   | 2   | 3    | 3    | 3    | 5    |

|                        |            |     |   |     |    |     |          |
|------------------------|------------|-----|---|-----|----|-----|----------|
| FLAT-CAPPED PANEL BASE | 01-0427FPB | 27¾ | 4 | 27¾ | 31 | 3.5 | P\$ 2007 |
|------------------------|------------|-----|---|-----|----|-----|----------|

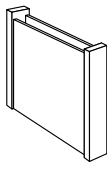

Must Specify (in this order):

- Model # and Quantity
- Color
- Metal Finish

**Description**

- Metal Flat-Cap Accents Panel Base
- Select From Five (5) Powdercoat Finishes; [See Color Options](#)
- 3" Wire Access Across the Top
- Fully Open for Wire Management at the Bottom
- Adjustable Levelers

| Table Widths                    | 72" | 96" | 120" | 144" | 168" | 192" |
|---------------------------------|-----|-----|------|------|------|------|
| <b>Number of Bases Required</b> | 2   | 2   | 3    | 3    | 3    | 5    |

T = TFL P = HPL

[See Canvas Overview For Ordering Options](#)

| Item                               | Model No. | W  | D  | H  | Ship Wt | Cubic Ft | List Price |
|------------------------------------|-----------|----|----|----|---------|----------|------------|
| <b>TWO DOOR BUFFET WITH DRAWER</b> | 94-2436BF | 36 | 24 | 36 | 189     | 21.7     | P\$ 2839   |

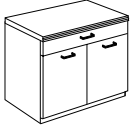

Must Specify (in this order):

Model #  
Top Color  
Edge Profile  
Chassis Color  
Drawer/Door Front Color  
Pull

**Description**

- Standard with: One (1) Drawer, Two (2) Doors with One (1) Adjustable Shelf Behind Doors, Top Profile on Approach Side, and Left to Right Grain Direction on Top Surface
- Available with Contrasting Top and Chassis Colors; Must Specify; [See Color Options](#)
- Drawer/Door Fronts Available in Contrasting Colors; Must Specify; [See Color Options](#)

|  |           |    |    |    |     |      |          |
|--|-----------|----|----|----|-----|------|----------|
| <b>FOUR DOOR BUFFET WITH TWO DRAWERS</b> | 94-2472BF | 72 | 24 | 36 | 342 | 45.6 | P\$ 5526 |
|--|-----------|----|----|----|-----|------|----------|

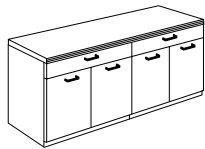

Must Specify (in this order):

Model #  
Top Color  
Edge Profile  
Chassis Color  
Drawer/Door Front Color  
Pull

**Description**

- Standard with: Two (2) Drawers, Four (4) Doors with Two (2) Adjustable Shelves Behind Doors, Top Profile on Approach Side, and Left to Right Grain Direction on Top Surface
- Available with Contrasting Top and Chassis Colors; Must Specify; [See Color Options](#)
- Drawer/Door Fronts Available in Contrasting Colors; Must Specify; [See Color Options](#)

|   |            |    |    |    |     |      |          |
|---|------------|----|----|----|-----|------|----------|
| <b>FOUR DOOR BUFFET WITH TWO DRAWERS AND OPEN STORAGE</b> | 94-2472BFD | 72 | 24 | 36 | 337 | 45.6 | P\$ 6214 |
|---|------------|----|----|----|-----|------|----------|

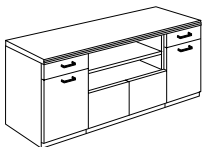

Must Specify (in this order):

Model #  
Top Color  
Edge Profile  
Chassis Color  
Drawer/Door Front Color  
Pull

**Description**

- Standard with: Two (2) Drawers, Left and Right Storage Doors with One (1) Adjustable Shelf Behind Doors, Open Storage with One (1) Adjustable Shelf, Storage Behind Touch Latch Doors in Center, Top Profile on Approach Side, and Left to Right Grain Direction on Top Surface
- Available with Contrasting Top and Chassis Colors; Must Specify; [See Color Options](#)
- Drawer/Door Fronts Available in Contrasting Colors; Must Specify; [See Color Options](#)

T = TFL P = HPL

[See Canvas Overview For Ordering Options](#)

| Item                                | Model No.  | W  | D  | H  | Ship Wt | Cubic Ft | List Price |
|-------------------------------------|------------|----|----|----|---------|----------|------------|
| FOUR DOOR BUFFET WITH THREE DRAWERS | 94-2472SBF | 72 | 24 | 36 | 362     | 45.6     | P\$ 6440   |

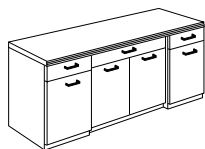

Must Specify (in this order):

Model #  
Top Color  
Edge Profile  
Chassis Color  
Drawer/Door Front Color  
Pull

**Description**

- Standard with: Three (3) Drawers, Left and Right Storage Doors with One (1) Adjustable Shelf Behind Doors, Two (2) Center Doors with One (1) Adjustable Shelf Behind Doors, Stepped Back Center Section, Top Profile on Approach Side, and Left to Right Grain Direction on Top Surface
- Available with Contrasting Top and Chassis Colors; Must Specify; [See Color Options](#)
- Drawer/Door Fronts Available in Contrasting Colors; Must Specify; [See Color Options](#)

|                   |           |    |    |    |     |      |          |
|-------------------|-----------|----|----|----|-----|------|----------|
| TWO DOOR CREDENZA | 94-2436CC | 36 | 24 | 30 | 150 | 17.6 | P\$ 2179 |
|-------------------|-----------|----|----|----|-----|------|----------|

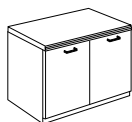

Must Specify (in this order):

Model #  
Top Color  
Edge Profile  
Chassis Color  
Door Front Color  
Pull  
Locking Doors

**Description**

- Standard with: Two (2) Doors with One (1) Adjustable Shelf Behind Doors, Top Profile on Approach Side, and Left to Right Grain Direction on Top Surface
- Available with Contrasting Top and Chassis Colors; Must Specify; [See Color Options](#)
- Door Fronts Available in Contrasting Colors; Must Specify; [See Color Options](#)
- Optional Locking Doors Available, [See Locking Options](#)

|                    |           |    |    |    |     |      |          |
|--------------------|-----------|----|----|----|-----|------|----------|
| FOUR DOOR CREDENZA | 94-2472CC | 72 | 24 | 30 | 290 | 34.2 | P\$ 4321 |
|--------------------|-----------|----|----|----|-----|------|----------|

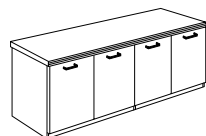

Must Specify (in this order):

Model #  
Top Color  
Edge Profile  
Chassis Color  
Door Front Color  
Pull  
Locking Doors

**Description**

- Standard with: Four (4) Doors with Two (2) Adjustable Shelf Behind Doors, Top Profile on Approach Side, and Left to Right Grain Direction on Top Surface
- Available with Contrasting Top and Chassis Colors; Must Specify; [See Color Options](#)
- Door Fronts Available in Contrasting Colors; Must Specify; [See Color Options](#)
- Optional Locking Doors Available, [See Locking Options](#)

T = TFL P = HPL

[See Canvas Overview For Ordering Options](#)

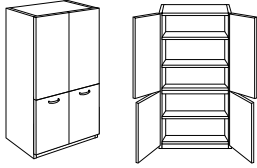

| Item                        | Model No.  | W  | D  | H                               | Ship Wt | Cubic Ft | List Price |
|-----------------------------|------------|----|----|---------------------------------|---------|----------|------------|
| DOUBLE DOOR STORAGE CABINET | 94-3672SUD | 36 | 24 | 70 <sup>3</sup> / <sub>16</sub> | 285     | 42.0     | T\$ 4297   |

**Description**

- Top Section has Two (2) Adjustable Shelves; Bottom Section has One (1) Adjustable Shelf
- Pull Installed Vertically on Lower Doors; Capsule Pull will be Substituted for Elite, Buckle, and Flair Pulls; [See Pull Options](#)
- Touch Latch Doors on Top Section

Must Specify (in this order):

Model #  
Color  
Pull

| WARDROBE/STORAGE CABINET | HINGED LEFT | HINGED RIGHT |    |    |                                 |     |      |          |
|--------------------------|-------------|--------------|----|----|---------------------------------|-----|------|----------|
|                          | 94-1872WL   | 94-1872WR    | 18 | 24 | 70 <sup>3</sup> / <sub>16</sub> | 155 | 22.0 | T\$ 2419 |

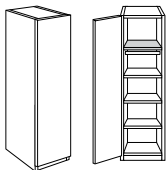

Shown as Left

**Description**

- Fixed Top Shelf; Coat Rod Under Fixed Shelf
- Three (3) Adjustable Shelves Behind Door
- Adjustable Shelves can be Removed for Wardrobe Application
- Touch Latch Door

Must Specify (in this order):

Model #  
Color

|            |           |    |    |                                |     |     |          |
|------------|-----------|----|----|--------------------------------|-----|-----|----------|
| VISOR RAIL | 94-2472VR | 72 | 24 | 5 <sup>5</sup> / <sub>16</sub> | 100 | 8.9 | T\$ 1155 |
|------------|-----------|----|----|--------------------------------|-----|-----|----------|

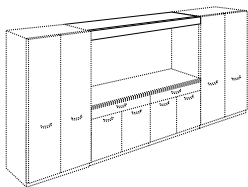
**Description**

- Overhead Rail Creates Wall Unit
- For Use with 72" High Cabinets and Credenzas/Buffets (Ordered Separately)

**Options: Specify & Add**Must Specify (in this order):

Model #  
Color  
Projection Screen  
Task Light

|         |   |        |
|---------|---|--------|
| 1-PS    | Projection Screen (Requires Field Installation) | \$ 996 |
| TL-0848 | Task Light (Requires Field Installation)        | \$ 417 |

T = TFL P = HPL

[See Canvas Overview For Ordering Options](#)

| Item                | Model No. | W  | D  | H  | Ship Wt | Cubic Ft | List Price |
|---------------------|-----------|----|----|----|---------|----------|------------|
| MOBILE SERVING CART | 94-2436SV | 36 | 24 | 36 | 149     | 24.0     | P\$ 3425   |



**Description**

- Top Edge Profiled on Approach Side Only; Must Specify Edge Selection; [See Edge Profile Options](#)
- Two (2) Box Drawers with Storage Behind Two (2) Doors
- Open Storage
- Locking Casters

Must Specify (in this order):

- Model #
- Color
- Edge Profile
- Pull
- Grommet Option

**Grommet Option: Specify & Add**

|        |   |       |
|--------|---|-------|
| 1-GRMT | Grommet in Back Panel; Must Specify Black or Silver | \$ 72 |
|--------|---|-------|

|               |           |    |    |    |     |      |          |
|---------------|-----------|----|----|----|-----|------|----------|
| LECTERN STAND | 94-2650LS | 26 | 24 | 50 | 130 | 21.9 | P\$ 2487 |
|---------------|-----------|----|----|----|-----|------|----------|



**Description**

- Top Edge Profiled on Approach Side Only; Must Specify Edge Selection; [See Edge Profile Options](#)
- Fixed Reading Shelf
- Pullout Shelf
- Two (2) Adjustable Storage Shelves in Lower Compartment
- Two (2) Locking and Two (2) Non-Locking Casters
- Wire Management Grommet in Bottom Shelf

Must Specify (in this order):

- Model #
- Color
- Edge Profile

|              |           |    |   |    |     |      |          |
|--------------|-----------|----|---|----|-----|------|----------|
| VISUAL BOARD | 94-4848VB | 48 | 5 | 48 | 150 | 11.0 | T\$ 2773 |
|--------------|-----------|----|---|----|-----|------|----------|

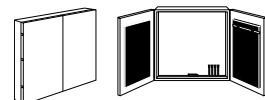

**Description**

- Tackboard on Each Door Standard in Black Fabric Unless Specified; Price Valid for Grades 1, 2, & 3 (See Other Pricing Below)
- Display Rail with Adjustable Hooks for Flipchart
- Magnetic Porcelain Non-Glare Writing Surface
- Includes Flipchart, Set of Four (4) Dry Erase Markers and Eraser, Mounting Hardware
- Does Not Feature Soft Close Hinges

Must Specify (in this order):

- Model #
- Color
- Projection Screen
- Tackboard Fabric

**Options: Specify & Add**

|  | Grade 4 | Grade 5 | Grade 6 | Grade 7 | Grade 8 | Grade 9 | Grade 10 |
|--|---------|---------|---------|---------|---------|---------|----------|
| Tackboard Fabric Change                              | \$ 260  | 382     | 506     | 684     | 866     | 1082    | 1328     |
| 1-PS Projection Screen (Requires Field Installation) |         |         |         |         |         |         | \$ 996   |

|                          |              |                 |                  |                  |    |     |         |
|--------------------------|--------------|-----------------|------------------|------------------|----|-----|---------|
| TABLE POWER & DATA VAULT | 01-CVAULTG2A | 4 $\frac{1}{8}$ | 15 $\frac{1}{8}$ | 4 $\frac{1}{16}$ | 10 | 0.4 | \$ 1823 |
|--------------------------|--------------|-----------------|------------------|------------------|----|-----|---------|



Open Market Only

**Description**

- Electric Drive Motor Rotates the Surface Technology 180° to the Proper Position
- Photo-Electronic Eye Prevents Rotation When Obstructed
- Two (2) Data Ports, Three (3) Power Outlets, One (1) HDMI and Two (2) 5V USB
- 6' Power Cord
- UL and CSA Recognized

T = TFL P = HPL

[See Canvas Overview For Ordering Options](#)

| Item                     | Model No.   |          | W   | D  | H  | Ship Wt | Cubic Ft | List Price |
|--------------------------|-------------|----------|-----|----|----|---------|----------|------------|
| WORKSURFACE POWER CENTER | 01-INTRFC1A | Aluminum | 14¼ | 6¾ | 2⅞ | 11      | 0.3      | \$ 1936    |
|                          | 01-INTRFC1B | Black    |     |    |    |         |          |            |



### Description

- For Use with Conference Tables
- Four (4) Power Outlets, Three (3) Telecom Plate Openings
- Two (2) Telecom Plates Included with the Unit: One (1) 01-ABLAB Plate (Consists of One (1) RJ45 Cat 6, One (1) RJ11 Cat 3 Phone Jack); One (1) 01-ABLBB Plate (Consists of Two (2) RJ45 Cat 6)
- 6' Power Cord
- Convenience Plug on Bottom
- UL Listed/CSA Certified
- Additional Telecom Plates, [See ECA Telecom Plate Options](#)

|                         |            |          |     |    |    |    |     |         |
|-------------------------|------------|----------|-----|----|----|----|-----|---------|
| OASIS MINI POWER & DATA | 01-OASISMA | Aluminum | 14¼ | 6¾ | 2⅞ | 11 | 0.3 | \$ 2993 |
|                         | 01-OASISMB | Black    |     |    |    |    |     |         |



### Description

- For Use with Conference Tables
- Soft Touch Hinged Lid
- Four (4) Power Outlets, Three (3) Telecom Plate Openings
- Two (2) Telecom Plates Included with the Unit: One (1) 01-ABLAB Plate (Consists of One (1) RJ45 Cat 6, One (1) RJ11 Cat 3 Phone Jack); One (1) 01-ABLBB Plate (Consists of One (1) RJ45 Cat 6)
- 9' Power Cord
- UL Listed
- Additional Telecom Plates, [See ECA Telecom Plate Options](#)

|                       |                |          |   |    |    |   |     |        |
|-----------------------|----------------|----------|---|----|----|---|-----|--------|
| INTERACT POWER & DATA | 01-INTERACTG2A | Aluminum | 9 | 5⅝ | 2¾ | 5 | 0.2 | \$ 836 |
|                       | 01-INTERACTG2B | Black    |   |    |    |   |     |        |



### Description

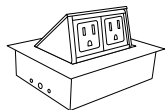

- Includes: Two (2) Power Outlets, Two (2) USB-A Charging Ports, One (1) Telecom Plate Opening; Two (2) Keystone Openings for Voice/Data Jacks
- One (1) Telecom Plates Included with the Unit: One (1) 01-ABLAB Plate (Consists of One (1) RJ45 Cat 6, One (1) RJ11 Cat 3 Phone Jack)
- Convenience Plug on Bottom
- 6' Power Cord
- UL and CSA Recognized
- Additional Telecom Plates, [See ECA Telecom Plate Options](#)

|           |             |          |    |    |   |   |     |        |
|-----------|-------------|----------|----|----|---|---|-----|--------|
| POWER 440 | 01-DATA440A | Aluminum | 5⅝ | 4⅜ | - | 5 | 0.2 | \$ 904 |
|           | 01-DATA440B | Black    |    |    |   |   |     | \$ 904 |

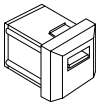
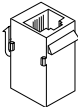

### Description

- Two (2) Power Outlets
- Soft Touch Hinged Lid
- 6' Power Cord
- UL and CSA Recognized

| Item  | Model No.  |   | W                 | D                 | H | Ship Wt | Cubic Ft | List Price |
|---|------------|---|-------------------|-------------------|---|---------|----------|------------|
| POWER DATA PORT   | 01-DPORT4A | Aluminum  | 8                 | 4                 | - | 7       | 0.2      | \$ 1025    |
|   | 01-DPORT4B | Black   |                   |                   |   |         |          | \$ 1025    |
|    |            | <b>Description</b> <ul style="list-style-type: none"> <li>Retracts into Work Surface to Regain Productive Space; One-Touch Access to Power and Data</li> <li>Two (2) Power Outlets and Two (2) Open Ports for Data</li> <li>Optional Telecom Port Components, See Below</li> <li>Water-Proof Simplex (Outlets)</li> <li>Includes a Voice/Data Adapter Kit to Accept Couplers and Jacks When Required</li> <li>6' Power Cord</li> <li>UL and CSA Recognized</li> </ul> |                   |                   |   |         |          |            |
| USB PORT  | 01-USBPORT |   | -                 | -                 | - | -       | -        | \$ 151     |
|    |            | <b>Description</b> <ul style="list-style-type: none"> <li>Increases Transfer Speed Up to 5 gbs/sec</li> <li>Simultaneous Read/Write Capability; Idle Device Power Saving State</li> <li>6' Cord</li> <li>Compatible with 01-DPORT4A and 01-DPORT4B</li> </ul>   |                   |                   |   |         |          |            |
| VOICE COUPLER   | 01-VOICE1  |   | -                 | -                 | - | -       | -        | \$ 69      |
|  |            | <b>Description</b> <ul style="list-style-type: none"> <li>6-Pin Modular Plug</li> <li>Molded Black; Cord Not included</li> <li>Compatible with 01-DPORT4A and 01-DPORT4B</li> </ul>   |                   |                   |   |         |          |            |
| DATA PORT   | 01-RJ4DATA |   | -                 | -                 | - | -       | -        | \$ 156     |
|  |            | <b>Description</b> <ul style="list-style-type: none"> <li>8-Pin Modular Plug; Cat 5 Ethernet Cable; Pre-terminated Cable</li> <li>9' Cord</li> <li>Compatible with 01-DPORT4A and 01-DPORT4B</li> </ul>   |                   |                   |   |         |          |            |
| ROUND GROMMET COVER   | 01-GRMTB   | Black   | 2 $\frac{3}{8}$ " | 2 $\frac{3}{8}$ " | - | 1       | 0.1      | \$ 33      |
|   | 01-GRMTSL  | Silver  |                   |                   |   |         |          | \$ 33      |
|  |            | <b>Description</b> <ul style="list-style-type: none"> <li>2<math>\frac{3}{8}</math>" (60mm) Round Grommet Cover</li> <li>Field Installed</li> </ul>   |                   |                   |   |         |          |            |
| Open Market Only  |            | <i>Open Market Only</i>   |                   |                   |   |         |          |            |

[See Canvas Overview For Ordering Options](#)

| Item                     | Model No.   |        | W | D | H | Ship Wt | Cubic Ft | List Price |
|--------------------------|-------------|--------|---|---|---|---------|----------|------------|
| SINGLE POWER SAND DOLLAR | 01-SAND60PS | Silver | 3 | 3 | 4 | 1       | 0.2      | \$ 92      |
|                          | 01-SAND60PW | White  |   |   |   |         |          | \$ 92      |
|                          | 01-SAND60PB | Black  |   |   |   |         | \$ 92    |            |

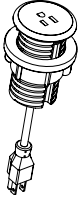
**Description**

- Mounts in 2 $\frac{3}{8}$ " (60mm) Round Grommet
- Single Power Outlet with 6' Cord

|                        |             |        |   |   |   |   |        |        |
|------------------------|-------------|--------|---|---|---|---|--------|--------|
| DOUBLE USB SAND DOLLAR | 01-SAND60US | Silver | 3 | 3 | 4 | 1 | 0.2    | \$ 260 |
|                        | 01-SAND60UW | White  |   |   |   |   |        | \$ 260 |
|                        | 01-SAND60UB | Black  |   |   |   |   | \$ 260 |        |

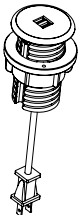
**Description**

- Mounts in 2 $\frac{3}{8}$ " (60mm) Round Grommet
- Dual USB Outlets with 6' Cord

|                     |              |        |                 |   |   |   |        |        |
|---------------------|--------------|--------|-----------------|---|---|---|--------|--------|
| DUO CLAMP NEMA PLUG | 01-DUOCLAMPS | Silver | 5 $\frac{1}{2}$ | 3 | 7 | 1 | 0.2    | \$ 537 |
|                     | 01-DUOCLAMPW | White  |                 |   |   |   |        | \$ 537 |
|                     | 01-DUOCLAMPB | Black  |                 |   |   |   | \$ 537 |        |

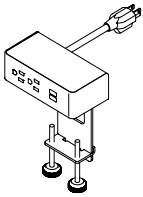

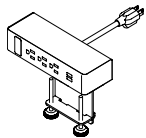

**Description**

- Standard with: Two (2) Power Outlet, Two (2) USB Ports, 10' Cord
- Clamps to Top and Features Silver Metal Trim
- Independent USB Circuit Controllers Deliver up to 2.1 Amps to Each Post
- All Mounting Hardware Included
- FCC Part 15A and UL Approved for Horizontal and Vertical Applications

|                      |               |        |   |   |   |   |        |        |
|----------------------|---------------|--------|---|---|---|---|--------|--------|
| TRIO CLAMP NEMA PLUG | 01-TRIOCLAMPS | Silver | 8 | 3 | 7 | 1 | 0.2    | \$ 629 |
|                      | 01-TRIOCLAMPW | White  |   |   |   |   |        | \$ 629 |
|                      | 01-TRIOCLAMPS | Black  |   |   |   |   | \$ 629 |        |

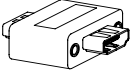
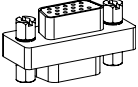
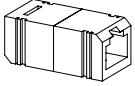
**Description**

- Standard with: Three (3) Power Outlets, Two (2) USB Ports, One (1) Open Data, 10' Cord
- Clamps to Top and Features Silver Metal Trim
- Independent USB Circuit Controllers Deliver up to 2.1 Amps to Each Post
- HDMI, VGA, or RJ45 Accessories Sold Separately, [See Port Accessories](#)
- All Mounting Hardware Included
- FCC Part 15A and UL Approved for Horizontal and Vertical Applications

| Item  | Model No.   |       | W                  | D                  | H               | Ship Wt | Cubic Ft | List Price |
|---|---|-------|--------------------|--------------------|-----------------|---------|----------|------------|
| HDMI DATA PORT ACCESSORY FOR TRIO UNITS   | 01-LCOMHDMI   |       | -                  | -                  | -               | 1       | 0.2      | \$ 155     |
|    | <b>Description</b>  |       |                    |                    |                 |         |          |            |
| Open Market   | • HDMI Port for Trio Units  |       |                    |                    |                 |         |          |            |
| VGA DATA PORT ACCESSORY FOR TRIO UNITS  | 01-LCOMVGA  |       | -                  | -                  | -               | 1       | 0.2      | \$ 114     |
|    | <b>Description</b>  |       |                    |                    |                 |         |          |            |
|   | • VGA Port for Trio Units   |       |                    |                    |                 |         |          |            |
| RJ45 DATA PORT ACCESSORY FOR TRIO UNITS   | 01-LCOMRJ45   |       | -                  | -                  | -               | 1       | 0.2      | \$ 74      |
|    | <b>Description</b>  |       |                    |                    |                 |         |          |            |
|   | • RJ45 Port for Trio Units  |       |                    |                    |                 |         |          |            |
| DOCK 950 WIRELESS CHARGER   | 01-DOCK950W   | White | 3 $\frac{3}{16}$ " | 3 $\frac{3}{16}$ " | -               | 1       | 0.2      | \$ 249     |
|  | 01-DOCK950B   | Black |                    |                    |                 |         |          | \$ 249     |
| Open Market Only  | <b>Description</b>  |       |                    |                    |                 |         |          |            |
|   | • For Use with Wireless Charging Enabled Devices  |       |                    |                    |                 |         |          |            |
|   | • 5 Watts Maximum Output with a Direct Current of 5V 2A and 10 Watts Maximum with Quick Charge 2.0  |       |                    |                    |                 |         |          |            |
|   | • LED will Confirm Pairing with Device and Begin Wireless Charging  |       |                    |                    |                 |         |          |            |
| WIRELESS AND USB CHARGER  | 01-DOCK150W   | White | 3                  | 3                  | $\frac{3}{4}$ " | 1       | 0.2      | \$ 380     |
|  | 01-DOCK150B   | Black |                    |                    |                 |         |          | \$ 380     |
| Open Market Only  | <b>Description</b>  |       |                    |                    |                 |         |          |            |
|   | • For Use with Wireless Charging Enabled Devices and USB Charging Devices   |       |                    |                    |                 |         |          |            |
|   | • 5 Watt Maximum Output with a Direct Current Input of 5V 6A (Wireless Fast Charge)   |       |                    |                    |                 |         |          |            |
|   | • Pop-Up is $\frac{3}{4}$ "H and Includes Three (3) USB Ports; One (1) 12 Watt Maximum with 2.4A (USB Fast Charge) and Two (2) 5 Watt with 1A (USB Standard Charge) |       |                    |                    |                 |         |          |            |
|   | • LED Light will Confirm Pairing with Device and Begin Wireless Charging  |       |                    |                    |                 |         |          |            |
|   | • UL and cUL Certified  |       |                    |                    |                 |         |          |            |

[See Canvas Overview For Ordering Options](#)

| Item               | Model No. | W                | D  | H                | Ship Wt | Cubic Ft | List Price |
|--------------------|-----------|------------------|----|------------------|---------|----------|------------|
| VESTA POWER CENTER | 01-PDCTR  | 10 $\frac{3}{4}$ | 12 | 28 $\frac{1}{4}$ | 14      | 2.5      | \$ 1666    |

**Description**

- Top Includes One (1) Power Outlet, Two (2) USB Ports and One (1) USBC Port; Base Includes Three (3) Outlets
- Available in White
- 120" Power Cord
- Built with Weight Distribution for Optimal Stability
- Base is 5" Tall

|             |         |   |   |   |   |   |        |
|-------------|---------|---|---|---|---|---|--------|
| POWER STRIP | 01-PRSP | 9 | 2 | 2 | 1 | - | \$ 192 |
|-------------|---------|---|---|---|---|---|--------|

**Description**

- Includes Four (4) Outlets and Two (2) Phone Jacks
- Black Plastic with Rocker On/Off Switch
- 13 Amp Circuit Breaker
- 10' Power Cord and Two (2) 14' Phone Hook Up Cords
- UL Listed and CSA Certified
- Suitable for Surface or Recessed Mounting
- Ships via UPS Only

|                         |          |    |                 |               |   |   |        |
|-------------------------|----------|----|-----------------|---------------|---|---|--------|
| WIRE MANAGEMENT CHANNEL | 01-WMGR4 | 16 | 1 $\frac{1}{2}$ | $\frac{3}{4}$ | 1 | - | \$ 109 |
|-------------------------|----------|----|-----------------|---------------|---|---|--------|

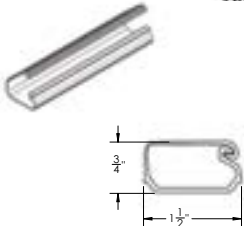
**Description**

- Set of Four (4) Black Plastic Wire Management Channels
- Snap Lock Channel
- Attaches with Adhesive Strips
- Ships via UPS Only

|            |           |                 |                 |   |   |   |       |
|------------|-----------|-----------------|-----------------|---|---|---|-------|
| CABLE GRIP | 01-WMGRCB | 5 $\frac{3}{8}$ | 2 $\frac{5}{8}$ | - | - | - | \$ 16 |
|------------|-----------|-----------------|-----------------|---|---|---|-------|

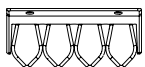
**Description**

- Under Surface Wire Management
- Black

| Item               | Model No.   | Description                          | List Price   |        |
|--------------------|---|--------------------------------------|--|--------|
| ECA TELECOM PLATES | 01-ABL  | Telecom Plate, Blank Plate           | \$ 39  |        |
|                    | 01-ABL737373  | Telecom Plate, Three (3) RJ45 Cat 5e | \$ 345   |        |
|                    | Compatible with:  |                                      |  |        |
|                    |  | 01-ABLAB                             | Telecom Plate, One (1) RJ45 Cat 6, One (1) RJ11 Cat 3 Phone  | \$ 193 |
|                    |  | 01-ABLAB102                          | Telecom Plate, One (1) RJ45 Cat 6, One (1) RJ11 Cat 3, One (1) USB W/72" Patch Cord                              | \$ 300 |
|                    | Oasis Mini Power & Data<br>01-OASISMA, 01-OASISMB                                 | 01-ABLABB                            | Telecom Plate, Two (2) RJ45 Cat 6, One (1) RJ11 Cat 3 Phone  | \$ 300 |
|                    |  | 01-ABLB                              | Telecom Plate, One (1) RJ45 Cat 6  | \$ 140 |
|                    | Interact Power & Data<br>01-INTERACTG2A, 01-INTERACTG2B                           | 01-ABLB                              | Telecom Plate, Two (2) RJ45 Cat 6  | \$ 244 |
|                    |  | 01-ABLB                              | Telecom Plate, Three (3) RJ45 Cat 6  | \$ 345 |
|                    | Power Center<br>01-INTRFCIA, 01-INTRFCIB  | 01-ABLB                              | Telecom Plate, Four (4) RJ45 Cat 6   | \$ 447 |
|                    |   | 01-ABLBBB                            | Telecom Plate, Two (2) RJ45 Cat 6, One (1) 15 Pin HD VGA w/72" Patch Cord  | \$ 418 |
|                    |   | 01-ABLBBB                            | Telecom Plate, One (1) RJ45 Cat 6, One (1) Mini Stereo Inline, One (1) 15 Pin HD VGA w/72" Patch Cord            | \$ 384 |
|                    |   | 01-ABLBBB                            | Telecom Plate, One (1) RJ45 Cat 6 Data Inline, One (1) RJ11 Cat 3 Phone Inline                                   | \$ 184 |
|                    |   | 01-ABLBBB                            | Telecom Plate, One (1) HDMI w/36" Patch Cord   | \$ 277 |
|                    |   | 01-ABLBBB                            | Telecom Plate, One (1) Mini Stereo Inline, One (1) HDMI w/36" Patch Cord, One (1) 15 Pin HD VGA w/72" Patch Cord | \$ 523 |
|                    |   | 01-ABLBBB                            | Telecom Plate, One (1) 15 Pin HD VGA & One (1) Mini Stereo Inline Jack   | \$ 280 |
|                    |   | 01-ABLBBB                            | Telecom Plate, Three (3) Cord Bushings   | \$ 90  |

[See Canvas Overview For Ordering Options](#)



Featuring wood or high pressure laminate tops, Gesso tables complement Gesso Casegoods and other contemporary offerings to create a seamless look across working environments. Select from the full line of storage and table top power centers, as well as base styles that accommodate technology access doors.

### CONSTRUCTION

*Gesso Tables and Components feature either a Veneer or HPL top and Veneer chassis (where applicable), unless otherwise noted.*

### VENEERS

- Exposed surfaces on Gesso models feature Cherry, Maple, or American Black Walnut veneers, carefully selected and matched to assure proper balance and consistency

### LAMINATES

- Exposed surfaces are produced from wood grained laminates fused to a particle-board core
- Each laminate offers lasting beauty, superior resistance to normal wear, and easy maintenance

### TOPS

- Wood Veneer and High Pressure Laminate (HPL) tops are 3-ply balanced construction, 1 $\frac{1}{16}$ " thick
- 3mm wood edge-banded rims contoured to the selected profile
- Tops are shaped on all four sides
- Grain direction runs left to right, unless otherwise noted

### CHASSIS

- Tops and end panels are securely fastened using high quality European fastening systems to assure maximum strength
- All units are equipped with heavy-duty, adjustable glides to ensure proper leveling and compensation for uneven floors

### DRAWERS

- All drawer fronts are standard with elegant vertically matched veneer faces
- Drawers feature 5-sided construction with  $\frac{3}{4}$ " 3-ply fronts,  $\frac{7}{16}$ " thick hardwood sides and  $\frac{5}{32}$ " hardboard bottoms
- Units with 36" wide file drawers feature  $\frac{1}{4}$ " thick drawer bottoms for maximum storage strength
- Drawer interiors are sanded, sealed, and finished to provide for a smooth, quality feel and appearance
- All drawers feature full extension, progressive action slides with precision steel ball bearings
- Box and file drawers are tested for 100lb capacity
- Lateral files are tested for 200lb capacity
- All suspensions have a limited lifetime warranty

### STORAGE

- All hinged doors include soft close hinges, unless otherwise noted
- One piece hinge and base plate combination
- Soft close hinges reduce stress placed on the cabinet when the door is closed and offers a quiet closure

### LOCKING

- All units with file drawers feature locking
- Removable lock cylinders allow for units to be re-keyed at a later date if required
- Units are shipped randomly keyed as standard. Keyed alike units available upon request at no additional charge.
- Keyed alike units available upon request at no additional charge
- Lock cores match pull color

### INTERIOR DRAWER DIMENSIONS

#### Models

97-2472BFD      97-2436SV

#### Drawers

Box      **W**      **L**      **D**  
 14 $\frac{17}{32}$ "      19 $\frac{1}{4}$ "      3 $\frac{21}{32}$ "

#### Models

97-2436BF      97-2472BF

#### Drawers

Box      **W**      **L**      **D**  
 32 $\frac{9}{16}$ "      19 $\frac{1}{4}$ "      3 $\frac{21}{32}$ "

#### Models

97-2472SBF

#### Drawers

Box      **W**      **L**      **D**  
 14 $\frac{17}{32}$ "      19 $\frac{1}{4}$ "      3 $\frac{21}{32}$ "

Box      32 $\frac{9}{16}$ "      19 $\frac{1}{4}$ "      3 $\frac{21}{32}$ "

### HOW TO ORDER EXAMPLES

|                      | QTY | MODEL NO.         | DESCRIPTION                 | EXAMPLE                |
|----------------------|-----|-------------------|-----------------------------|------------------------|
| <b>TOP</b>           | 1   | 97-48120RT        | Top Material                | P                      |
|                      |     |                   | Finish/Color                | HVM                    |
|                      |     |                   | Edge Profile                | G                      |
|                      |     |                   | Grommet/Power/Data Location | OC                     |
| <b>BASES</b>         | 2   | 01-2020CB         | Finish                      | HVM                    |
|                      |     |                   | Grommet                     | GCBIS                  |
| <b>PORTS</b>         | 1   | 01-INTERACTG2B    |                             |                        |
| <b>TELECOM PLATE</b> | 1   | 01-ABLABB         |                             |                        |
| <b>VISUAL BOARD</b>  | 1   | 97-4848VB         | Finish                      | HVM                    |
|                      |     |                   | Pull/Color                  | AEL                    |
|                      |     |                   | Upholstery                  | Momentum<br>Jot Fossil |
|                      |     | Projection Screen | PS                          |                        |

### VENEER (W) OPTIONS

Veneer features UVAdvantage, an ultra-violet finish, on all exposed surfaces by utilizing roll-coat UV technology

|     |                    |     |                     |
|-----|--------------------|-----|---------------------|
| AW  | Artisan Walnut     | MW  | Mahogany Walnut     |
| AS  | Asian Night        | MO  | Medium Oak*         |
| CO  | Columbian Walnut   | ORW | Oak Riftwood*       |
| DC  | Dark Cherry        | SCH | Select Cherry       |
| DFW | Dark Forest Walnut | SKC | Shaker Cherry       |
| EW  | Espresso           | SBP | Smoky Brown Pear    |
| FO  | Fawn Oak*          | SM  | Sugar Maple         |
| GC  | Golden Cherry      | SW  | Sunglow Walnut      |
| HVM | Harvest Maple      | WTA | Weathered Ash*      |
| HW  | Harvest Walnut     | WC  | Williamsburg Cherry |
| LW  | Legacy Walnut      |     |                     |

\*Finish is Low Sheen

### EDGE PROFILES

|   |             |   |        |
|---|-------------|---|--------|
| F | Double Kerf | X | Flute  |
| G | Duo         | Y | Square |



### METAL FINISH OPTIONS

|      |          |      |              |
|------|----------|------|--------------|
| ALUM | Aluminum | OYST | Oyster White |
| MIST | Mist     | SUGC | Sugar Cookie |
| NOIR | Noir     |      |              |

### GROMMET/POWER/DATA OPTIONS & LOCATIONS

[See Multiple Top Shapes and Sizes](#) and [See Locations for Power/Data Options](#)

Work Table Grommet and Power Options and Locations below:

|            |            |            |
|------------|------------|------------|
| 65-4896WT  | 65-4860CWT | 65-4260TWT |
| 65-4896TWT | 65-4296WT  | 65-4260CWT |
| 65-4896CWT | 65-4296TWT | 65-3696TWT |
| 65-4884WT  | 65-4296CWT | 65-3696CWT |
| 65-4884TWT | 65-4284WT  | 65-3684TWT |
| 65-4884CWT | 65-4284TWT | 65-3684CWT |
| 65-4872WT  | 65-4284CWT | 65-3672TWT |
| 65-4872TWT | 65-4272WT  | 65-3672CWT |
| 65-4872CWT | 65-4272TWT | 65-3660TWT |
| 65-4860WT  | 65-4272CWT | 65-3660CWT |
| 65-4860TWT | 65-4260WT  |            |

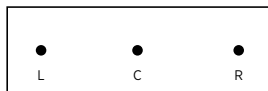

**48" Work Tables**  
 GL/GR/PDC-L/PDC-R/DOCK950-L/  
 DOCK950-R/DOCK150-L/  
 DOCK150-R: Located 6" from ends  
 and 24" from user  
 GC/PDC-C/DOCK950-C/  
 DOCK150-C: Located 24" from user

**42" Work Tables**  
 GL/GR/PDC-L/PDC-R/DOCK950-L/  
 DOCK950-R/DOCK150-L/DOCK150-R:  
 Located 6" from ends and 21" from user  
 GC/PDC-C/DOCK950-C/DOCK150-C:  
 Located 21" from user

**36" Work Tables**  
 GL/GR/PDC-L/PDC-R/DOCK950-L/  
 DOCK950-R/DOCK150-L/DOCK150-R:  
 Located 6" from ends and 18" from user  
 GC/PDC-C/DOCK950-C/DOCK150-C:  
 Located 18" from user

### PULL OPTIONS

Note: Lock Core will match Pull Color

|     |                   |     |                  |
|-----|-------------------|-----|------------------|
| AAV | Alcove, Aluminum  | BEL | Elite, Black     |
| CAV | Alcove, Chrome    | AFL | Flair, Aluminum  |
| AAC | Arc, Aluminum     | CFL | Flair, Chrome    |
| BAC | Arc, Black        | AFC | Focus, Aluminum  |
| ABM | Beam, Aluminum    | BFC | Focus, Black     |
| BBM | Beam, Black       | AQD | Quadra, Aluminum |
| ABT | Bow Tie, Aluminum | BQD | Quadra, Black    |
| NBT | Bow Tie, Nickel   | AST | Studio, Aluminum |
| ABU | Buckle, Aluminum  | BST | Studio, Black    |
| BBU | Buckle, Black     | CST | Studio, Chrome   |
| AEL | Elite, Aluminum   |     |                  |



### DRAWER OPTIONS

Units with drawers come standard with woodgrain vinyl-wrapped drawers. Optional wood dove tail construction for all box, file, and lateral file drawers is available. Soft close is also available for all box drawers. Must specify when ordering.

Pricing is per Drawer, not per Model/Unit.

|       |   |    |    |
|-------|---|----|----|
| DOVE  | Wood Dove Tail Construction                       | \$ | 42 |
| SFTCL | Soft Close Drawer Track (Box & File Drawers Only) | \$ | 32 |

### LOCKING DOORS

Locking doors are available on specific units, where noted. You must specify WITH LOCKING when ordering and add upcharge.

|        |                    |    |     |
|--------|--------------------|----|-----|
| LKT_HU | 72"W to 48"W Units | \$ | 108 |
| LKT_HU | 42"W to 30"W Units | \$ | 85  |
| LKT_HU | 18"W Units         | \$ | 65  |

### CERTIFICATIONS & COMPLIANCE

- Intertek Sustainability Certified
- BIFMA level® Certified
- BIFMA Compliant® Certified
- TSCA Title VI (formerly CARB) Compliance
- US Green Building's LEED® Contribution

**Work Tables**

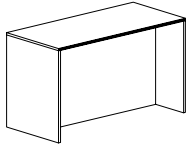

Standing Height [\(See Details\)](#)

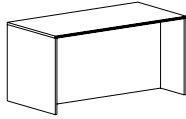

Counter Height [\(See Details\)](#)

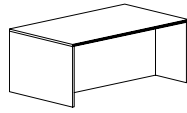

Seated Height [\(See Details\)](#)

**Tops/Shapes**

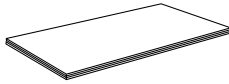

Rectangular [\(See Details\)](#)



Arc Rectangular [\(See Details\)](#)

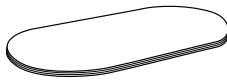

Racetrack [\(See Details\)](#)

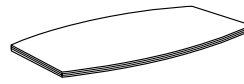

Boat-Shaped [\(See Details\)](#)



Circular [\(See Details\)](#)

**Bases**

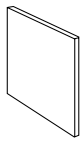

Rectangular Panel [\(See Details\)](#)

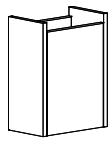

Rectangular with Door [\(See Details\)](#)

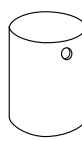

Cylinder [\(See Details\)](#)

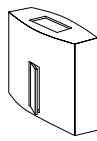

Canoe [\(See Details\)](#)

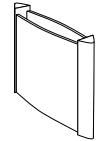

V-Capped Panel [\(See Details\)](#)

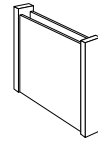

Flat-Capped Panel [\(See Details\)](#)



Metal [\(See Details\)](#)



Strut [\(See Details\)](#)



Disc Base [\(See Details\)](#)



Height Adjustable Base [\(See Details\)](#)

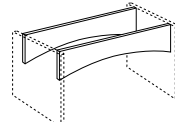

Arch Stretcher Rails [\(See Details\)](#)

**Storage Components**

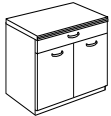

Two Door Buffet w/Drawer [\(See Details\)](#)

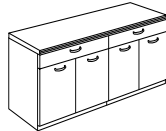

Four Door Buffet w/2 Drawers [\(See Details\)](#)

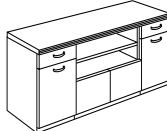

Four Door Buffet w/2 Drawers & Open Storage [\(See Details\)](#)

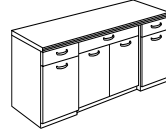

Four Door Buffet w/3 Drawers [\(See Details\)](#)

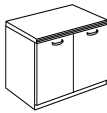

Two Door Credenza [\(See Details\)](#)

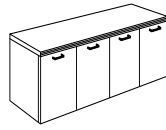

Four Door Credenza [\(See Details\)](#)

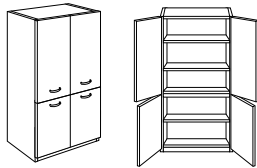

Storage Cabinet Double Doors [\(See Details\)](#)

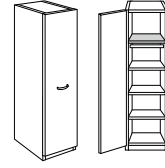

Wardrobe/Storage Cabinet [\(See Details\)](#)



Mobile Serving Cart [\(See Details\)](#)



Lectern Stand [\(See Details\)](#)

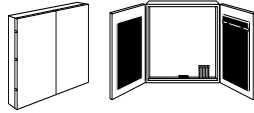

Visual Board [\(See Details\)](#)

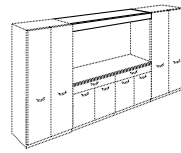

Visor Rail [\(See Details\)](#)

**Wire Management & Power/Data Accessories [\(See Multiple Unit Details\)](#)**

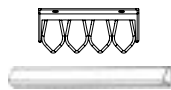

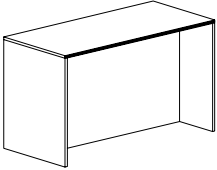
| Item   | Model No.                                       | W  | D  | H  | Ship Wt | Cubic Ft | List Price   |
|--|---|----|----|----|---------|----------|--|
| <b>WORK TABLE<br/>STANDING HEIGHT</b><br><br> | <b>48"D Units</b>                               |    |    |    |         |          |  |
|  | 65-4896TWT                                      | 96 | 48 | 42 | 402     | 14.2     | W/P\$ 3992<br><i>Wire Management Option Upcharge: \$ 784</i> |
|  | 65-4884TWT                                      | 84 | 48 | 42 | 368     | 12.4     | W/P\$ 3730<br><i>Wire Management Option Upcharge: \$ 710</i> |
|  | 65-4872TWT                                      | 72 | 48 | 42 | 332     | 10.7     | W/P\$ 3466<br><i>Wire Management Option Upcharge: \$ 630</i> |
|  | 65-4860TWT                                      | 60 | 48 | 42 | 300     | 9.0      | W/P\$ 3203<br><i>Wire Management Option Upcharge: \$ 554</i> |
|  | <b>42"D Units</b>                               |    |    |    |         |          |  |
|  | 65-4296TWT                                      | 96 | 42 | 42 | 374     | 12.5     | W/P\$ 3603<br><i>Wire Management Option Upcharge: \$ 784</i> |
|  | 65-4284TWT                                      | 84 | 42 | 42 | 342     | 10.9     | W/P\$ 3379<br><i>Wire Management Option Upcharge: \$ 710</i> |
|  | 65-4272TWT                                      | 72 | 42 | 42 | 308     | 9.4      | W/P\$ 3154<br><i>Wire Management Option Upcharge: \$ 630</i> |
|  | 65-4260TWT                                      | 60 | 42 | 42 | 278     | 7.9      | W/P\$ 2931<br><i>Wire Management Option Upcharge: \$ 554</i> |
|  | <b>36"D Units</b>                               |    |    |    |         |          |  |
|  | 65-3696TWT                                      | 96 | 36 | 42 | 346     | 10.8     | W/P\$ 3399<br><i>Wire Management Option Upcharge: \$ 784</i> |
|  | 65-3684TWT                                      | 84 | 36 | 42 | 315     | 9.5      | W/P\$ 3194<br><i>Wire Management Option Upcharge: \$ 710</i> |
|  | 65-3672TWT                                      | 72 | 36 | 42 | 283     | 8.1      | W/P\$ 2986<br><i>Wire Management Option Upcharge: \$ 630</i> |
|  | 65-3660TWT                                      | 60 | 36 | 42 | 255     | 6.8      | W/P\$ 2779<br><i>Wire Management Option Upcharge: \$ 554</i> |
|  | <b>24"D Units—Suggested Use is Against Wall</b> |    |    |    |         |          |  |
|  | 65-2496TWT<br><i>Modesty Recessed 5/4"</i>      | 96 | 24 | 42 | 211     | 64.9     | W/P\$ 3043   |
|  | 65-2484TWT<br><i>Modesty Recessed 5/4"</i>      | 84 | 24 | 42 | 193     | 57.0     | W/P\$ 2864   |
|  | 65-2472TWT<br><i>Modesty Recessed 5/4"</i>      | 72 | 24 | 42 | 176     | 49.0     | W/P\$ 2686   |
|  | 65-2460TWT<br><i>Modesty Recessed 5/4"</i>      | 60 | 24 | 42 | 158     | 41.1     | W/P\$ 2508   |

Must Specify (in this order):

Model #  
Top Material  
Finish/Color  
Edge Profile  
Chassis Color  
Modesty Color  
Grommet/Power/Data Location

**Description**

- Centered Modesty Available in Contrasting Colors
- Optional Grommets, Dock 950 Wireless Chargers, Dock 150 Wireless and USB Chargers or Power/Data Ports, [See Power Unit Options](#) and [See Locations](#)
- Double Modesty/Wire Management Upcharge will be Included when Grommet, Dock Wireless and USB Chargers, or Power/Data Ports are Ordered
- Duo/Trio and Power Data Port Units (01-DPORT4A/B) Available in PDC Locations, [See PDC Locations](#)
- 24" Deep Units Are Meant to be Used Against a Wall; Modesty Panel is Recessed 5/4"
- Ships KD; Some Assembly Required

W = Veneer P = HPL

[See Gesso Overview For Ordering Options](#)

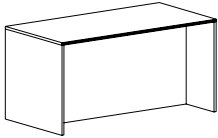
| Item   | Model No.         | W  | D  | H   | Ship Wt | Cubic Ft                                       | List Price                                     |
|--|-------------------|----|----|-----|---------|--|--|
| <b>WORK TABLE</b><br><b>STANDING HEIGHT</b><br> | <b>48"D Units</b> |    |    |     |         |  |  |
|  | 65-4896CWT        | 96 | 48 | 42  | 402     | 14.2   | W/P\$ 3812                                     |
|  |                   |    |    |     |         |  | <i>Wire Management Option Upcharge:</i> \$ 725 |
|  | 65-4884CWT        | 84 | 48 | 42  | 368     | 12.4   | W/P\$ 3562                                     |
|  |                   |    |    |     |         |  | <i>Wire Management Option Upcharge:</i> \$ 654 |
|  | 65-4872CWT        | 72 | 48 | 42  | 332     | 10.7   | W/P\$ 3308                                     |
|  |                   |    |    |     |         |  | <i>Wire Management Option Upcharge:</i> \$ 582 |
|  | 65-4860CWT        | 60 | 48 | 42  | 300     | 9.0  | W/P\$ 3057                                     |
|  |                   |    |    |     |         |  | <i>Wire Management Option Upcharge:</i> \$ 512 |
|  | <b>42"D Units</b> |    |    |     |         |  |  |
|  | 65-4296CWT        | 96 | 42 | 42  | 374     | 12.5   | W/P\$ 3437                                     |
|  |                   |    |    |     |         |  | <i>Wire Management Option Upcharge:</i> \$ 725 |
|  | 65-4284CWT        | 84 | 42 | 42  | 342     | 10.9   | W/P\$ 3225                                     |
|  |                   |    |    |     |         |  | <i>Wire Management Option Upcharge:</i> \$ 654 |
|  | 65-4272CWT        | 72 | 42 | 42  | 308     | 9.4  | W/P\$ 3009                                     |
|  |                   |    |    |     |         |  | <i>Wire Management Option Upcharge:</i> \$ 582 |
|  | 65-4260CWT        | 60 | 42 | 42  | 278     | 7.9  | W/P\$ 2795                                     |
|  |                   |    |    |     |         |  | <i>Wire Management Option Upcharge:</i> \$ 512 |
|  | <b>36"D Units</b> |    |    |     |         |  |  |
| 65-3696CWT   | 96                | 36 | 42 | 346 | 10.8    | W/P\$ 3218                                     |  |
|  |                   |    |    |     |         | <i>Wire Management Option Upcharge:</i> \$ 725 |  |
| 65-3684CWT   | 84                | 36 | 42 | 315 | 9.5     | W/P\$ 3022                                     |  |
|  |                   |    |    |     |         | <i>Wire Management Option Upcharge:</i> \$ 654 |  |
| 65-3672CWT   | 72                | 36 | 42 | 283 | 8.1     | W/P\$ 2827                                     |  |
|  |                   |    |    |     |         | <i>Wire Management Option Upcharge:</i> \$ 582 |  |
| 65-3660CWT   | 60                | 36 | 42 | 255 | 6.8     | W/P\$ 2631                                     |  |
|  |                   |    |    |     |         | <i>Wire Management Option Upcharge:</i> \$ 512 |  |
| <b>24"D Units—Suggested Use is Against Wall</b>  |                   |    |    |     |         |  |  |
| 65-2496CWT   | 96                | 24 | 42 | 211 | 64.9    | W/P\$ 2786                                     |  |
|  |                   |    |    |     |         | <i>Modesty Recessed 5¼"</i>                    |  |
| 65-2484CWT   | 84                | 24 | 42 | 193 | 57.0    | W/P\$ 2623                                     |  |
|  |                   |    |    |     |         | <i>Modesty Recessed 5¼"</i>                    |  |
| 65-2472CWT   | 72                | 24 | 42 | 176 | 49.0    | W/P\$ 2459                                     |  |
|  |                   |    |    |     |         | <i>Modesty Recessed 5¼"</i>                    |  |
| 65-2460CWT   | 60                | 24 | 42 | 158 | 41.1    | W/P\$ 2296                                     |  |
|  |                   |    |    |     |         | <i>Modesty Recessed 5¼"</i>                    |  |

**Must Specify (in this order):**

Model #  
 Top Material  
 Finish/Color  
 Edge Profile  
 Chassis Color  
 Modesty Color  
 Grommet/Power/Data Location

**Description**

- Centered Modesty Available in Contrasting Colors
- Optional Grommets, Dock 950 Wireless Chargers, Dock 150 Wireless and USB Chargers or Power/Data Ports, [See Power Unit Options](#) and [See Locations](#)
- Double Modesty/Wire Management Upcharge will be Included when Grommet, Dock Wireless and USB Chargers, or Power/Data Ports are Ordered
- Duo/Trio and Power Data Port Units (01-DPORT4A/B) Available in PDC Locations, [See PDC Locations](#)
- 24" Deep Units Are Meant to be Used Against a Wall; Modesty Panel is Recessed 5¼"
- Ships KD; Some Assembly Required

W = Veneer P = HPL

[See Gesso Overview For Ordering Options](#)

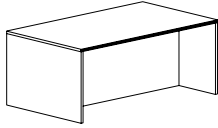
| Item   | Model No.                                       | W                 | D  | H   | Ship Wt | Cubic Ft                                       | List Price                                     |  |
|--|---|-------------------|----|-----|---------|--|--|--|
| <b>WORK TABLE</b><br><b>SEATED HEIGHT</b><br> | <b>48"D Units</b>                               |                   |    |     |         |  |  |  |
|  | 65-4896WT                                       | 96                | 48 | 30  | 326     | 14.2   | W/P\$ 2779                                     |  |
|  |   |                   |    |     |         |  | <i>Wire Management Option Upcharge:</i> \$ 654 |  |
|  | 65-4884WT                                       | 84                | 48 | 30  | 298     | 12.4   | W/P\$ 3440                                     |  |
|  |   |                   |    |     |         |  | <i>Wire Management Option Upcharge:</i> \$ 594 |  |
|  | 65-4872WT                                       | 72                | 48 | 30  | 268     | 10.7   | W/P\$ 3198                                     |  |
|  |   |                   |    |     |         |  | <i>Wire Management Option Upcharge:</i> \$ 528 |  |
|  | 65-4860WT                                       | 60                | 48 | 30  | 242     | 9.0  | W/P\$ 2954                                     |  |
|  |   |                   |    |     |         |  | <i>Wire Management Option Upcharge:</i> \$ 465 |  |
|  |   | <b>42"D Units</b> |    |     |         |  |  |  |
|  | 65-4296WT                                       | 96                | 42 | 30  | 374     | 12.5   | W/P\$ 3264                                     |  |
|  |   |                   |    |     |         |  | <i>Wire Management Option Upcharge:</i> \$ 654 |  |
| 65-4284WT  | 84  | 42                | 30 | 342 | 10.9    | W/P\$ 3063                                     |  |  |
|  |   |                   |    |     |         | <i>Wire Management Option Upcharge:</i> \$ 594 |  |  |
| 65-4272WT  | 72  | 42                | 30 | 308 | 9.4     | W/P\$ 2856                                     |  |  |
|  |   |                   |    |     |         | <i>Wire Management Option Upcharge:</i> \$ 528 |  |  |
| 65-4260WT  | 60  | 42                | 30 | 278 | 7.9     | W/P\$ 2655                                     |  |  |
|  |   |                   |    |     |         | <i>Wire Management Option Upcharge:</i> \$ 465 |  |  |
|  | <b>24"D Units—Suggested Use is Against Wall</b> |                   |    |     |         |  |  |  |
| 65-2496WT  | 96  | 24                | 30 | 173 | 47.2    | W/P\$ 2568                                     |  |  |
|  |   |                   |    |     |         | <i>Modesty Recessed 5/4"</i>                   |  |  |
| 65-2484WT  | 84  | 24                | 30 | 158 | 41.4    | W/P\$ 2423                                     |  |  |
|  |   |                   |    |     |         | <i>Modesty Recessed 5/4"</i>                   |  |  |
| 65-2472WT  | 72  | 24                | 30 | 143 | 35.6    | W/P\$ 2269                                     |  |  |
|  |   |                   |    |     |         | <i>Modesty Recessed 5/4"</i>                   |  |  |
| 65-2460WT  | 60  | 24                | 30 | 129 | 29.8    | W/P\$ 2120                                     |  |  |
|  |   |                   |    |     |         | <i>Modesty Recessed 5/4"</i>                   |  |  |

Must Specify (in this order):

Model #  
 Top Material  
 Finish/Color  
 Edge Profile  
 Chassis Color  
 Modesty Color  
 Grommet/Power/Data Location

**Description**

- Centered Modesty Available in Contrasting Colors
- Optional Grommets, Dock 950 Wireless Chargers, Dock 150 Wireless and USB Chargers or Power/Data Ports, [See Power Unit Options](#) and [See Locations](#)
- Double Modesty/Wire Management Upcharge will be Included when Grommet, Dock Wireless and USB Chargers or Power/Data Ports are Ordered
- Duo/Trio and Power Data Port Units (01-DPORT4A/B) Available in PDC Locations, [See PDC Locations](#)
- 24" Deep Units Are Meant to be Used Against a Wall; Modesty Panel is Recessed 5/4"
- Ships KD; Some Assembly Required

W = Veneer P = HPL

[See Gesso Overview For Ordering Options](#)

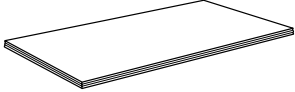
| Item   | Model No.                         | W   | D  | H                | Ship Wt | Cubic Ft | List Price           |  |
|--|-----------------------------------|-----|----|------------------|---------|----------|----------------------|--|
|  <p>RECTANGULAR TOPS</p> <p>Must Specify (in this order):<br/>           Model #<br/>           Top Material<br/>           Finish/Color<br/>           Edge Profile<br/>           Grommet/Power/Data Location</p> | <b>192" or 16' - 2 Piece Tops</b> |     |    |                  |         |          |                      |  |
|  | 97-48192RT                        | 192 | 48 | 1 $\frac{3}{16}$ | 375     | 15.5     | P\$ 6020<br>W\$ 7528 |  |
|  | <b>168" or 14' - 2 Piece Tops</b> |     |    |                  |         |          |                      |  |
|  | 97-48168RT                        | 168 | 48 | 1 $\frac{3}{16}$ | 325     | 13.6     | P\$ 5940<br>W\$ 7030 |  |
|  | <b>144" or 12' - 2 Piece Tops</b> |     |    |                  |         |          |                      |  |
|  | 97-48144RT                        | 144 | 48 | 1 $\frac{3}{16}$ | 275     | 12.3     | P\$ 5016<br>W\$ 5855 |  |
|  | <b>120" or 10' - 2 Piece Tops</b> |     |    |                  |         |          |                      |  |
|  | 97-48120RT                        | 120 | 48 | 1 $\frac{3}{16}$ | 225     | 10.3     | P\$ 4517<br>W\$ 5185 |  |
|  | <b>96" or 8' - 1 Piece Top</b>    |     |    |                  |         |          |                      |  |
|  | 97-4296RT                         | 96  | 42 | 1 $\frac{3}{16}$ | 180     | 9.4      | P\$ 3431<br>W\$ 3933 |  |
|  | <b>72" or 6' - 1 Piece Top</b>    |     |    |                  |         |          |                      |  |
|  | 97-3672RT                         | 72  | 36 | 1 $\frac{3}{16}$ | 100     | 6.2      | P\$ 2292<br>W\$ 2676 |  |

**Description**

- Grain Runs the Width of the Table
- Heavy Duty Ganging Mechanisms Connect Two (2) Piece Tops
- See Bases/Legs and Number Required For Each Top Size, [See Multiple Base Options](#); Must Order Separately
- When Using with Strut Legs, We Recommend Using Two (2) Stiffener Bars on Tops 96"W and Four (4) Stiffener Bars on Tops 144"W and Wider; Must Order Separately, [See Strut Options](#)
- Tops 120"W Do Not Need Stretcher Rails When Used with Strut Legs, the Location and Number of Strut Legs Required Offer Sufficient Support
- Optional Grommets and Power/Data; [See Location Options](#) and [See Power Units Available](#)

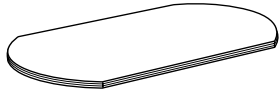
| Item   | Model No.                         | W   | D  | H                | Ship Wt | Cubic Ft | List Price           |  |
|--|-----------------------------------|-----|----|------------------|---------|----------|----------------------|--|
|  <p>ARC RECTANGULAR TOPS</p> <p>Must Specify (in this order):<br/>           Model #<br/>           Top Material<br/>           Finish/Color<br/>           Edge Profile<br/>           Grommet/Power/Data Location</p> | <b>192" or 16' - 2 Piece Tops</b> |     |    |                  |         |          |                      |  |
|  | 97-48192AR                        | 192 | 48 | 1 $\frac{3}{16}$ | 375     | 15.5     | P\$ 7202<br>W\$ 8367 |  |
|  | <b>168" or 14' - 2 Piece Tops</b> |     |    |                  |         |          |                      |  |
|  | 97-48168AR                        | 168 | 48 | 1 $\frac{3}{16}$ | 325     | 13.6     | P\$ 6860<br>W\$ 7945 |  |
|  | <b>144" or 12' - 2 Piece Tops</b> |     |    |                  |         |          |                      |  |
|  | 97-48144AR                        | 144 | 48 | 1 $\frac{3}{16}$ | 275     | 12.3     | P\$ 5771<br>W\$ 6607 |  |
|  | <b>120" or 10' - 2 Piece Tops</b> |     |    |                  |         |          |                      |  |
|  | 97-48120AR                        | 120 | 48 | 1 $\frac{3}{16}$ | 225     | 10.3     | P\$ 5434<br>W\$ 6106 |  |
|  | <b>96" or 8' - 1 Piece Top</b>    |     |    |                  |         |          |                      |  |
|  | 97-4296AR                         | 96  | 42 | 1 $\frac{3}{16}$ | 180     | 9.4      | P\$ 4098<br>W\$ 4600 |  |
|  | <b>72" or 6' - 1 Piece Top</b>    |     |    |                  |         |          |                      |  |
|  | 97-3672AR                         | 72  | 36 | 1 $\frac{3}{16}$ | 100     | 6.2      | P\$ 2676<br>W\$ 3062 |  |

**Description**

- Grain Runs the Width of the Table
- Heavy Duty Ganging Mechanisms Connect Two (2) Piece Tops
- See Bases/Legs and Number Required For Each Top Size, [See Multiple Base Options](#); Must Order Separately
- When Using with Strut Legs, We Recommend Using Two (2) Stiffener Bars on Tops 96"W and Four (4) Stiffener Bars on Tops 144"W and Wider; Must Order Separately, [See Strut Options](#)
- Tops 120"W Do Not Need Stretcher Rails When Used with Strut Legs, the Location and Number of Strut Legs Required Offer Sufficient Support
- Optional Grommets and Power/Data; [See Location Options](#) and [See Power Units Available](#)

W = Veneer P = HPL

[See Gesso Overview For Ordering Options](#)

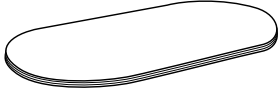
| Item  | Model No.                         | W   | D  | H                              | Ship Wt | Cubic Ft | List Price           |  |
|---|-----------------------------------|-----|----|--------------------------------|---------|----------|----------------------|--|
|  <p><b>RACETRACK TOPS</b></p> <p>Must Specify (in this order):<br/>                     Model #<br/>                     Top Material<br/>                     Finish/Color<br/>                     Edge Profile<br/>                     Grommet/Power/Data Location</p> | <b>192" or 16' - 2 Piece Tops</b> |     |    |                                |         |          |                      |  |
|   | 97-48192AT                        | 192 | 48 | 1 <sup>3</sup> / <sub>16</sub> | 375     | 15.5     | P\$ 7865<br>W\$ 9370 |  |
|   | <b>168" or 14' - 2 Piece Tops</b> |     |    |                                |         |          |                      |  |
|   | 97-48168AT                        | 168 | 48 | 1 <sup>3</sup> / <sub>16</sub> | 325     | 13.6     | P\$ 7699<br>W\$ 8785 |  |
|   | <b>144" or 12' - 2 Piece Tops</b> |     |    |                                |         |          |                      |  |
|   | 97-48144AT                        | 144 | 48 | 1 <sup>3</sup> / <sub>16</sub> | 275     | 12.3     | P\$ 6522<br>W\$ 7360 |  |
|   | <b>120" or 10' - 2 Piece Tops</b> |     |    |                                |         |          |                      |  |
|   | 97-48120AT                        | 120 | 48 | 1 <sup>3</sup> / <sub>16</sub> | 225     | 10.3     | P\$ 6020<br>W\$ 6693 |  |
|   | <b>96" or 8' - 1 Piece Top</b>    |     |    |                                |         |          |                      |  |
|   | 97-4296AT                         | 96  | 42 | 1 <sup>3</sup> / <sub>16</sub> | 180     | 9.4      | P\$ 4349<br>W\$ 4851 |  |
|   | <b>72" or 6' - 1 Piece Top</b>    |     |    |                                |         |          |                      |  |
|   | 97-3672AT                         | 72  | 36 | 1 <sup>3</sup> / <sub>16</sub> | 100     | 6.2      | P\$ 3126<br>W\$ 3513 |  |

**Description**

- Grain Runs the Width of the Table
- Heavy Duty Ganging Mechanisms Connect Two (2) Piece Tops
- See Bases/Legs and Number Required For Each Top Size, [See Multiple Base Options](#); Must Order Separately
- When Using with Strut Legs, We Recommend Using Two (2) Stiffener Bars on Tops 96"W and Four (4) Stiffener Bars on Tops 144"W and Wider; Must Order Separately, [See Strut Options](#)
- Tops 120"W Do Not Need Stretcher Rails When Used with Strut Legs, the Location and Number of Strut Legs Required Offer Sufficient Support
- Optional Grommets and Power/Data; [See Location Options](#) and [See Power Units Available](#)

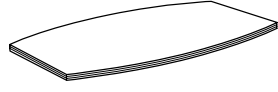
| Item  | Model No.                         | W   | D  | H                              | Ship Wt | Cubic Ft | List Price           |  |
|---|-----------------------------------|-----|----|--------------------------------|---------|----------|----------------------|--|
|  <p><b>BOAT-SHAPED TOPS</b></p> <p>Must Specify (in this order):<br/>                     Model #<br/>                     Top Material<br/>                     Finish/Color<br/>                     Edge Profile<br/>                     Grommet/Power/Data Location</p> | <b>192" or 16' - 2 Piece Tops</b> |     |    |                                |         |          |                      |  |
|   | 97-48192BT                        | 192 | 48 | 1 <sup>3</sup> / <sub>16</sub> | 375     | 15.5     | P\$ 7865<br>W\$ 9370 |  |
|   | <b>168" or 14' - 2 Piece Tops</b> |     |    |                                |         |          |                      |  |
|   | 97-48168BT                        | 168 | 48 | 1 <sup>3</sup> / <sub>16</sub> | 325     | 13.6     | P\$ 7699<br>W\$ 8785 |  |
|   | <b>144" or 12' - 2 Piece Tops</b> |     |    |                                |         |          |                      |  |
|   | 97-48144BT                        | 144 | 48 | 1 <sup>3</sup> / <sub>16</sub> | 275     | 12.3     | P\$ 6522<br>W\$ 7360 |  |
|   | <b>120" or 10' - 2 Piece Tops</b> |     |    |                                |         |          |                      |  |
|   | 97-48120BT                        | 120 | 48 | 1 <sup>3</sup> / <sub>16</sub> | 225     | 10.3     | P\$ 6020<br>W\$ 6693 |  |
|   | <b>96" or 8' - 1 Piece Top</b>    |     |    |                                |         |          |                      |  |
|   | 97-4296BT                         | 96  | 42 | 1 <sup>3</sup> / <sub>16</sub> | 180     | 9.4      | P\$ 4349<br>W\$ 4851 |  |
|   | <b>72" or 6' - 1 Piece Top</b>    |     |    |                                |         |          |                      |  |
|   | 97-3672BT                         | 72  | 36 | 1 <sup>3</sup> / <sub>16</sub> | 100     | 6.2      | P\$ 3126<br>W\$ 3513 |  |

**Description**

- Grain Runs the Width of the Table
- Heavy Duty Ganging Mechanisms Connect Two (2) Piece Tops
- See Bases/Legs and Number Required For Each Top Size, [See Multiple Base Options](#); Must Order Separately
- When Using with Strut Legs, We Recommend Using Two (2) Stiffener Bars on Tops 96"W and Four (4) Stiffener Bars on Tops 144"W and Wider; Must Order Separately, [See Strut Options](#)
- Tops 120"W Do Not Need Stretcher Rails When Used with Strut Legs, the Location and Number of Strut Legs Required Offer Sufficient Support
- Optional Grommets and Power/Data; [See Location Options](#) and [See Power Units Available](#)

W = Veneer P = HPL

[See Gesso Overview For Ordering Options](#)



| Item  | Model No.   | W  | D  | H | Ship Wt | Cubic Ft | List Price |
|---|---|----|----|---|---------|----------|------------|
|  | 65-4848CT<br><i>Accommodates Five (5) Chairs</i>  | 48 | 48 | 1 | 95      | 4.3      | W/P\$ 1215 |
|   | 65-4242CT<br><i>Accommodates Four (4) Chairs</i>  | 42 | 42 | 1 | 70      | 3.4      | W/P\$ 1174 |
|   | 65-3636CT<br><i>Accommodates Three (3) Chairs</i> | 36 | 36 | 1 | 37      | 2.5      | W/P\$ 1032 |

Must Specify (in this order):

Model #  
Top Material  
Finish/Color  
Edge Profile  
Grommet/Power/Data Location

#### Description

- Single Base or Four (4) Strut Legs (on 48" Top Only) Required; Ordered Separately, [See Below and Multiple Other Base Options](#)
- Power Options not Available

#### DISC BASE



#### For 48" Circular Tops

|            |          |    |    |                  |    |     |         |
|------------|----------|----|----|------------------|----|-----|---------|
| 01-3230DBB | Black    | 30 | 30 | 27 $\frac{3}{4}$ | 42 | 4.1 | \$ 1728 |
| 01-3230DBA | Aluminum | 30 | 30 | 27 $\frac{3}{4}$ | 42 | 4.1 | \$ 1728 |

#### For 36" and 42" Circular Tops

|            |          |    |    |                  |    |     |         |
|------------|----------|----|----|------------------|----|-----|---------|
| 01-2430DBB | Black    | 24 | 24 | 27 $\frac{3}{4}$ | 32 | 3.2 | \$ 1440 |
| 01-2430DBA | Aluminum | 24 | 24 | 27 $\frac{3}{4}$ | 32 | 3.2 | \$ 1440 |

#### Description

- 4" Diameter Column

#### METAL X-BASE

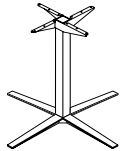

#### For 42" and 48" Circular Tops

|  |          |                  |                  |    |    |      |         |
|--|----------|------------------|------------------|----|----|------|---------|
| 08-2642LXB<br><i>For 42" High Tables</i> | Aluminum | 35 $\frac{1}{2}$ | 35 $\frac{1}{2}$ | 40 | 33 | 20.0 | \$ 1240 |
| 08-2636LXB<br><i>For 36" High Tables</i> | Aluminum | 35 $\frac{1}{2}$ | 35 $\frac{1}{2}$ | 34 | 30 | 17.2 | \$ 1196 |
| 08-2630LXB<br><i>For 30" High Tables</i> | Aluminum | 35 $\frac{1}{2}$ | 35 $\frac{1}{2}$ | 28 | 27 | 14.5 | \$ 1144 |

#### For 36" Circular Tops

|  |          |                  |                  |    |    |      |         |
|--|----------|------------------|------------------|----|----|------|---------|
| 08-2042SXB<br><i>For 42" High Tables</i> | Aluminum | 29 $\frac{1}{2}$ | 29 $\frac{1}{2}$ | 40 | 27 | 15.9 | \$ 1158 |
| 08-2036SXB<br><i>For 36" High Tables</i> | Aluminum | 29 $\frac{1}{2}$ | 29 $\frac{1}{2}$ | 34 | 24 | 13.7 | \$ 1112 |
| 08-2030SXB<br><i>For 30" High Tables</i> | Aluminum | 29 $\frac{1}{2}$ | 29 $\frac{1}{2}$ | 28 | 21 | 11.6 | \$ 1068 |

#### Description

- Not Available to Be Sold Separately

#### HEIGHT ADJUSTABLE PNEUMATIC X-BASE

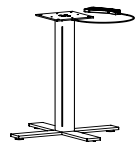

#### Maximum Round 42", Maximum Square 36"

|              |          |    |    |                     |   |     |         |
|--------------|----------|----|----|---------------------|---|-----|---------|
| 01-3232HAXBB | Black    | 32 | 32 | 26-45 $\frac{3}{4}$ | 1 | 0.2 | \$ 1615 |
| 01-3232HAXBA | Aluminum | 32 | 32 | 26-45 $\frac{3}{4}$ | 1 | 0.2 | \$ 1615 |

#### Maximum Round 36", Maximum Square 30"

|              |          |    |    |                     |   |     |         |
|--------------|----------|----|----|---------------------|---|-----|---------|
| 01-2626HAXBB | Black    | 22 | 22 | 26-45 $\frac{3}{4}$ | 1 | 0.2 | \$ 1583 |
| 01-2626HAXBA | Aluminum | 22 | 22 | 26-45 $\frac{3}{4}$ | 1 | 0.2 | \$ 1583 |

#### Description

- Pre-Drilled Boring Pattern May Not Match Underside of Table Top
- Steel Mounting Plate: 8" x 8" x  $\frac{1}{4}$ "
- Eight (8) \*MM Bolts Included for Assembly
- Ships KD

W = Veneer P = HPL

[See Gesso Overview For Ordering Options](#)

| Item       | Model No.  |          | W  | D  | H   | Ship Wt | Cubic Ft | List Price |
|------------|------------|----------|----|----|-----|---------|----------|------------|
| METAL BASE | 01-0400MBB | Black    | 32 | 32 | 27¾ | 32      | 3.2      | \$ 936     |
|            | 01-0400MBA | Aluminum | 32 | 32 | 27¾ | 32      | 3.2      | \$ 936     |



Open Market Only

Must Specify (in this order):  
Model # and Quantity

**Description**

- Shipped KD; Some Assembly Required

| Table Widths                    | Circular | 72" | 96" | 120" | 144" | 168" | 192" |
|---------------------------------|----------|-----|-----|------|------|------|------|
| <b>Number of Bases Required</b> | 1        | 2   | 2   | 3    | 3    | 3    | 3    |

**STRUT TABLE LEGS**

|             |                 |    |     |     |    |     |         |
|-------------|-----------------|----|-----|-----|----|-----|---------|
| 01-2228STR2 | 1 Pair (2 Legs) | 1½ | 22½ | 28⅝ | 32 | 4.5 | \$ 1199 |
| 01-2228STR4 | 2 Pair (4 Legs) | 1½ | 22½ | 28⅝ | 64 | 9.0 | \$ 2398 |

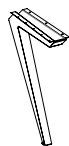

Must Specify (in this order):  
Model # and Quantity  
Color  
Stiffener Bar and Quantity

**Description**

- Available in Aluminum (ALUM) or Black (BLK); Must Specify Color
- Built-In Wire Management Cover on Inside of Legs
- Each Leg has Adjustable Glides
- Legs not Available To Be Sold Separately
- For Use with Indiana Furniture Tops Only; Not For Use with 36" or 42" Circular Tops

**Options: Specify & Add**

|            |               |  |  |  |  |  |        |
|------------|---------------|--|--|--|--|--|--------|
| 01-00048SB | Stiffener Bar |  |  |  |  |  | \$ 234 |
|------------|---------------|--|--|--|--|--|--------|

See Individual Tops for Recommended Number of Stiffener Bars

| Table Widths                    | 48" CT | 72" | 96" | 120" | 144" | 168" * | 192" |
|---------------------------------|--------|-----|-----|------|------|--------|------|
| <b>Number of Bases Required</b> | 4      | 4   | 4   | 6    | 6    | 8      | 8    |

\*168" Racetrack Tops Require 6 Bases

**CYLINDER BASE**

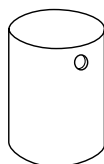

| For Tables 42"D to 48"D |  |  |    |    |     |     |      |          |
|-------------------------|--|--|----|----|-----|-----|------|----------|
| 01-2020CB               |  |  | 20 | 20 | 28½ | 136 | 10.9 | W\$ 1456 |
| For Tables 36"D         |  |  |    |    |     |     |      |          |
| 01-1616CB               |  |  | 16 | 16 | 28½ | 101 | 7.2  | W\$ 1331 |

**Description**

- Veneer Cylinder Base Features Multi-Step, Hand-Finished Catalyzed Finish
- Weighted for Stability
- Two (2) Wire Management Black Grommets Standard at Top Edge; 8" Wire Management Opening Standard at Bottom
- See Number of Bases Required Per Table Width Below

**Additional Grommet Options: Specify & Add**

|       |                                  |  |  |  |  |  |    |     |
|-------|----------------------------------|--|--|--|--|--|----|-----|
| GCB1S | Only One (1) Grommet At Top Edge |  |  |  |  |  | \$ | N/C |
| NOGC  | No Grommets At Top Edge          |  |  |  |  |  | \$ | N/C |

| Table Widths                    | Circular | 72" | 96" | 120" | 144" | 168" | 192" |
|---------------------------------|----------|-----|-----|------|------|------|------|
| <b>Number of Bases Required</b> | 1        | 2   | 2   | 3    | 3    | 3    | 3    |

Must Specify (in this order):  
Model # and Quantity  
Finish  
Grommet Options

W = Veneer P = HPL

[See Gesso Overview For Ordering Options](#)

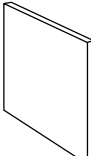
| Item  | Model No.                      | W  | D | H   | Ship Wt | Cubic Ft | List Price |
|---|--------------------------------|----|---|-----|---------|----------|------------|
| RECTANGULAR PANEL BASE<br> | <b>For Tables 48"D</b>         |    |   |     |         |          |            |
|   | 01-2428RBV                     | 24 | 2 | 28½ | 34      | 2.7      | W\$ 1023   |
|   | <b>For Tables 36"D to 42"D</b> |    |   |     |         |          |            |
|   | 01-2028RBV                     | 20 | 2 | 28½ | 28      | 2.3      | W\$ 957    |

Must Specify (in this order):

- Model # and Quantity
- Finish
- Stretcher Rail

**Description**

- Stretcher Rails Included; Specify Model (See Below)
- Also Available with Arch Stretcher Rails; Sold Separately
- See Number of Bases Required Per Table Width Below

| Table Widths                      | 72"      | 96"      | 120"      | 144"      | 168"      | 192"      |
|-----------------------------------|----------|----------|-----------|-----------|-----------|-----------|
| <b>Number of Bases Required</b>   | 2        | 2        | 3         | 3         | 3         | 5         |
| <b>Stretcher Rails (Included)</b> | 01-72STR | 01-96STR | 01-120STR | 01-144STR | 01-168STR | 01-192STR |

**ARCH STRETCHER RAILS**

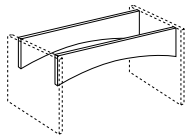

|             |     |   |        |    |     |          |
|-------------|-----|---|--------|----|-----|----------|
| 01-192ARCHV | 192 | ¾ | 8 - 12 | 77 | 4.2 | W\$ 2426 |
| 01-168ARCHV | 168 | ¾ | 8 - 12 | 68 | 4.2 | W\$ 1511 |
| 01-144ARCHV | 144 | ¾ | 8 - 12 | 57 | 4.2 | W\$ 1382 |
| 01-120ARCHV | 120 | ¾ | 8 - 12 | 46 | 4.2 | W\$ 1276 |
| 01-96ARCHV  | 96  | ¾ | 8 - 12 | 35 | 4.2 | W\$ 864  |
| 01-72ARCHV  | 72  | ¾ | 8 - 12 | 28 | 4.2 | W\$ 778  |

Must Specify (in this order):

- Model # and Quantity
- Finish

**Description**

- For Use With Rectangular Bases; 01-2428RBV or 01-2028RBV
- Must Be Field Installed in Place of the Standard Stretcher Rails Shipped with Rectangular Bases
- Rails for Tables 120" to 168" will Ship as Two (2) Sets of Two (2)
- Rails for Tables 192" will Ship as Four (4) Sets of Two (2)

**RECTANGULAR BOX BASE WITH DOOR**

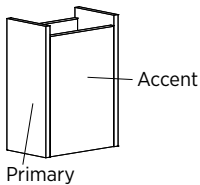

|             |    |    |     |    |     |         |
|-------------|----|----|-----|----|-----|---------|
| 01-1220RBDV | 20 | 12 | 28½ | 50 | 5.4 | W\$ 825 |
|             |    |    |     |    |     | C\$ 800 |

**Description**

- Rectangular Base with Lift-Off Removable Panel
- Available in Veneer, or a Combination of Veneer and Laminate; Must Specify Color ([See Color Options](#))
- Must Indicate Accent Selection and Primary Selection on Order
- 2" Wire Management Access Across Both Sides
- Fully Open for Wire Management at the Bottom

Must Specify (in this order):

- Model # and Quantity
- Primary Finish/Color
- Accent Finish/Color

| Table Widths                    | 72" | 96" | 120" | 144" | 168" | 192" |
|---------------------------------|-----|-----|------|------|------|------|
| <b>Number of Bases Required</b> | 2   | 2   | 3    | 3    | 3    | 3    |

W = Veneer C = Combination Laminate and Veneer

[See Gesso Overview For Ordering Options](#)

| Item | Model No. | W | D | H | Ship Wt | Cubic Ft | List Price |
|------|-----------|---|---|---|---------|----------|------------|
|------|-----------|---|---|---|---------|----------|------------|

|            |                                |    |    |     |    |     |          |
|------------|--------------------------------|----|----|-----|----|-----|----------|
| CANOE BASE | 01-1222CS                      | 22 | 12 | 28½ | 27 | 5.8 | W\$ 3340 |
|            | 01-1222CSD<br><i>With Door</i> | 22 | 12 | 28½ | 27 | 5.8 | W\$ 3876 |

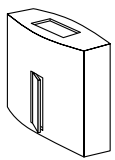

Shown With Door

Must Specify (in this order):

- Model # and Quantity
- Finish
- Grommet Options

**Description**

- Veneer Base Features Multi-Step, Hand-Finished Catalyzed Finish
- Two (2) Wire Management Black Grommets Standard at Top Edge; 6" Wire Management Opening in the Bottom
- Models with Doors Have a 18"H x 6"W Opening (Does Not Feature Soft Close Hinges)
- Adjustable Levelers

**Additional Grommet Options: Specify & Add**

|       |                             |    |     |
|-------|-----------------------------|----|-----|
| GCBIS | One (1) Grommet At Top Edge | \$ | N/C |
| NOGC  | No Grommets At Top Edge     | \$ | N/C |

|                                 |            |            |             |             |             |             |
|---------------------------------|------------|------------|-------------|-------------|-------------|-------------|
| <b>Table Widths</b>             | <b>72"</b> | <b>96"</b> | <b>120"</b> | <b>144"</b> | <b>168"</b> | <b>192"</b> |
| <b>Number of Bases Required</b> | 2          | 2          | 3           | 3           | 3           | 3           |

|                     |             |     |   |     |    |     |          |
|---------------------|-------------|-----|---|-----|----|-----|----------|
| V-CAPPED PANEL BASE | 01-0430VPBV | 30½ | 6 | 27¾ | 28 | 3.5 | W\$ 2031 |
|---------------------|-------------|-----|---|-----|----|-----|----------|

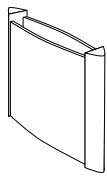

Must Specify (in this order):

- Model # and Quantity
- Finish
- Metal Finish

**Description**

- Metal V-Cap Accents Veneer Panel Base
- Select From Five (5) Powdercoat Finishes; [See Color Options](#)
- 3" Wire Access Across the Top
- Fully Open for Wire Management at the Bottom
- Adjustable Levelers

|                                 |            |            |             |             |             |             |
|---------------------------------|------------|------------|-------------|-------------|-------------|-------------|
| <b>Table Widths</b>             | <b>72"</b> | <b>96"</b> | <b>120"</b> | <b>144"</b> | <b>168"</b> | <b>192"</b> |
| <b>Number of Bases Required</b> | 2          | 2          | 3           | 3           | 3           | 5           |

|                        |             |     |   |     |    |     |          |
|------------------------|-------------|-----|---|-----|----|-----|----------|
| FLAT-CAPPED PANEL BASE | 01-0427FPBV | 27¾ | 4 | 27¾ | 31 | 3.5 | W\$ 2086 |
|------------------------|-------------|-----|---|-----|----|-----|----------|

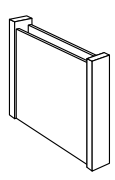

Must Specify (in this order):

- Model # and Quantity
- Finish
- Metal Finish

**Description**

- Metal Flat-Cap Accents Veneer Panel Base
- Select From Five (5) Powdercoat Finishes; [See Color Options](#)
- 3" Wire Access Across the Top
- Fully Open for Wire Management at the Bottom
- Adjustable Levelers

|                                 |            |            |             |             |             |             |
|---------------------------------|------------|------------|-------------|-------------|-------------|-------------|
| <b>Table Widths</b>             | <b>72"</b> | <b>96"</b> | <b>120"</b> | <b>144"</b> | <b>168"</b> | <b>192"</b> |
| <b>Number of Bases Required</b> | 2          | 2          | 3           | 3           | 3           | 5           |

W = Veneer C = Combination Laminate and Laminate

| Item                               | Model No. | W  | D  | H  | Ship Wt | Cubic Ft | List Price           |
|------------------------------------|-----------|----|----|----|---------|----------|----------------------|
| <b>TWO DOOR BUFFET WITH DRAWER</b> | 97-2436BF | 36 | 24 | 36 | 189     | 21.7     | P\$ 3887<br>W\$ 3951 |

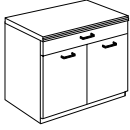
**Description**

- Top Edge Profiled on Approach Side Only; Must Specify Edge Selection
- One (1) Drawer with Storage Behind Two (2) Veneer Doors and One (1) Adjustable Shelf

Must Specify (in this order):

Model #  
Top Material  
Finish/Color  
Edge Profile  
Pull

|  |           |    |    |    |     |      |                      |
|--|-----------|----|----|----|-----|------|----------------------|
| <b>FOUR DOOR BUFFET WITH TWO DRAWERS</b> | 97-2472BF | 72 | 24 | 36 | 342 | 45.6 | P\$ 7600<br>W\$ 7716 |
|--|-----------|----|----|----|-----|------|----------------------|

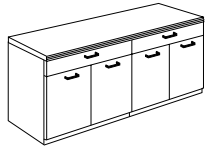
**Description**

- Top Edge Profiled on Approach Side Only; Must Specify Edge Selection
- Two (2) Drawers with Storage Behind Four (4) Doors and Two (2) Adjustable Shelves

Must Specify (in this order):

Model #  
Top Material  
Finish/Color  
Edge Profile  
Pull

|   |            |    |    |    |     |      |                      |
|---|------------|----|----|----|-----|------|----------------------|
| <b>FOUR DOOR BUFFET WITH TWO DRAWERS AND OPEN STORAGE</b> | 97-2472BFD | 72 | 24 | 36 | 337 | 45.6 | P\$ 8450<br>W\$ 8563 |
|---|------------|----|----|----|-----|------|----------------------|

**Description**

- Top Edge Profiled on Approach Side Only; Must Specify Edge Selection
- Open Storage with One (1) Adjustable Shelf
- Two (2) Drawers
- Left and Right Storage Behind Doors with One (1) Adjustable Shelf
- Storage Behind Center Doors

Must Specify (in this order):

Model #  
Top Material  
Finish/Color  
Edge Profile  
Pull

|  |            |    |    |    |     |      |                      |
|--|------------|----|----|----|-----|------|----------------------|
| <b>FOUR DOOR BUFFET WITH THREE DRAWERS</b> | 97-2472SBF | 72 | 24 | 36 | 362 | 45.6 | P\$ 8450<br>W\$ 8563 |
|--|------------|----|----|----|-----|------|----------------------|

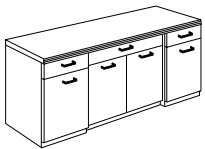
**Description**

- Top Edge Profiled on Approach Side Only; Must Specify Edge Selection
- Three (3) Drawers with Storage Behind Four (4) Doors with Three (3) Adjustable Shelves
- Center Section is Stepped Back

Must Specify (in this order):

Model #  
Top Material  
Finish/Color  
Edge Profile  
Pull

W = Veneer P = HPL

[See Gesso Overview For Ordering Options](#)

| Item                     | Model No. | W  | D  | H  | Ship Wt | Cubic Ft | List Price           |
|--------------------------|-----------|----|----|----|---------|----------|----------------------|
| <b>TWO DOOR CREDENZA</b> | 97-2436CC | 36 | 24 | 30 | 150     | 17.6     | P\$ 3043<br>W\$ 3106 |

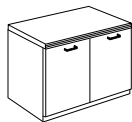

Must Specify (in this order):

- Model #
- Top Material
- Finish/Color
- Edge Profile
- Pull
- Locking Option

**Description**

- Top Edge Profiled on Approach Side Only; Must Specify Edge Selection
- Two Doors (2) Adjustable Shelf Behind Doors
- Additional Option: Locking Doors ([See Locking Options](#))

|                           |           |    |    |    |     |      |                      |
|---------------------------|-----------|----|----|----|-----|------|----------------------|
| <b>FOUR DOOR CREDENZA</b> | 97-2472CC | 72 | 24 | 30 | 290 | 34.2 | P\$ 6003<br>W\$ 6115 |
|---------------------------|-----------|----|----|----|-----|------|----------------------|

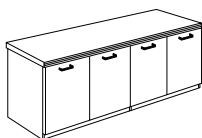

Must Specify (in this order):

- Model #
- Top Material
- Finish/Color
- Edge Profile
- Pull
- Locking Option

**Description**

- Top Edge Profiled on Approach Side Only; Must Specify Edge Selection
- Four (4) Doors with Two (2) Adjustable Shelves Behind Doors
- Additional Option: Locking Doors ([See Locking Options](#))

|                                    |            |    |    |                                  |     |      |          |
|------------------------------------|------------|----|----|----------------------------------|-----|------|----------|
| <b>DOUBLE DOOR STORAGE CABINET</b> | 97-3672SUD | 36 | 24 | 70 <sup>13</sup> / <sub>16</sub> | 285 | 42.0 | W\$ 7091 |
|------------------------------------|------------|----|----|----------------------------------|-----|------|----------|

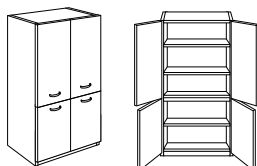

Must Specify (in this order):

- Model #
- Finish
- Pull

**Description**

- Top Section has Two (2) Adjustable Shelves; Bottom Section has One (1) Adjustable Shelf

| WARDROBE/STORAGE CABINET | HINGED LEFT | HINGED RIGHT | W | D | H | Ship Wt | Cubic Ft | List Price |
|--------------------------|-------------|--------------|---|---|---|---------|----------|------------|
|                          | 97-1872WL   | 97-1872WR    |   |   |   |         |          |            |

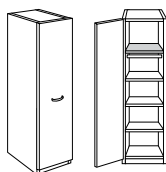

Shown as Left

Must Specify (in this order):

- Model #
- Finish
- Pull

**Description**

- Fixed Top Shelf; Coat Rod Under Fixed Shelf
- Three (3) Adjustable Shelves Behind Door
- Adjustable Shelves can be Removed for Wardrobe Application

W = Veneer P = HPL

[See Gesso Overview For Ordering Options](#)

| Item       | Model No. | W  | D  | H                | Ship Wt | Cubic Ft | List Price |
|------------|-----------|----|----|------------------|---------|----------|------------|
| VISOR RAIL | 97-2472VR | 72 | 24 | 5 $\frac{3}{16}$ | 100     | 8.9      | W\$ 1362   |

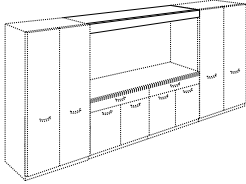

Must Specify (in this order):

Model #  
Finish  
Projection Screen  
Task Light

**Description**

- Overhead Rail Creates Wall Unit
- For Use with 72" High Cabinets and Credenzas/Bufets (Ordered Separately)

**Options: Specify & Add**

|         |   |        |
|---------|---|--------|
| 1-PS    | Projection Screen (Requires Field Installation) | \$ 996 |
| TL-0848 | Task Light (Requires Field Installation)        | \$ 417 |

|              |           |    |    |    |     |      |                      |
|--------------|-----------|----|----|----|-----|------|----------------------|
| SERVING CART | 97-2436SV | 36 | 24 | 36 | 149 | 24.0 | P\$ 4408<br>W\$ 4471 |
|--------------|-----------|----|----|----|-----|------|----------------------|



Must Specify (in this order):

Model #  
Top Material  
Finish/Color  
Edge Profile  
Pull  
Grommet Options

**Description**

- Top Edge Profiled on Approach Side Only; Must Specify Edge Selection
- Two (2) Box Drawers
- Open Storage with Storage Behind Two (2) Doors
- Locking Casters

**Grommet Option: Specify & Add**

|        |   |       |
|--------|---|-------|
| 1-GRMT | Grommet in Back Panel; Must Specify Black or Silver | \$ 72 |
|--------|---|-------|

|               |           |    |    |    |     |      |          |
|---------------|-----------|----|----|----|-----|------|----------|
| LECTERN STAND | 97-2650LS | 26 | 24 | 50 | 130 | 21.9 | W\$ 3621 |
|---------------|-----------|----|----|----|-----|------|----------|

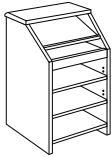

Must Specify (in this order):

Model #  
Finish  
Edge Profile

**Description**

- Top Edge Profiled on Approach Side Only; Must Specify Edge Selection
- Fixed Reading Shelf
- Pullout Shelf
- Two (2) Adjustable Storage Shelves in Lower Compartment
- Two (2) Locking and Two Non-Locking Casters
- Wire Management Grommet in Bottom Shelf

|              |           |    |   |    |     |      |          |
|--------------|-----------|----|---|----|-----|------|----------|
| VISUAL BOARD | 97-4848VB | 48 | 5 | 48 | 150 | 11.0 | W\$ 4604 |
|--------------|-----------|----|---|----|-----|------|----------|

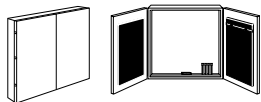

Must Specify (in this order):

Model #  
Finish  
Tackboard Fabric  
Project Screen

**Description**

- Tackboard on Each Door Standard in Black Fabric Unless Specified; Price Valid for Grades 1, 2, & 3 (See Other Pricing Below)
- Display Rail with Adjustable Hooks for Flipchart
- Magnetic Porcelain Non-Glare Writing Surface
- Includes Flipchart, Set of Four (4) Dry Erase Markers and Eraser, Mounting Hardware
- Does Not Feature Soft Close Hinges
- Studio Pull Not Available

**Options: Specify & Add**

|                         | Grade 4   | Grade 5 | Grade 6 | Grade 7 | Grade 8 | Grade 9 | Grade 10 |
|-------------------------|---|---------|---------|---------|---------|---------|----------|
| Tackboard Fabric Change | \$ 260  | 382     | 506     | 684     | 866     | 1082    | 1328     |
| 1-PS                    | Projection Screen (Requires Field Installation) |         |         |         |         |         | \$ 996   |

W = Veneer P = HPL

[See Gesso Overview For Ordering Options](#)

| Item                     | Model No.    | W  | D   | H  | Ship Wt | Cubic Ft | List Price |
|--------------------------|--------------|----|-----|----|---------|----------|------------|
| TABLE POWER & DATA VAULT | 01-CVAULTG2A | 4½ | 15⅞ | 4⅞ | 10      | 0.4      | \$ 1823    |



Open Market Only

**Description**

- Electric Drive Motor Rotates the Surface Technology 180° to the Proper Position
- Photo-Electronic Eye Prevents Rotation When Obstructed
- Two (2) Data Ports, Three (3) Power Outlets, and One (1) HDMI and Two (2) 5V USB
- 6' Power Cord
- UL and CSA Recognized

|                          |             |          |     |    |    |    |     |         |
|--------------------------|-------------|----------|-----|----|----|----|-----|---------|
| WORKSURFACE POWER CENTER | 01-INTRFC1A | Aluminum | 14¼ | 6⅝ | 2⅞ | 11 | 0.3 | \$ 1936 |
|                          | 01-INTRFC1B | Black    |     |    |    |    |     |         |

**Description**

- For Use with Conference Tables
- Four (4) Power Outlets, Three (3) Telecom Plate Openings
- Two (2) Telecom Plates Included with the Unit: One (1) 01-ABLAB Plate (Consists of One (1) RJ45 Cat 6, One (1) RJ11 Cat 3 Phone Jack); One (1) 01-ABLBB Plate (Consists of Two (2) RJ45 Cat 6)
- 6' Power Cord
- Convenience Plug on Bottom
- UL Listed/CSA Certified
- Additional Telecom Plates, [See Telecom Plate Options](#)

|                         |            |          |     |    |    |    |     |         |
|-------------------------|------------|----------|-----|----|----|----|-----|---------|
| OASIS MINI POWER & DATA | 01-OASISMA | Aluminum | 14¼ | 6⅝ | 2⅞ | 11 | 0.3 | \$ 2993 |
|                         | 01-OASISMB | Black    |     |    |    |    |     |         |

**Description**

- For Use with Conference Tables
- Soft Touch Hinged Lid
- Four (4) Power Outlets, Three (3) Telecom Plate Openings
- Two (2) Telecom Plates Included with the Unit: One (1) 01-ABLAB Plate (Consists of One (1) RJ45 Cat 6, One (1) RJ11 Cat 3 Phone Jack); One (1) 01-ABLB Plate (Consists of One (1) RJ45 Cat 6)
- 9' Power Cord
- UL Listed
- Additional Telecom Plates, [See Telecom Plate Options](#)





|                       |                |          |   |    |    |   |     |        |
|-----------------------|----------------|----------|---|----|----|---|-----|--------|
| INTERACT POWER & DATA | 01-INTERACTG2A | Aluminum | 9 | 5⅝ | 2¾ | 5 | 0.2 | \$ 836 |
|                       | 01-INTERACTG2B | Black    |   |    |    |   |     |        |

**Description**

- Includes: Two (2) Power Outlets, Two (2) USB-A Charging Ports, One (1) Telecom Plate Opening; Two (2) Keystone Openings for Voice/Data Jacks
- One (1) Telecom Plates Included with the Unit: One (1) 01-ABLAB Plate (Consists of One (1) RJ45 Cat 6, One (1) RJ11 Cat 3 Phone Jack)
- Convenience Plug on Bottom
- 6' Power Cord
- UL and CSA Recognized
- Additional Telecom Plates, [See Telecom Plate Options](#)

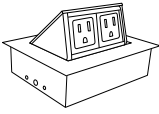
[See Gesso Overview For Ordering Options](#)

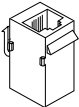

| Item  | Model No.   |          | W                | D               | H | Ship Wt | Cubic Ft | List Price |
|---|-------------|----------|------------------|-----------------|---|---------|----------|------------|
| <b>POWER 440</b><br>   | 01-DATA440A | Aluminum | 5 $\frac{5}{16}$ | 4 $\frac{3}{8}$ | - | 5       | 0.2      | \$ 904     |
|   | 01-DATA440B | Black    |                  |                 |   |         |          | \$ 904     |
| <b>Description</b> <ul style="list-style-type: none"> <li>• Two (2) Power Outlets</li> <li>• Soft Touch Hinged Lid</li> <li>• 6' Power Cord</li> <li>• UL and CSA Recognized</li> </ul>   |             |          |                  |                 |   |         |          |            |
| <b>POWER DATA PORT</b><br>   | 01-DPORT4A  | Aluminum | 8                | 4               | - | 7       | 0.2      | \$ 1025    |
|   | 01-DPORT4B  | Black    |                  |                 |   |         |          | \$ 1025    |
| <b>Description</b> <ul style="list-style-type: none"> <li>• Retracts into Work Surface to Regain Productive Space; One-Touch Access to Power and Data</li> <li>• Two (2) Power Outlets and Two (2) Open Ports for Data</li> <li>• Optional Telecom Port Components, See Below</li> <li>• Water-Proof Simplex (Outlets)</li> <li>• Includes a Voice/Data Adapter Kit to Accept Couplers and Jacks When Required</li> <li>• 6' Power Cord</li> <li>• UL and CSA Recognized</li> </ul> |             |          |                  |                 |   |         |          |            |
| <b>USB PORT</b><br>  | 01-USBPORT  |          | -                | -               | - | -       | -        | \$ 151     |
| <b>Description</b> <ul style="list-style-type: none"> <li>• Increases Transfer Speed Up to Five (5) gbs/sec</li> <li>• Simultaneous Read/Write Capability; Idle Device Power Saving State</li> <li>• 6' Cord</li> <li>• Compatible with 01-DPORT4A and 01-DPORT4B</li> </ul>  |             |          |                  |                 |   |         |          |            |
| <b>VOICE COUPLER</b><br>   | 01-VOICE1   |          | -                | -               | - | -       | -        | \$ 69      |
| <b>Description</b> <ul style="list-style-type: none"> <li>• 6-Pin Modular Plug</li> <li>• Molded Black; Cord Not included</li> <li>• Compatible with 01-DPORT4A and 01-DPORT4B</li> </ul>   |             |          |                  |                 |   |         |          |            |
| <b>DATA PORT</b><br>   | 01-RJ4DATA  |          | -                | -               | - | -       | -        | \$ 156     |
| <b>Description</b> <ul style="list-style-type: none"> <li>• 8-Pin Modular Plug; Cat 5 Ethernet Cable; Pre-terminated Cable</li> <li>• 9' Cord</li> <li>• Compatible with 01-DPORT4A and 01-DPORT4B</li> </ul>   |             |          |                  |                 |   |         |          |            |

[See Gesso Overview For Ordering Options](#)

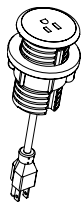
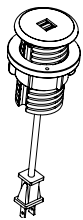
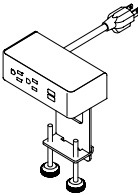
| Item  | Model No.  |        | W                 | D                 | H | Ship Wt | Cubic Ft | List Price |
|---|--|--------|-------------------|-------------------|---|---------|----------|------------|
| ROUND GROMMET COVER<br>            | 01-GRMTB   | Black  | 2 $\frac{3}{8}$ " | 2 $\frac{3}{8}$ " | - | 1       | 0.1      | \$ 33      |
|   | 01-GRMTSL  | Silver |                   |                   |   |         |          | \$ 33      |
|   | <i>Open Market Only</i>  |        |                   |                   |   |         |          |            |
|   | <b>Description</b>   |        |                   |                   |   |         |          |            |
|   | <ul style="list-style-type: none"> <li>• 2<math>\frac{3}{8}</math>" (60mm) Round Grommet Cover</li> <li>• Field Installed</li> </ul>   |        |                   |                   |   |         |          |            |
| SINGLE POWER SAND DOLLAR<br>       | 01-SAND60PS  | Silver | 3                 | 3                 | 4 | 1       | 0.2      | \$ 92      |
|   | 01-SAND60PW  | White  |                   |                   |   |         |          | \$ 92      |
|   | 01-SAND60PB  | Black  |                   |                   |   |         |          | \$ 92      |
|   | <b>Description</b>   |        |                   |                   |   |         |          |            |
|   | <ul style="list-style-type: none"> <li>• Mounts in 2<math>\frac{3}{8}</math>" (60mm) Round Grommet</li> <li>• Single Power Outlet with 6' Cord</li> </ul>  |        |                   |                   |   |         |          |            |
| DOUBLE USB SAND DOLLAR<br>       | 01-SAND60US  | Silver | 3                 | 3                 | 4 | 1       | 0.2      | \$ 260     |
|   | 01-SAND60UW  | White  |                   |                   |   |         |          | \$ 260     |
|   | 01-SAND60UB  | Black  |                   |                   |   |         |          | \$ 260     |
|   | <b>Description</b>   |        |                   |                   |   |         |          |            |
|   | <ul style="list-style-type: none"> <li>• Mounts in 2<math>\frac{3}{8}</math>" (60mm) Round Grommet</li> <li>• Dual USB Outlets with 6' Cord</li> </ul>   |        |                   |                   |   |         |          |            |
| DUO BEZEL CLAMP<br>NEMA PLUG<br> | 01-DUOCLAMPS   | Silver | 5 $\frac{1}{2}$ " | 3                 | 7 | 1       | 0.2      | \$ 537     |
|   | 01-DUOCLAMPW   | White  |                   |                   |   |         |          | \$ 537     |
|   | 01-DUOCLAMPB   | Black  |                   |                   |   |         |          | \$ 537     |
|   | <b>Description</b>   |        |                   |                   |   |         |          |            |
|   | <ul style="list-style-type: none"> <li>• Standard with: Two (2) Power Outlet, Two (2) USB Ports, 10' Cord</li> <li>• Clamps to Top and Features Silver Metal Trim</li> <li>• Independent USB Circuit Controllers Deliver up to 2.1 Amps to Each Post</li> <li>• All Mounting Hardware Included</li> <li>• FCC Part 15A and UL Approved for Horizontal and Vertical Applications</li> </ul> |        |                   |                   |   |         |          |            |

[See Gesso Overview For Ordering Options](#)

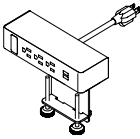
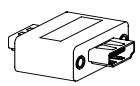
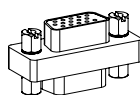
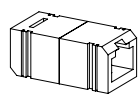
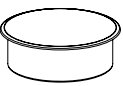
| Item   | Model No.     |        | W                  | D                  | H | Ship Wt | Cubic Ft | List Price |
|--|---------------|--------|--------------------|--------------------|---|---------|----------|------------|
| <b>TRIO BEZEL CLAMP NEMA PLUG</b><br>   | 01-TRIOCLAMPS | Silver | 8                  | 3                  | 7 | 1       | 0.2      | \$ 629     |
|  | 01-TRIOCLAMPW | White  |                    |                    |   |         |          | \$ 629     |
|  | 01-TRIOCLAMPS | Black  |                    |                    |   |         |          | \$ 629     |
| <b>Description</b> <ul style="list-style-type: none"> <li>• Standard with: Three (3) Power Outlets, Two (2) USB Ports, One (1) Open Data, 10' Cord</li> <li>• Clamps to Top and Features Silver Metal Trim</li> <li>• Independent USB Circuit Controllers Deliver up to 2.1 Amps to Each Post</li> <li>• HDMI, VGA, or RJ45 Accessories Sold Separately, See Below</li> <li>• All Mounting Hardware Included</li> <li>• FCC Part 15A and UL Approved for Horizontal and Vertical Applications</li> </ul> |               |        |                    |                    |   |         |          |            |
| <b>HDMI DATA PORT ACCESSORY FOR TRIO UNITS</b><br> <p>Open Market</p>   | 01-LCOMHDMI   |        | -                  | -                  | - | 1       | 0.2      | \$ 155     |
| <b>Description</b> <ul style="list-style-type: none"> <li>• HDMI Port for Trio Units</li> </ul>  |               |        |                    |                    |   |         |          |            |
| <b>VGA DATA PORT ACCESSORY FOR TRIO UNITS</b><br>   | 01-LCOMVGA    |        | -                  | -                  | - | 1       | 0.2      | \$ 114     |
| <b>Description</b> <ul style="list-style-type: none"> <li>• VGA Port for Trio Units</li> </ul>   |               |        |                    |                    |   |         |          |            |
| <b>RJ45 DATA PORT ACCESSORY FOR TRIO UNITS</b><br>  | 01-LCOMRJ45   |        | -                  | -                  | - | 1       | 0.2      | \$ 74      |
| <b>Description</b> <ul style="list-style-type: none"> <li>• RJ45 Port for Trio Units</li> </ul>  |               |        |                    |                    |   |         |          |            |
| <b>DOCK 950 WIRELESS CHARGER</b><br> <p>Open Market Only</p>  | 01-DOCK950W   | White  | 3 $\frac{3}{16}$ " | 3 $\frac{3}{16}$ " | - | 1       | 0.2      | \$ 249     |
|  | 01-DOCK950B   | Black  |                    |                    |   |         |          | \$ 249     |
| <b>Description</b> <ul style="list-style-type: none"> <li>• For Use with Wireless Charging Enabled Devices</li> <li>• 5 Watts Maximum Output with a Direct Current of 5V 2A and 10 Watts Maximum with Quick Charge 2.0</li> <li>• Mounts in 76mm Round Cut-Out</li> <li>• LED will Confirm Pairing with Device and Begin Wireless Charging</li> </ul>  |               |        |                    |                    |   |         |          |            |

[See Gesso Overview For Ordering Options](#)

| Item                     | Model No.   |       | W | D | H | Ship Wt | Cubic Ft | List Price |
|--------------------------|-------------|-------|---|---|---|---------|----------|------------|
| WIRELESS AND USB CHARGER | 01-DOCK150W | White | 3 | 3 | ¾ | 1       | 0.2      | \$ 380     |
|                          | 01-DOCK150B | Black |   |   |   |         |          | \$ 380     |



Open Market Only

#### Description

- For Use with Wireless Charging Enabled Devices and USB Charging Devices
- 5 Watt Maximum Output with a Direct Current Input of 5V 6A (Wireless Fast Charge)
- Mounts in 76mm Round Cut-Out
- Pop-Up is ¾"H and Includes Three (3) USB Ports; One (1) 12 Watt Maximum with 2.4A (USB Fast Charge) and Two (2) 5 Watt with 1A (USB Standard Charge)
- LED Light will Confirm Pairing with Device and Begin Wireless Charging
- UL and cUL Certified

|                    |          |  |     |    |     |    |     |         |
|--------------------|----------|--|-----|----|-----|----|-----|---------|
| VESTA POWER CENTER | 01-PDCTR |  | 10¾ | 12 | 28¾ | 14 | 2.5 | \$ 1666 |
|--------------------|----------|--|-----|----|-----|----|-----|---------|

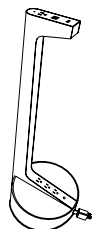

#### Description

- Top Includes One (1) Power Outlet, Two (2) USB Ports and One (1) USBC Port; Base Includes Three (3) Outlet
- Available in White
- 120" Power Cord
- Built with Weight Distribution for Optimal Stability
- Base is 5" Tall

|             |         |  |   |   |   |   |   |        |
|-------------|---------|--|---|---|---|---|---|--------|
| POWER STRIP | 01-PRSP |  | 9 | 2 | 2 | 1 | - | \$ 192 |
|-------------|---------|--|---|---|---|---|---|--------|



#### Description

- Includes Four (4) Outlets and Two (2) Phone Jacks
- Black Plastic with Rocker On/Off Switch
- 13 Amp Circuit Breaker
- 10' Power Cord and Two (2) 14' Phone Hook Up Cords
- UL Listed and CSA Certified
- Suitable for Surface or Recessed Mounting
- Ships via UPS Only

|                         |          |  |    |    |   |   |   |        |
|-------------------------|----------|--|----|----|---|---|---|--------|
| WIRE MANAGEMENT CHANNEL | 01-WMGR4 |  | 16 | 1½ | ¾ | 1 | - | \$ 109 |
|-------------------------|----------|--|----|----|---|---|---|--------|

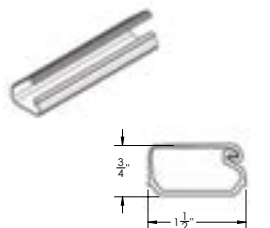

#### Description

- Set of Four (4) Black Plastic Wire Management Channels
- Snap Lock Channel
- Attaches with Adhesive Strips
- Ships via UPS Only

|            |           |  |    |    |   |   |   |       |
|------------|-----------|--|----|----|---|---|---|-------|
| CABLE GRIP | 01-WMGRCB |  | 5¾ | 2¾ | - | - | - | \$ 16 |
|------------|-----------|--|----|----|---|---|---|-------|

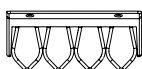

#### Description

- Under Surface Wire Management
- Black

[See Gesso Overview For Ordering Options](#)

| Item   | Model No.     | W  | D | H | Ship Wt | Cubic Ft | List Price |
|--|---------------|--|---|---|---------|----------|------------|
| ECA TELECOM PLATES<br><br>Compatible with:<br><br><br><br>Oasis Mini Power & Data<br>01-OASISMA, 01-OASISMB<br><br><br>Interact Power & Data<br>01-INTERACTG2A, 01-INTERACTG2B<br><br><br>Power Center<br>01-INTRFCIA, 01-INTRFCIB | 01-ABL        | Telecom Plate, Blank Plate   |   |   |         |          | \$ 39      |
|  | 01-ABL737373  | Telecom Plate, Three (3) RJ45 Cat 5e   |   |   |         |          | \$ 345     |
|  | 01-ABLAB      | Telecom Plate, One (1) RJ45 Cat 6, One (1) RJ11 Cat 3 Phone  |   |   |         |          | \$ 193     |
|  | 01-ABLAB102   | Telecom Plate, One (1) RJ45 Cat 6, One (1) RJ11 Cat 3, One (1) USB W/72" Patch Cord                              |   |   |         |          | \$ 300     |
|  | 01-ABLABB     | Telecom Plate, Two (2) RJ45 Cat 6, One (1) RJ11 Cat 3 Phone  |   |   |         |          | \$ 300     |
|  | 01-ABLB       | Telecom Plate, One (1) RJ45 Cat 6  |   |   |         |          | \$ 140     |
|  | 01-ABLBB      | Telecom Plate, Two (2) RJ45 Cat 6  |   |   |         |          | \$ 244     |
|  | 01-ABLBBB     | Telecom Plate, Three (3) RJ45 Cat 6  |   |   |         |          | \$ 345     |
|  | 01-ABLBBBB    | Telecom Plate, Four (4) RJ45 Cat 6   |   |   |         |          | \$ 447     |
|  | 01-ABLBBC51   | Telecom Plate, Two (2) RJ45 Cat 6, One (1) 15 Pin HD VGA w/72" Patch Cord  |   |   |         |          | \$ 418     |
|  | 01-ABLBC51L   | Telecom Plate, One (1) RJ45 Cat 6, One (1) Mini Stereo Inline, One (1) 15 Pin HD VGA w/72" Patch Cord            |   |   |         |          | \$ 384     |
|  | 01-ABLC3811   | Telecom Plate, One (1) RJ45 Cat 6 Data Inline, One (1) RJ11 Cat 3 Phone Inline                                   |   |   |         |          | \$ 184     |
|  | 01-ABLC45     | Telecom Plate, One (1) HDMI w/36" Patch Cord   |   |   |         |          | \$ 277     |
|  | 01-ABLC45C51L | Telecom Plate, One (1) Mini Stereo Inline, One (1) HDMI w/36" Patch Cord, One (1) 15 Pin HD VGA w/72" Patch Cord |   |   |         |          | \$ 523     |
|  | 01-ABL51L     | Telecom Plate, One (1) 15 Pin HD VGA & One (1) Mini Stereo Inline Jack   |   |   |         |          | \$ 280     |
|  | 01-ABLCRDM    | Telecom Plate, Three (3) Cord Bushings   |   |   |         |          | \$ 90      |



With a nod to the '50s and '60s, Iconic's clean lines, tapered legs, and unexpected details present a timeless, approachable quality while being suited to outfit a multitude of areas, including small meeting areas, huddle rooms and collaboration spaces.

### CONSTRUCTION

*Iconic features a Veneer chassis with your choice of a Veneer, HPL or 3D Laminate top. Units ship assembled unless otherwise noted.*

#### VENEER

- Exposed surfaces feature select-grade, plain-sliced hardwood Cherry, Maple, American Black Walnut, White Oak, and composite veneers; Veneers are carefully selected and matched to assure proper balance and consistency
- Veneer features UVAdvantage, an ultra-violet finish, on all exposed surfaces by utilizing roll-coat UV technology

#### LAMINATE

- TFL and HPL are made of woodgrain and solid color laminates fused to particleboard core; Each laminate offers lasting beauty, superior resistance to normal wear, and easy maintenance
- 3D laminate surfaces eliminate the need for edge banding, visible seams, and special edge treatments; elimination of seams helps mitigate the accumulation of potential contaminants and simplifies cleaning

#### TOPS

- Tops are 1 $\frac{3}{16}$ " thick
- Square (Y) Edge Profile is 3-ply balanced construction with 3mm wood edge-banded rims
- Square edge tops are shaped on all four sides
- Knife (KB) and Illusion (ILL) Edge Profile are 5-ply balanced construction with hardwood rims. Knife (KB) and Illusion (ILL) Edge Profile are profiled on three sides of Double Ped and Single Ped Desks with user side featuring Square Edge (Y)
- Grain direction runs left-to-right unless noted

#### CHASSIS

- Chassis are fastened by using high quality European fastening systems and heavy-duty, 16-gauge joining brackets to assure maximum strength
- All units ship with heavy-duty, adjustable glides to ensure proper leveling and compensate for uneven floors
- Horizontal grain direction unless otherwise noted

#### DRAWERS

- Box and file drawers are tested for 100lb capacity; Lateral file drawers are tested for 200lb capacity
- 5-sided drawer construction for easy removal of drawer fronts
- Fronts are 3-ply construction,  $\frac{3}{4}$ " thick with matched grain
- Sides, back, and front are  $\frac{1}{2}$ " thick woodgrain vinyl-wrapped miter fold construction; box and file drawers have  $\frac{1}{8}$ " thick hardboard bottoms, lateral file drawers feature  $\frac{1}{4}$ " thick bottoms
- Optional Dovetail construction with  $\frac{7}{16}$ " thick hardwood sides and backs and  $\frac{5}{32}$ " thick hardboard bottoms
- Box and file drawers feature full extension, progressive action slides with precision steel ball bearings with optional soft close
- Lateral files  $\frac{3}{4}$  extension, progressive action slides with precision steel ball bearings
- All suspensions have a limited lifetime warranty

#### FILING

- All file drawers are standard with filing systems designed to accommodate a variety of filing requirements
- Legal width file drawers provide legal filing front to back, and letter or legal filing side to side

#### STORAGE

- All hinged doors include soft close hinges
- Soft close hinges reduce stress placed on the cabinet when the door is closed and offers a quiet closure

#### LOCKING

- All units with drawers feature standard locking; optional locking available on models with doors where noted ([see locking options](#))
- Lock core available in black or silver, please specify color
- Removable lock cylinders allow for units to be re-keyed at a later date if required
- Units are shipped randomly keyed as standard
- Keyed alike units available upon request at no additional charge

#### CORD MANAGEMENT

- Grommets are available in the tops of credenzas
- An exit grommet is standard on the bottom of pedestals for wires to escape
- On units, where noted, a removable back panel for wire access/wire management, as well as an exit grommet, come standard
- Grommets are 2 $\frac{3}{8}$ " in diameter and available in black or silver
- See [all optional grommet locations](#)
- Wire channel available for additional under-surface cord management; [see accessories](#)

### INTERIOR DRAWER DIMENSIONS

#### Models

50-1872SWBL 50-1872SWBR

#### Drawers

|      | W                  | L                   | D                  |
|------|--------------------|---------------------|--------------------|
| Box  | 15 $\frac{3}{8}$ " | 16 $\frac{3}{16}$ " | 3 $\frac{1}{2}$ "  |
| File | 15 $\frac{3}{8}$ " | 16 $\frac{3}{16}$ " | 9 $\frac{5}{16}$ " |

#### Models

50-2472LOBL 50-2472LOBR 50-2472DBF 50-2472LDF  
50-2472OBFL 50-2472OBFR

#### Drawers

|          | W                   | L                   | D                 |
|----------|---------------------|---------------------|-------------------|
| Lat File | 32 $\frac{5}{32}$ " | 15 $\frac{1}{16}$ " | 9 $\frac{1}{4}$ " |

#### Models

50-2460LOBL 50-2466LOBL 50-2460OBFL 50-2466OBFL  
50-2460LOBR 50-2466LOBR 50-2460OBFR 50-2466OBFR  
50-2460DBF 50-2460LDF

#### Drawers

|          | W                   | L                   | D                 |
|----------|---------------------|---------------------|-------------------|
| Box      | 15 $\frac{3}{8}$ "  | 12 $\frac{1}{8}$ "  | 3 $\frac{1}{2}$ " |
| Lat File | 26 $\frac{5}{32}$ " | 15 $\frac{1}{16}$ " | 9 $\frac{1}{4}$ " |

**FILING CAPABILITIES**

**Drawers with Dimensions: 15<sup>5</sup>/<sub>8</sub>"W x 16<sup>1</sup>/<sub>8</sub>"L**

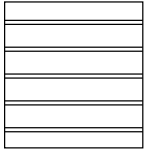

Letter Front to Back

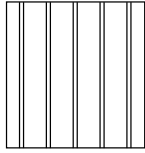

Legal Side to Side

**Drawers with Dimensions: 26<sup>3</sup>/<sub>2</sub>"W x 15<sup>1</sup>/<sub>8</sub>"L**

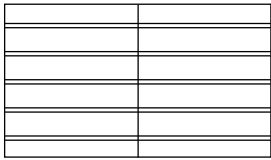

2 Rows Letter Front to Back

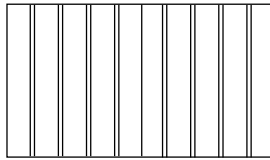

1 Row Legal Side to Side

**Drawers with Dimensions: 32<sup>3</sup>/<sub>2</sub>"W x 15<sup>1</sup>/<sub>8</sub>"L**

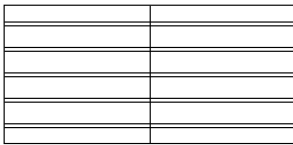

2 Rows Letter Front to Back

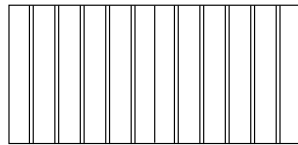

1 Row Legal Side to Side

**HOW TO ORDER EXAMPLES**

| Model No.    | Description                       | Example |
|--------------|-----------------------------------|---------|
| 50-3672TD    | Top Material                      | 3D      |
|              | Edge Profile                      | ILL     |
|              | Top Finish/Color                  | CR3     |
|              | Leg Finish                        | SBP     |
|              | Modesty Panel/Finish              | -       |
|              | Modesty Accent Material           | -       |
|              | Modesty Accent Color/Fabric       | -       |
| 01-DUOBEZELB | Grommet/Power/Data Location       | PDC-C   |
|              | Power/Data Unit                   | PDC-C   |
| 50-2472OBFL  | Top Material                      | P       |
|              | Top Finish/Color                  | SBP     |
|              | Chassis Finish                    | SBP     |
|              | Cabinet Accent Color              | CAFHG   |
|              | Finger Pull Accent Material/Color | FPPBSH  |
|              | Leg Finish                        | SBP     |
|              | Drawer Construction               | DOVE    |
|              | Drawer Track                      | SFTCL   |
|              | Lock Color                        | BLK     |
|              | Grommet/Power/Data                | GC, BLK |

**VENEER (W) OPTIONS**

Veneer features UV Advantage, an ultra-violet finish, on all exposed surfaces by utilizing roll-coat UV technology

|     |                    |     |                     |
|-----|--------------------|-----|---------------------|
| AW  | Artisan Walnut     | MW  | Mahogany Walnut     |
| AS  | Asian Night        | MO  | Medium Oak*         |
| CO  | Columbian Walnut   | ORW | Oak Riftwood*       |
| DC  | Dark Cherry        | SCH | Select Cherry       |
| DFW | Dark Forest Walnut | SKC | Shaker Cherry       |
| EW  | Espresso           | SBP | Smoky Brown Pear    |
| FO  | Fawn Oak*          | SM  | Sugar Maple         |
| GC  | Golden Cherry      | SW  | Sunglow Walnut      |
| HVM | Harvest Maple      | WTA | Weathered Ash*      |
| HW  | Harvest Walnut     | WC  | Williamsburg Cherry |
| LW  | Legacy Walnut      |     |                     |

\* Finish is Low Sheen

**HPL (P) OPTIONS**

|     |                  |     |                     |
|-----|------------------|-----|---------------------|
| AS  | Asian Night      | SCH | Select Cherry       |
| CO  | Columbian Walnut | SKC | Shaker Cherry       |
| EW  | Espresso         | SBP | Smoky Brown Pear    |
| GC  | Golden Cherry    | SM  | Sugar Maple         |
| HVM | Harvest Maple    | WTA | Weathered Ash       |
| MW  | Mahogany Walnut  | WC  | Williamsburg Cherry |
| ORW | Oak Riftwood     |     |                     |

**3D LAMINATE (3D) OPTIONS**

3D laminate surfaces eliminate the need for edge banding, visible seams, and special edge treatments. The elimination of seams helps to mitigate the accumulation of potential contaminants and simplifies cleaning. See cleaning instructions on our website under Resources.

Our Matte White and Matte Black options are not only durable, they leave no fingerprints. The matte, soft touch finish will add a sense of luxury, beauty, and style to any interior space.

Our Concrete option features a city-inspired, grey concrete surface with an embossed texture that is real to the touch and feel.

See individual select products for availability.

|     |             |     |             |
|-----|-------------|-----|-------------|
| CR3 | Concrete    | WH3 | Matte White |
| BL3 | Matte Black |     |             |

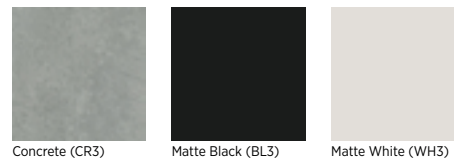

Concrete (CR3)    Matte Black (BL3)    Matte White (WH3)



### WOOD FINISH LEG OPTIONS

|     |                    |     |                     |
|-----|--------------------|-----|---------------------|
| AW  | Artisan Walnut     | MW  | Mahogany Walnut     |
| AS  | Asian Night        | MO  | Medium Oak          |
| CO  | Columbian Walnut   | ORW | Oak Riftwood        |
| DC  | Dark Cherry        | SCH | Select Cherry       |
| DFW | Dark Forest Walnut | SKC | Shaker Cherry       |
| EW  | Espresso           | SBP | Smoky Brown Pear    |
| FO  | Fawn Oak           | SM  | Sugar Maple         |
| GC  | Golden Cherry      | SW  | Sunglow Walnut      |
| HVM | Harvest Maple      | WTA | Weathered Ash       |
| HW  | Harvest Walnut     | WC  | Williamsburg Cherry |
| LW  | Legacy Walnut      |     |                     |

### SOLID COLORS

|    |       |    |                |
|----|-------|----|----------------|
| BL | Black | WH | Designer White |
|----|-------|----|----------------|

### EDGE PROFILE

Select units feature multiple profile options. See specific units for details. Double Ped and Single Ped Desks are profiled on three sides with user side featuring Square Edge (Y).

|    |          |   |        |
|----|----------|---|--------|
| I  | Illusion | Y | Square |
| KB | Knife    |   |        |

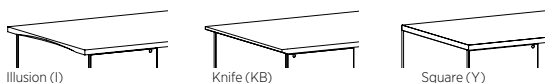

### PULL OPTIONS

|     |                      |     |                         |
|-----|----------------------|-----|-------------------------|
| STD | Finger Pull, Veneer* | BRD | Round Door Pull, Black  |
| FPF | Finger Pull, Fabric  | CRD | Round Door Pull, Chrome |
| FPP | Finger Pull, HPL     |     |                         |



Finger Pull



Round Door Pull

\*Veneer Finger Pull Finish will match chassis finish

### FINGER PULL HPL ACCENT (FPP) OPTIONS

|        |                |        |                 |
|--------|----------------|--------|-----------------|
| FPPBL  | Black          | FPPPPD | Pepperdust      |
| FPPBSH | Blush          | FPPSG  | Slate Grey      |
| FPPWH  | Designer White | FPPSV  | Summer Vacation |
| FPPENL | Enamel         | FPPSUS | Surfin USA      |
| FPPFHG | Fashion Grey   | FPPWHS | White Sand      |
| FPPFK  | First Kiss     |        |                 |



### MODESTY ACCENT HPL (P) OPTIONS

|        |                |        |                 |
|--------|----------------|--------|-----------------|
| MAPBL  | Black          | MAPPPD | Pepperdust      |
| MAPBSH | Blush          | MAPSG  | Slate Grey      |
| MAPWH  | Designer White | MAPSV  | Summer Vacation |
| MAPENL | Enamel         | MAPSUS | Surfin USA      |
| MAPFHG | Fashion Grey   | MAPWHS | White Sand      |
| MAPFK  | First Kiss     |        |                 |

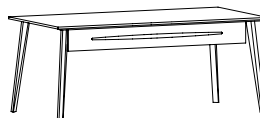

Modesty Panel is available in veneer only, while the Modesty Accent is available in veneer, HPL, or fabric. Veneer accent will match modesty finish.

### UPHOLSTERY OPTIONS

For units available with a Fabric Finger Pull or Modesty Accent, we offer a wide variety of graded-in or contract options. Due to the minimal, 1/2 yard requirement for Accent Features, all leather options for these units will be COL.

All graded-in fabrics, contract partners, and our COM/COL Form may be found online at: [www.indianafurniture.com/resources](http://www.indianafurniture.com/resources)

### INTERIOR CABINET ACCENT HPL (P) OPTIONS -

Select units feature an optional interior HPL accent color. See specific units for details.

|       |                |       |                 |
|-------|----------------|-------|-----------------|
| CABL  | Black          | CAPPD | Pepperdust      |
| CABSH | Blush          | CASG  | Slate Grey      |
| CAWH  | Designer White | CASV  | Summer Vacation |
| CAENL | Enamel         | CASUS | Surfin USA      |
| CAFHG | Fashion Grey   | CAWHS | White Sand      |
| CAFK  | First Kiss     |       |                 |

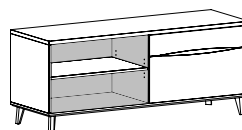

For example, shaded area denotes cabinet accent location

### DRAWER OPTIONS

Units with drawers come standard with woodgrain vinyl-wrapped drawers. Optional dove tail construction for all box, file, and lateral file drawers is available. Soft close is also available for all box and file drawers. Must specify when ordering.

Pricing is per Drawer, not per Model/Unit.

|       |   |    |    |
|-------|---|----|----|
| DOVE  | Dove Tail Wood Construction                       | \$ | 42 |
| SFTCL | Soft Close Drawer Track (Box & File Drawers Only) | \$ | 32 |

### LOCK CORE COLOR OPTIONS

|     |        |
|-----|--------|
| BLK | Black  |
| SLV | Silver |



**GROMMET OPTIONS & POWER UNIT LOCATIONS**

Grommets are available in tops of credenzas, and may be ordered without grommets at no additional charge. Please specify NO GROMMET on order.

Power/Data, Dock 950 and Dock 150 units must be specified separately with surface mount location. Dock 950 and Dock 150 units are available on Table Desks and Credenza Tops, and where otherwise noted.

Grommets are available in standard locations. Please specify using info below. Multiple locations may be selected. Only one unit per location.

**GROMMET LOCATIONS (Black = BLK and Silver = SLV)**

|    |                                      |    |    |
|----|--------------------------------------|----|----|
| GC | Grommet, Center - Specify BLK or SLV | \$ | 72 |
| GL | Grommet, Left - Specify BLK or SLV   | \$ | 72 |
| GR | Grommet, Right - Specify BLK or SLV  | \$ | 72 |

**DUO/TRIO BEZEL LOCATIONS (See Multiple Unit Details)**

|       |               |
|-------|---------------|
| PDC-C | Bezel, Center |
| PDC-L | Bezel, Left   |
| PDC-R | Bezel, Right  |

**DOCK 950 and DOCK 150 LOCATIONS (See Dock Units)**

|           |                                       |    |     |
|-----------|---------------------------------------|----|-----|
| DOCK950-L | D950 Wireless Charger, Left           | \$ | 249 |
| DOCK950-C | D950 Wireless Charger, Center         | \$ | 249 |
| DOCK950-R | D950 Wireless Charger, Right          | \$ | 249 |
| DOCK150-L | D150 Wireless and USB Charger, Left   | \$ | 380 |
| DOCK150-C | D150 Wireless and USB Charger, Center | \$ | 380 |
| DOCK150-R | D150 Wireless and USB Charger, Right  | \$ | 380 |

*Verify Grommet Option is available on the model(s) you are specifying using the following location information. Grommets, Power Units, Dock 950 and Dock 150 may be ordered in non-standard locations. Call Customer Service to assist with specification and/or please attach a drawing to the PO showing the location of the grommet. Note additional charges and lead times may apply.*

**Models**

|           |           |
|-----------|-----------|
| 50-3672TD | 50-3072TD |
| 50-3666TD | 50-3066TD |
| 50-3660TD | 50-3060TD |

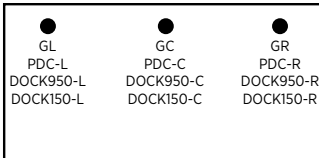

GL/GR/PDC-L/PDC-R/DOCK950-L/DOCK950-R/DOCK150-L/DOCK150-R: 6" from ends; 21" from user side

GC/PDC-C/DOCK950-C/DOCK150-C: 21" from user side

**Models**

|            |            |             |             |
|------------|------------|-------------|-------------|
| 50-2472DBF | 50-2472LDF | 50-2472LOBR | 50-2472OBFL |
| 50-2460DBF | 50-2460LDF | 50-2466LOBR | 50-2472OBFR |
| 50-2472LOB | 50-2472SDB | 50-2460LOBR | 50-2466OBFL |
| 50-2466LOB | 50-2466SDB | 50-2472LOBL | 50-2466OBFR |
| 50-2460LOB | 50-2460SDB | 50-2466LOBL | 50-2460OBFL |
|            |            | 50-2460LOBL | 50-2460OBFR |

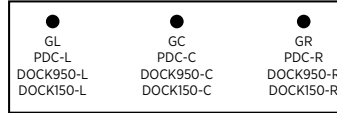

PDC-L/PDC-R: 11" from ends; 21 1/8" from user side  
PDC-C: 21 1/8" from user side

GL/GR/DOCK950-L/DOCK950-R/DOCK150-L/DOCK150-R: 6" from ends; 20" from user side

GC/DOCK950-C/DOCK150-C: 20" from user side

**LOCKING DOORS**

Locking doors are available on specific units, where noted.

You must specify WITH LOCKING when ordering, denote color, and add upcharge.

Color Options: Black (BLK) or Silver (SLV)

|        |                    |    |     |
|--------|--------------------|----|-----|
| LKT_HU | 72"W to 48"W Units | \$ | 108 |
| LKT_HU | 42"W to 30"W Units | \$ | 85  |
| LKT_HU | 18"W Units         | \$ | 65  |

**CERTIFICATIONS & COMPLIANCE**

- Intertek Sustainability Certified
- BIFMA level® Certified
- BIFMA Compliant Certified
- TSCA Title VI (formerly CARB) Compliance
- US Green Building's LEED Contribution

### Small Meeting Tables/Table Desks

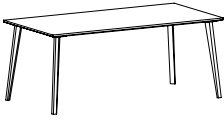

Tables/Table Desks  
[\(See Details\)](#)

### Storage

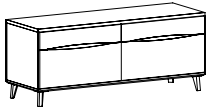

Double Box/Lateral  
File Credenza  
[\(See Details\)](#)

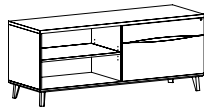

Open Bookcase and  
Box/Lateral Credenza  
[\(See Details\)](#)

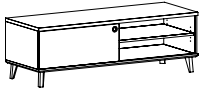

Open Bookcase w/Sliding  
Door Low Credenza  
[\(See Details\)](#)

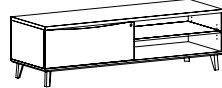

Open Bookcase and Lateral  
File Low Credenza  
[\(See Details\)](#)

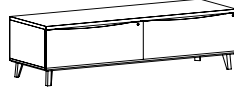

Double Lateral File  
Low Credenza  
[\(See Details\)](#)

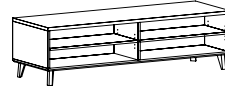

Double Open Bookcase  
Low Credenza  
[\(See Details\)](#)

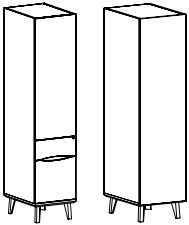

Single Wardrobes/Cabinets  
[\(See Details\)](#)

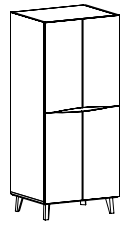

Double Wardrobe  
[\(See Details\)](#)

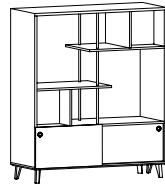

Freestanding Open  
Storage/Dividers  
[\(See Details\)](#)

### Wire Management & Power/Data Accessories [\(See Grommet and Power Units\)](#)

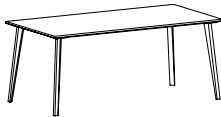

| Item  | Model No.  |                           | Width | Depth | Height | Ship Wt | Cubic Ft                | List Price              |  |
|---|--|---------------------------|-------|-------|--------|---------|-------------------------|-------------------------|--|
|  | <b>SQUARE (Y) EDGE PROFILE</b>                   |                           |       |       |        |         |                         |                         |  |
|   | 50-3672TD  | HPL/Veneer<br>3D Laminate | 72    | 36    | 30     | 137     | 9.8                     | P/W\$ 1868<br>3D\$ 4159 |  |
|   | 50-3666TD  | HPL/Veneer<br>3D Laminate | 66    | 36    | 30     | 129     | 9.0                     | P/W\$ 1823<br>3D\$ 3586 |  |
|   | 50-3660TD  | HPL/Veneer<br>3D Laminate | 60    | 36    | 30     | 121     | 8.2                     | P/W\$ 1778<br>3D\$ 3270 |  |
|   | 50-3072TD  | HPL/Veneer<br>3D Laminate | 72    | 30    | 30     | 103     | 10.2                    | P/W\$ 1777<br>3D\$ 3618 |  |
|   | 50-3066TD  | HPL/Veneer<br>3D Laminate | 66    | 30    | 30     | 95      | 9.6                     | P/W\$ 1723<br>3D\$ 3207 |  |
|   | 50-3060TD  | HPL/Veneer<br>3D Laminate | 60    | 30    | 30     | 87      | 8.9                     | P/W\$ 1677<br>3D\$ 3045 |  |
|   | <b>KNIFE (KB) OR ILLUSION (ILL) EDGE PROFILE</b> |                           |       |       |        |         |                         |                         |  |
|   | 50-3672TD<br>Knife                               | HPL/Veneer<br>3D Laminate | 72    | 36    | 30     | 137     | 9.8                     | P/W\$ 2206<br>3D\$ 4308 |  |
|   | 50-3666TD<br>Knife                               | HPL/Veneer<br>3D Laminate | 66    | 36    | 30     | 129     | 9.0                     | P/W\$ 2131<br>3D\$ 3651 |  |
| 50-3660TD<br>Knife  | HPL/Veneer<br>3D Laminate                        | 60                        | 36    | 30    | 121    | 8.2     | P/W\$ 2059<br>3D\$ 3322 |                         |  |
| 50-3072TD<br>Knife  | HPL/Veneer<br>3D Laminate                        | 72                        | 30    | 30    | 103    | 10.2    | P/W\$ 2058<br>3D\$ 3890 |                         |  |
| 50-3066TD<br>Knife  | HPL/Veneer<br>3D Laminate                        | 66                        | 30    | 30    | 95     | 9.6     | P/W\$ 1981<br>3D\$ 3259 |                         |  |
| 50-3060TD<br>Knife  | HPL/Veneer<br>3D Laminate                        | 60                        | 30    | 30    | 87     | 8.9     | P/W\$ 1910<br>3D\$ 3136 |                         |  |

Must Specify (in this order):

- Model #
- Top Material
- Edge Profile
- Top Finish/Color
- Leg Finish
- Modesty Panel/Finish
- Modesty Accent Material
- Modesty Accent Color
- Grommet/Power/Data Location

**Description**

- Standard With: Left to Right Grain Direction on Worksurface and Stiffener Bar
- Available with Contrasting Top, Modesty (optional), and Leg Color
- Top Available in Veneer (W), HPL (P), or 3D Laminate (3D)
- Three (3) Edge Profiles Available; Square (Y), Knife (KB), and Illusion (ILL)
- Shipped KD; Some Assembly Required
- Additional Options: Modesty Panel and Accent Feature (See Below); Power and Grommet Options ([See Grommet and Power Units](#))

**Optional Modesty: Specify & Add**



|        |                   |        |
|--------|-------------------|--------|
| 50-HMD | 7" Veneer Modesty | \$ 209 |
|--------|-------------------|--------|

**Optional Modesty Accent: Specify & Add**



|          |  |              |
|----------|--|--------------|
| 50-AVHMD | Modesty Accent, Veneer (Finish Will Match Modesty Selection)               | \$ NC        |
| 50-APHMD | Modesty Accent, HPL; Must Specify Color, <a href="#">See Color Options</a> | \$ 50        |
| 50-AFHMD | Modesty Accent, Fabric; Must Specify Fabric                                | \$ See Below |

| List Price/Grade       | Yards | 1/COM/<br>COL | 2  | 3   | 4   | 5   | 6   | 7   | 8   | 9   | 10  |
|------------------------|-------|---------------|----|-----|-----|-----|-----|-----|-----|-----|-----|
| Modesty Accent, Fabric | 0.5   | \$ 72         | 97 | 117 | 137 | 168 | 199 | 243 | 289 | 343 | 404 |

[See Iconic Overview For Ordering Options](#)

| Item  | Model No.  | Width | Depth | Height | Ship Wt | Cubic Ft | List Price |
|---|--|-------|-------|--------|---------|----------|------------|
| <b>CREDENZA WITH DOUBLE BOX/LATERAL FILE</b><br> | 50-2472DBF<br><i>Includes (2) 36" Wide Box/Lateral Files</i> | 72    | 24    | 30     | 316     | 35.4     | \$ 5885    |
|   | 50-2460DBF<br><i>Includes (2) 30" Wide Box/Lateral Files</i> | 60    | 24    | 30     | 276     | 30.0     | \$ 5484    |

Must Specify (in this order):

- Model #
- Top Material
- Top Finish/Color
- Chassis Finish
- Finger Pull Accent Material/Color
- Leg Finish
- Drawer Construction
- Drawer Track
- Lock Color
- Grommet/Power/Data Location

**Description**

- Standard With: Dual Locking Box/Lateral Pedestals, Legal or Letter Filing, Left to Right Grain Direction on Top, Horizontal Grain on Chassis, Square (Y) Edge Profile, and Two (2) Stiffener Bars for Added Support
- Available with Contrasting Top, Chassis, and Leg Color
- Top Available in Veneer (W) or HPL (P)
- Finger Pull Accents; Available in Veneer (FPV), HPL (FPP), or Fabric (FPF)
- Locking Pedestals; Available with Black (BLK) or Silver (SLV) Lock Cores
- Additional Options: Dove Tail Drawer Construction and Soft Close on Box Drawers ([See Drawer Options](#)); Grommet and Power/Data Options ([See Grommet and Power Units](#))

**Finger Pull Options: Must Specify & Add**

|     |  |    |           |
|-----|--|----|-----------|
| FPV | Finger Pull, Veneer Accent (Finish Will Match Chassis Selection)               | \$ | NC        |
| FPP | Finger Pull, HPL Accent; Must Specify Color, <a href="#">See Color Options</a> | \$ | 101       |
| FPF | Finger Pull, Fabric Accent; Must Specify Fabric                                | \$ | See Below |

| List Price/Grade    | Yards | 1/COM/COL | 2   | 3   | 4   | 5   | 6   | 7   | 8   | 9   | 10  |
|---------------------|-------|-----------|-----|-----|-----|-----|-----|-----|-----|-----|-----|
| Finger Pull, Fabric | 0.5   | \$ 144    | 169 | 189 | 209 | 240 | 271 | 315 | 361 | 415 | 476 |

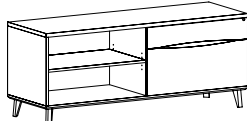
| <b>CREDENZA WITH OPEN BOOKCASE AND BOX/LATERAL</b><br> | Left Ped                         | Right Ped   | Width       | Depth | Height | Ship Wt | Cubic Ft | List Price |
|--|----------------------------------|-------------|-------------|-------|--------|---------|----------|------------|
|  |                                  | 50-2472OBFL | 50-2472OBFR | 72    | 24     | 30      | 296      | 35.4       |
|  | <i>36" Wide Box/Lateral File</i> |             |             |       |        |         |          |            |
|  | 50-2466OBFL                      | 50-2466OBFR | 66          | 24    | 30     | 276     | 32.7     | \$ 4885    |
|  | <i>30" Wide Box/Lateral File</i> |             |             |       |        |         |          |            |
|  | 50-2460OBFL                      | 50-2460OBFR | 60          | 24    | 30     | 256     | 30.0     | \$ 4607    |
|  | <i>30" Wide Box/Lateral File</i> |             |             |       |        |         |          |            |

Shown as Right

Must Specify (in this order):

- Model #
- Top Material
- Top Finish/Color
- Chassis Finish
- Cabinet Accent
- Finger Pull Accent Material/Color
- Leg Finish
- Drawer Construction
- Drawer Track
- Lock Color
- Grommet/Power/Data Location

**Description**

- Standard With: Box/Lateral File Locking Ped and Open Bookcase, One (1) Adjustable Shelf in Bookcase Ped, Legal or Letter Filing in Lateral File, Left to Right Grain Direction on Top, Horizontal Grain on Chassis, Square (Y) Edge Profile, and Two (2) Stiffener Bars for Added Support
- Open Bookcase Features Removable Back Panel for Wire Management; Exit Grommet on the Bottom of Both Sides for Wires to Escape
- Available with Contrasting Top, Chassis, and Leg Color
- Top Available in Veneer (W) or HPL (P)
- Finger Pull Accents Available in Veneer (FPV), HPL (FPP), or Fabric (FPF)
- Locking Pedestal; Available with Black (BLK) or Silver (SLV) Lock Cores
- Additional Options: HPL Cabinet Accent on Bookcase Interior (See Below); Dove Tail Drawer Construction and Soft Close on Box Drawers ([See Drawer Options](#)); Grommet and Power/Data Options ([See Grommet and Power Units](#))

**Finger Pull Options: Must Specify & Add**

|     |  |    |           |
|-----|--|----|-----------|
| FPV | Finger Pull, Veneer Accent (Finish Will Match Chassis Selection)               | \$ | NC        |
| FPP | Finger Pull, HPL Accent; Must Specify Color, <a href="#">See Color Options</a> | \$ | 50        |
| FPF | Finger Pull, Fabric Accent; Must Specify Fabric                                | \$ | See Below |

| List Price/Grade    | Yards | 1/COM/COL | 2  | 3   | 4   | 5   | 6   | 7   | 8   | 9   | 10  |
|---------------------|-------|-----------|----|-----|-----|-----|-----|-----|-----|-----|-----|
| Finger Pull, Fabric | 0.5   | \$ 72     | 97 | 117 | 137 | 168 | 199 | 243 | 289 | 343 | 404 |

**Cabinet Accent Option: Specify & Add**

|   |    |     |
|---|----|-----|
| Cabinet Accent on Bookcase Interior ( <a href="#">See Color Options</a> ) | \$ | 152 |
|---|----|-----|

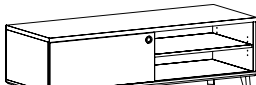
| Item   | Model No.  | Width | Depth | Height | Ship Wt | Cubic Ft | List Price |
|--|------------|-------|-------|--------|---------|----------|------------|
| <b>LOW CREDENZA WITH OPEN BOOKCASE AND SLIDING DOOR</b><br> | 50-2472SDB | 72    | 24    | 21 7/8 | 250     | 25.5     | \$ 4237    |
|  | 50-2466SDB | 66    | 24    | 21 7/8 | 230     | 23.5     | \$ 3990    |
|  | 50-2460SDB | 60    | 24    | 21 7/8 | 210     | 21.5     | \$ 3829    |

**Description**

- Standard With: Open Bookcase with One (1) Non-Locking Sliding Door, One (1) Adjustable Shelf on Each Side, Left to Right Grain Direction on Top, Horizontal Grain on Chassis, and Square (Y) Edge Profile
- Open Bookcase Features Removable Back Panel for Wire Management; Exit Grommet on the Bottom of Both Sides for Wires to Escape
- Available with Contrasting Top, Chassis, and Leg Color
- Top Available in Veneer (W) or HPL (P)
- Sliding Door; Available with Round Door Pull in Black (BRD) or Chrome (CRD)
- Additional Options: HPL Cabinet Accent on Bookcase Interior (See Below); Grommet and Power/Data Options ([See Grommet and Power Units](#))

Must Specify (in this order):

- Model #
- Top Material
- Top Finish/Color
- Chassis Finish
- Cabinet Accent
- Round Pull Color
- Leg Finish
- Grommet/Power/Data Location

**Cabinet Accent Option: Specify & Add**

|   |        |
|---|--------|
| Cabinet Accent on Bookcase Interior ( <a href="#">See Color Options</a> ) | \$ 254 |
|---|--------|

**LOW CREDENZA WITH OPEN BOOKCASE AND LATERAL FILE**

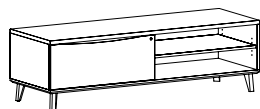

Shown as Left

| Left Ped                     | Right Ped   | Width | Depth | Height | Ship Wt | Cubic Ft | List Price |
|------------------------------|-------------|-------|-------|--------|---------|----------|------------|
| 50-2472LOBL                  | 50-2472LOBR | 72    | 24    | 21 7/8 | 255     | 25.5     | \$ 4599    |
| <i>36" Wide Lateral File</i> |             |       |       |        |         |          |            |
| 50-2466LOBL                  | 50-2466LOBR | 66    | 24    | 21 7/8 | 235     | 23.5     | \$ 4419    |
| <i>30" Wide Lateral File</i> |             |       |       |        |         |          |            |
| 50-2460LOBL                  | 50-2460LOBR | 60    | 24    | 21 7/8 | 215     | 21.5     | \$ 4251    |
| <i>30" Wide Lateral File</i> |             |       |       |        |         |          |            |

**Description**

- Standard With: Legal Width Locking Lateral File Ped with Open Bookcase, One (1) Adjustable Shelf in Bookcase, Left to Right Grain Direction on Top, Horizontal Grain on Chassis, and Square (Y) Edge Profile
- Open Bookcase Features Removable Back Panel for Wire Management; Exit Grommet on the Bottom of Both Sides for Wires to Escape
- Available with Contrasting Top, Chassis, and Leg Color
- Top Available in Veneer (W) or HPL (P)
- Finger Pull Accents Available in Veneer (FPV), HPL (FPP), or Fabric (FPF)
- Locking Pedestal; Available with Black (BLK) or Silver (SLV) Lock Cores
- Additional Options: HPL Cabinet Accent on Bookcase Interior (See Below); Dove Tail Drawer Construction ([See Drawer Options](#)); Grommet and Power/Data Options ([See Grommet and Power Units](#))

Must Specify (in this order):

- Model #
- Top Material
- Top Finish/Color
- Chassis Finish
- Cabinet Accent
- Finger Pull Accent Material/Color
- Leg Finish
- Drawer Construction
- Lock Color
- Grommet/Power/Data Location

**Finger Pull Options: Must Specify & Add**

|     |  |              |
|-----|--|--------------|
| FPV | Finger Pull, Veneer Accent (Finish Will Match Chassis Selection)               | \$ NC        |
| FPP | Finger Pull, HPL Accent; Must Specify Color, <a href="#">See Color Options</a> | \$ 50        |
| FPF | Finger Pull, Fabric Accent; Must Specify Fabric                                | \$ See Below |

| List Price/Grade    | Yards | 1/COM/COL | 2  | 3   | 4   | 5   | 6   | 7   | 8   | 9   | 10  |
|---------------------|-------|-----------|----|-----|-----|-----|-----|-----|-----|-----|-----|
| Finger Pull, Fabric | 0.5   | \$ 72     | 97 | 117 | 137 | 168 | 199 | 243 | 289 | 343 | 404 |

**Cabinet Accent Option: Specify & Add**

|   |        |
|---|--------|
| Cabinet Accent on Bookcase Interior ( <a href="#">See Color Options</a> ) | \$ 137 |
|---|--------|

[See Iconic Overview For Ordering Options](#)

| Item  | Model No.   | Width | Depth | Height           | Ship Wt | Cubic Ft | List Price |
|---|---|-------|-------|------------------|---------|----------|------------|
| <b>LOW CREDENZA WITH DOUBLE LATERAL FILE</b><br><br> | 50-2472LDF<br><i>Includes (2) 36" Wide Lateral File</i> | 72    | 24    | 21 $\frac{7}{8}$ | 265     | 25.5     | \$ 5283    |
|   | 50-2460LDF<br><i>Includes (2) 30" Wide Lateral File</i> | 60    | 24    | 21 $\frac{7}{8}$ | 225     | 21.5     | \$ 4797    |

Must Specify (in this order):

- Model #
- Top Material
- Top Finish/Color
- Chassis Finish
- Finger Pull Accent Material/Color
- Leg Finish
- Drawer Construction
- Lock Color
- Grommet/Power/Data Location

**Description**

- Standard With: Legal Width Dual Locking Lateral File Peds, Left to Right Grain Direction on Top, Horizontal Grain Direction on Chassis, Square (Y) Edge Profile, and Two (2) Stiffener Bars for Added Support
- Available with Contrasting Top, Chassis, and Leg Color
- Top Available in Veneer (W) or HPL (P)
- Finger Pull Accents Available in Veneer (FPV), HPL (FPP), or Fabric (FPF)
- Locking Pedestals; Available with Black (BLK) or Silver (SLV) Lock Cores
- Additional Options: Dove Tail Drawer Construction ([See Drawer Options](#)); Grommet and Power/Data Options ([See Grommet and Power Units](#))

**Finger Pull Options: Must Specify & Add**

|     |  |    |           |
|-----|--|----|-----------|
| FPV | Finger Pull, Veneer Accent (Finish Will Match Chassis Selection)               | \$ | NC        |
| FPP | Finger Pull, HPL Accent; Must Specify Color, <a href="#">See Color Options</a> | \$ | 101       |
| FPF | Finger Pull, Fabric Accent; Must Specify Fabric                                | \$ | See Below |

| List Price/Grade    | Yards | 1/COM/COL | 2   | 3   | 4   | 5   | 6   | 7   | 8   | 9   | 10  |
|---------------------|-------|-----------|-----|-----|-----|-----|-----|-----|-----|-----|-----|
| Finger Pull, Fabric | 0.5   | \$ 144    | 169 | 189 | 209 | 240 | 271 | 315 | 361 | 415 | 476 |

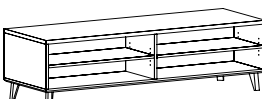
|  |            |    |    |                  |     |      |         |
|--|------------|----|----|------------------|-----|------|---------|
| <b>LOW CREDENZA WITH DOUBLE OPEN BOOKCASE</b><br><br> | 50-2472LOB | 72 | 24 | 21 $\frac{7}{8}$ | 245 | 25.5 | \$ 4098 |
|  | 50-2466LOB | 66 | 24 | 21 $\frac{7}{8}$ | 225 | 23.5 | \$ 3894 |
|  | 50-2460LOB | 60 | 24 | 21 $\frac{7}{8}$ | 205 | 21.5 | \$ 3753 |

Must Specify (in this order):

- Model #
- Top Material
- Top Finish/Color
- Chassis Finish
- Cabinet Accent
- Leg Finish
- Grommet/Power/Data Location

**Description**

- Standard With: One (1) Adjustable Shelf on Each Side, Left to Right Grain Direction on Top, Horizontal Grain Direction on Chassis, and Square (Y) Edge Profile
- Both Sides Feature Removable Back Panel for Wire Management and Exit Grommet on the Bottom for Wires to Escape
- Available with Contrasting Top, Chassis, and Leg Color
- Tops Available in Veneer (W) or HPL (P)
- Additional Options: HPL Cabinet Accent on Bookcase Interior (See Below); Grommet and Power/Data Options ([See Grommet and Power Units](#))

**Cabinet Accent Option: Specify & Add**

|   |    |     |
|---|----|-----|
| Cabinet Accent on Bookcase Interior ( <a href="#">See Color Options</a> ) | \$ | 245 |
|---|----|-----|

| Item                          | Model No.        |                   | Width | Depth | Height           | Ship Wt | Cubic Ft | List Price |
|-------------------------------|------------------|-------------------|-------|-------|------------------|---------|----------|------------|
| STORAGE CABINET WITH BOX/FILE | Door Hinged Left | Door Hinged Right |       |       |                  |         |          |            |
|                               | 50-1872SWBL      | 50-1872SWBR       | 18    | 24    | 70 $\frac{1}{2}$ | 230     | 22.0     | \$ 4479    |

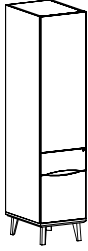

Shown as Left

Must Specify (in this order):

- Model #
- Chassis Finish
- Finger Pull Accent Material/Color
- Leg Finish
- Drawer Construction
- Drawer Track
- Locking Door
- Lock Color

**Description**

- Standard With: Veneer Finish, Locking Box/File Drawers (Legal or Letter Filling), Soft-Close Touch Latch Door, Two (2) Adjustable Shelves Inside, and Horizontal Grain Direction
- Available with Contrasting Chassis and Leg Color
- Finger Pull Accents Available in Veneer (FPV), HPL (FPP), or Fabric (FPF)
- Locking Box/File Drawers; Available with Black (BLK) or Silver (SLV) Lock Cores
- Additional Options: Dove Tail Drawer Construction and Soft Close Drawers ([See Drawer Options](#)); Locking Door ([See Locking Options](#))

**Finger Pull Options: Must Specify & Add**

|     |  |    |           |
|-----|--|----|-----------|
| FPV | Finger Pull, Veneer Accent (Finish Will Match Chassis Selection)               | \$ | NC        |
| FPP | Finger Pull, HPL Accent; Must Specify Color, <a href="#">See Color Options</a> | \$ | 101       |
| FPF | Finger Pull, Fabric Accent; Must Specify Fabric                                | \$ | See Below |

| List Price/Grade    | Yards | 1/COM/COL | 2   | 3   | 4   | 5   | 6   | 7   | 8   | 9   | 10  |
|---------------------|-------|-----------|-----|-----|-----|-----|-----|-----|-----|-----|-----|
| Finger Pull, Fabric | 0.5   | \$ 144    | 169 | 189 | 209 | 240 | 271 | 315 | 361 | 415 | 476 |

| Item             | Model No.        |                   | Width | Depth | Height           | Ship Wt | Cubic Ft | List Price |
|------------------|------------------|-------------------|-------|-------|------------------|---------|----------|------------|
| STORAGE WARDROBE | Door Hinged Left | Door Hinged Right |       |       |                  |         |          |            |
|                  | 50-2472WL        | 50-2472WR         | 18    | 24    | 70 $\frac{1}{2}$ | 213     | 22.0     | \$ 4016    |
|                  | 50-2451WL        | 50-2451WR         | 18    | 24    | 51 $\frac{1}{2}$ | 154     | 15.9     | \$ 3482    |

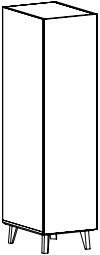

Shown as Left

Must Specify (in this order):

- Model #
- Chassis Finish
- Leg Finish
- Locking Door/Color

**Description**

- Standard With: Veneer Finish, Soft-Close Touch Latch Door, One (1) Fixed Shelf, Coat Rod Under Fixed Shelf, Three (3) Adjustable Shelves, and Horizontal Grain Direction
- Available with Contrasting Chassis and Leg Color
- Additional Option: Locking Door ([See Locking Options](#))

[See Iconic Overview For Ordering Options](#)



| Item            | Model No. | Width | Depth | Height           | Ship Wt | Cubic Ft | List Price |
|-----------------|-----------|-------|-------|------------------|---------|----------|------------|
| DOUBLE WARDROBE | 50-3672WC | 36    | 24    | 70 $\frac{7}{8}$ | 321     | 41.7     | \$ 6295    |
|                 | 50-3072WC | 30    | 24    | 70 $\frac{7}{8}$ | 283     | 35.1     | \$ 6133    |

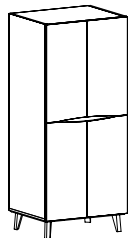

**Description**

- Standard With: Veneer Finish, Four (4) Soft-Close Touch Latch Doors, Both Sides Feature One (1) Fixed Shelf at Center and Two (2) Adjustable Shelves Inside, and Horizontal Grain Direction
- Available with Contrasting Chassis and Leg Color
- Finger Pull Accents Available in Veneer (FPV), HPL (FPP), or Fabric (FPF)
- Additional Option: Locking Doors ([See Locking Options](#))

Must Specify (in this order):

- Model #
- Chassis Finish
- Finger Pull Accent Material/Color
- Leg Finish
- Locking Door/Color

**Finger Pull Options: Must Specify & Add**

|     |  |    |           |
|-----|--|----|-----------|
| FPV | Finger Pull, Veneer Accent (Finish Will Match Chassis Selection)               | \$ | NC        |
| FPP | Finger Pull, HPL Accent; Must Specify Color, <a href="#">See Color Options</a> | \$ | 101       |
| FPF | Finger Pull, Fabric Accent; Must Specify Fabric                                | \$ | See Below |

| List Price/Grade    | Yards | 1/COM/COL | 2   | 3   | 4   | 5   | 6   | 7   | 8   | 9   | 10  |
|---------------------|-------|-----------|-----|-----|-----|-----|-----|-----|-----|-----|-----|
| Finger Pull, Fabric | 0.5   | \$ 144    | 169 | 189 | 209 | 240 | 271 | 315 | 361 | 415 | 476 |

**OPEN STORAGE/DIVIDER WITH SLIDING DOORS**

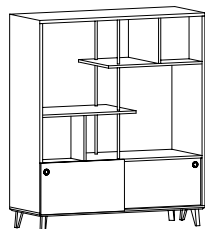

|  |    |    |                  |     |      |         |
|--|----|----|------------------|-----|------|---------|
| 50-2460OSD72   | 60 | 24 | 70 $\frac{7}{8}$ | 328 | 68.1 | \$ 6776 |
| <i>15" Clearance Between Shelves</i>                         |    |    |                  |     |      |         |
| 50-2460OSD51   | 60 | 24 | 51 $\frac{1}{2}$ | 308 | 49.4 | \$ 6428 |
| <i>8 <math>\frac{5}{8}</math>" Clearance Between Shelves</i> |    |    |                  |     |      |         |

**Description**



- Standard With: Veneer Finish, Dual Access Open Bookcase with Fixed Shelves, Two (2) Adjustable Shelves Behind Two (2) Non-Locking Sliding Doors, Metal Rods, and Horizontal Grain Direction
- Dual Access Cubbies are 10" Deep on each side
- Available with Contrasting Chassis and Leg Color
- Round Door Pull Available in Black (BRD) or Chrome (CRD)
- Accent Metal Rod Color Will Match Round Door Pull
- Additional Option: HPL Cabinet Accent on Interior (See Below)

Must Specify (in this order):

- Model #
- Chassis Finish
- HPL72 Cabinet Accent
- HPL51 Round Pull/Metal Accent Color
- Leg Finish

**Cabinet Accent Option: Specify & Add**

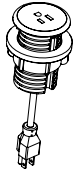
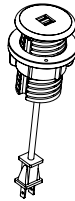
|   |    |     |
|---|----|-----|
| 72"H Unit, HPL Cabinet Accent on Interior ( <a href="#">See Color Options</a> ) | \$ | 272 |
| 51"H Unit, HPL Cabinet Accent on Interior ( <a href="#">See Color Options</a> ) | \$ | 256 |

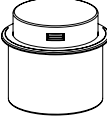
| Item  | Model No.   |        | Width              | Depth              | Height          | Ship Wt | Cubic Ft | List Price |
|---|---|--------|--------------------|--------------------|-----------------|---------|----------|------------|
|    | 01-GRMTB  | Black  | 2 $\frac{3}{8}$ "  | 2 $\frac{3}{8}$ "  | -               | 1       | 0.1      | \$ 33      |
|   | 01-GRMTSL   | Silver |                    |                    |                 |         |          | \$ 33      |
|   | <i>Open Market Only</i>   |        |                    |                    |                 |         |          |            |
|   | <b>Description</b>  |        |                    |                    |                 |         |          |            |
|   | <ul style="list-style-type: none"> <li>• 2<math>\frac{3}{8}</math>" (60mm) Round Grommet Cover</li> <li>• Field Installed</li> </ul>  |        |                    |                    |                 |         |          |            |
|    | 01-SAND60PW   | White  | 3                  | 3                  | 4               | 1       | 0.2      | \$ 92      |
|   | 01-SAND60PB   | Black  |                    |                    |                 |         |          | \$ 92      |
|   | 01-SAND60PS   | Silver |                    |                    |                 |         |          | \$ 92      |
|   | <b>Description</b>  |        |                    |                    |                 |         |          |            |
|   | <ul style="list-style-type: none"> <li>• Mounts in 2<math>\frac{3}{8}</math>" (60mm) Round Grommet</li> <li>• Single Power Outlet with 6' Cord</li> </ul>   |        |                    |                    |                 |         |          |            |
|   | 01-SAND60UW   | White  | 3                  | 3                  | 4               | 1       | 0.2      | \$ 260     |
|   | 01-SAND60UB   | Black  |                    |                    |                 |         |          | \$ 260     |
|   | 01-SAND60US   | Silver |                    |                    |                 |         |          | \$ 260     |
|   | <b>Description</b>  |        |                    |                    |                 |         |          |            |
|   | <ul style="list-style-type: none"> <li>• Mounts in 2<math>\frac{3}{8}</math>" (60mm) Round Grommet</li> <li>• Dual USB Outlets with 6' Cord</li> </ul>  |        |                    |                    |                 |         |          |            |
|  | 01-DOCK950W   | White  | 3 $\frac{1}{10}$ " | 3 $\frac{3}{10}$ " | -               | 1       | 0.2      | \$ 249     |
|   | 01-DOCK950B   | Black  |                    |                    |                 |         |          | \$ 249     |
|   | <b>Description</b>  |        |                    |                    |                 |         |          |            |
|   | <ul style="list-style-type: none"> <li>• For Use with Wireless Charging Enabled Devices</li> <li>• 5 Watts Maximum Output with a Direct Current of 5V 2A and 10 Watts Maximum with Quick Charge 2.0</li> <li>• Mounts in 76mm Round Cut-Out</li> <li>• LED will Confirm Pairing with Device and Begin Wireless Charging</li> </ul>  |        |                    |                    |                 |         |          |            |
|  | 01-DOCK150W   | White  | 3                  | 3                  | $\frac{3}{4}$ " | 1       | 0.2      | \$ 380     |
|   | 01-DOCK150B   | Black  |                    |                    |                 |         |          | \$ 380     |
|   | <b>Description</b>  |        |                    |                    |                 |         |          |            |
|   | <ul style="list-style-type: none"> <li>• For Use with Wireless Charging Enabled Devices and USB Charging Devices</li> <li>• 5 Watt Maximum Output with a Direct Current Input of 5V 6A (Wireless Fast Charge)</li> <li>• Mounts in 76mm Round Cut-Out</li> <li>• Pop-Up is <math>\frac{3}{4}</math>"H and Includes Three (3) USB Ports; One (1) 12 Watt Maximum with 2.4A (USB Fast Charge) and Two (2) 5 Watt with 1A (USB Standard Charge)</li> <li>• LED Light will Confirm Pairing with Device and Begin Wireless Charging</li> <li>• UL and cUL Certified</li> </ul> |        |                    |                    |                 |         |          |            |

Open Market Only

Open Market Only

[See Iconic Overview For Ordering Options](#)

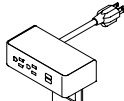
| Item  | Model No.     |        | Width | Depth | Height | Ship Wt | Cubic Ft | List Price |
|---|---------------|--------|-------|-------|--------|---------|----------|------------|
|  | 01-DUOCLAMPW  | White  | 6½    | 3     | 7      | 1       | 0.2      | \$ 537     |
|   | 01-DUOCLAMPB  | Black  |       |       |        |         |          | \$ 537     |
|   | 01-DUOCLAMP S | Silver |       |       |        |         |          | \$ 537     |

### Description

- Clamps to Worksurface and Includes: Two (2) Power, Two (2) USB, 10' Cord, and All Mounting Hardware
- Silver Metal Trim on All Color Options
- Independent USB Circuit Controllers Deliver up to 2.1 Amps to Each Post
- FCC Part 15A, UL Approved for Horizontal and Vertical Applications

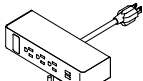
|   |                |        |   |   |   |   |     |        |
|---|----------------|--------|---|---|---|---|-----|--------|
|  | 01-TRIOCLAMPW  | White  | 9 | 3 | 7 | 1 | 0.2 | \$ 629 |
|   | 01-TRIOCLAMPB  | Black  |   |   |   |   |     | \$ 629 |
|   | 01-TRIOCLAMP S | Silver |   |   |   |   |     | \$ 629 |

### Description

- Clamps to Worksurface and Includes: Three (3) Power, Two (2) USB, One (1) Open Data, 10' Cord, and All Mounting Hardware
- HDMI, VGA, or RJ45 Accessory for Open Data Port Specified Separately, [See Accessories](#)
- Silver Metal Trim on All Color Options
- Independent USB Circuit Controllers Deliver up to 2.1 Amps to Each Post
- FCC Part 15A, UL Approved for Horizontal and Vertical Applications

|   |               |        |    |    |    |   |     |        |
|---|---------------|--------|----|----|----|---|-----|--------|
|  | 01-DUOBEZELW  | White  | 6½ | 2½ | 3¼ | 1 | 0.2 | \$ 633 |
|   | 01-DUOBEZELB  | Black  |    |    |    |   |     | \$ 633 |
|   | 01-DUOBEZEL S | Silver |    |    |    |   |     | \$ 633 |

### Description

- Sits on Worksurface and Includes: Two (2) Power, Two (2) USB, 10' Cord, and All Mounting Hardware
- Independent USB Circuit Controllers Deliver up to 2.1 Amps to Each Post
- FCC Part 15A, UL Approved for Horizontal and Vertical Applications

|   |                |        |   |    |   |   |     |        |
|---|----------------|--------|---|----|---|---|-----|--------|
|  | 01-TRIOBEZELW  | White  | 9 | 2½ | 3 | 1 | 0.2 | \$ 680 |
|   | 01-TRIOBEZELB  | Black  |   |    |   |   |     | \$ 680 |
|   | 01-TRIOBEZEL S | Silver |   |    |   |   |     | \$ 680 |

### Description

- Sits on Worksurface and Includes: Three (3) Power, Two (2) USB, One (1) Open Data, 10' Cord, and All Mounting Hardware
- HDMI, VGA, or RJ45 Accessory for Open Data Port Specified Separately, [See Accessories](#)
- Independent USB Circuit Controllers Deliver up to 2.1 Amps to Each Post
- FCC Part 15A, UL Approved for Horizontal and Vertical Applications

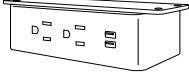
| Item  | Model No.   |        | Width | Depth | Height | Ship Wt | Cubic Ft | List Price |
|---|-------------|--------|-------|-------|--------|---------|----------|------------|
|  | 01-DUUNDERW | White  | 6½    | 2½    | 3      | 1       | 0.2      | \$ 513     |
|   | 01-DUUNDERB | Black  |       |       |        |         |          | \$ 513     |
|   | 01-DUUNDERS | Silver |       |       |        |         |          | \$ 513     |

**Description**

- Sits Under Worksurface and Includes: Two (2) Power, Two (2) USB, 10' Cord, and All Mounting Hardware
- Independent USB Circuit Controllers Deliver up to 2.1 Amps to Each Post
- FCC Part 15A, UL Approved for Horizontal and Vertical Applications

|   |               |        |   |    |   |   |     |        |
|---|---------------|--------|---|----|---|---|-----|--------|
|  | 01-TRIOUNDERW | White  | 9 | 2½ | 3 | 1 | 0.2 | \$ 615 |
|   | 01-TRIOUNDERB | Black  |   |    |   |   |     | \$ 615 |
|   | 01-TRIOUNDERS | Silver |   |    |   |   |     | \$ 615 |

**Description**

- Sits Under Worksurfaces and Includes: Three (3) Power, Two (2) USB, One (1) Open Data, 10' Cord, and All Mounting Hardware
- HDMI, VGA, or RJ45 Accessory for Open Data Port Specified Separately, [See Accessories](#)
- Independent USB Circuit Controllers Deliver up to 2.1 Amps to Each Post
- FCC Part 15A, UL Approved for Horizontal and Vertical Applications

**DUO BEZEL HARD WIRE****Circuit 1**

|                 |        |    |    |   |   |     |        |
|-----------------|--------|----|----|---|---|-----|--------|
| 01-HWDUOBEZELW1 | White  | 6½ | 2½ | 3 | 1 | 0.2 | \$ 684 |
| 01-HWDUOBEZELB1 | Black  |    |    |   |   |     |        |
| 01-HWDUOBEZELS1 | Silver |    |    |   |   |     |        |

**Circuit 2**

|                 |        |    |    |   |   |     |        |
|-----------------|--------|----|----|---|---|-----|--------|
| 01-HWDUOBEZELW2 | White  | 6½ | 2½ | 3 | 1 | 0.2 | \$ 684 |
| 01-HWDUOBEZELB2 | Black  |    |    |   |   |     |        |
| 01-HWDUOBEZELS2 | Silver |    |    |   |   |     |        |

**Circuit 3**

|                 |        |    |    |   |   |     |        |
|-----------------|--------|----|----|---|---|-----|--------|
| 01-HWDUOBEZELW3 | White  | 6½ | 2½ | 3 | 1 | 0.2 | \$ 684 |
| 01-HWDUOBEZELB3 | Black  |    |    |   |   |     |        |
| 01-HWDUOBEZELS3 | Silver |    |    |   |   |     |        |

**Circuit 4**

|                 |        |    |    |   |   |     |        |
|-----------------|--------|----|----|---|---|-----|--------|
| 01-HWDUOBEZELW4 | White  | 6½ | 2½ | 3 | 1 | 0.2 | \$ 684 |
| 01-HWDUOBEZELB4 | Black  |    |    |   |   |     |        |
| 01-HWDUOBEZELS4 | Silver |    |    |   |   |     |        |

**Description**

- Sits on worksurface and includes: Two (2) Power, Two (2) USB Power, and all mounting hardware
- Independent USB Circuit Controllers Deliver up to 2.1 Amps to Each Post
- FCC Part 15A and UL Approved for Horizontal and Vertical Applications
- Maximum 10 Duo Units per Circuit
- Eight (8) Wire/Four (4) Circuit Hard Wire Power Unit

[See Iconic Overview For Ordering Options](#)

| Item  | Model No.        |        | Width | Depth | Height | Ship Wt | Cubic Ft | List Price |  |
|---|------------------|--------|-------|-------|--------|---------|----------|------------|--|
|  | <b>Circuit 1</b> |        |       |       |        |         |          |            |  |
|   | 01-HWTRIOBEZELW1 | White  | 9     | 2½    | 3      | 1       | 0.2      | \$ 703     |  |
|   | 01-HWTRIOBEZELB1 | Black  |       |       |        |         |          |            |  |
|   | 01-HWTRIOBEZELS1 | Silver |       |       |        |         |          |            |  |
|   | <b>Circuit 2</b> |        |       |       |        |         |          |            |  |
|   | 01-HWTRIOBEZELW2 | White  | 9     | 2½    | 3      | 1       | 0.2      | \$ 703     |  |
|   | 01-HWTRIOBEZELB2 | Black  |       |       |        |         |          |            |  |
|   | 01-HWTRIOBEZELS2 | Silver |       |       |        |         |          |            |  |
|   | <b>Circuit 3</b> |        |       |       |        |         |          |            |  |
|   | 01-HWTRIOBEZELW3 | White  | 9     | 2½    | 3      | 1       | 0.2      | \$ 703     |  |
|   | 01-HWTRIOBEZELB3 | Black  |       |       |        |         |          |            |  |
|   | 01-HWTRIOBEZELS3 | Silver |       |       |        |         |          |            |  |
| <b>Circuit 4</b>  |                  |        |       |       |        |         |          |            |  |
| 01-HWTRIOBEZELW4  | White            | 9      | 2½    | 3     | 1      | 0.2     | \$ 703   |            |  |
| 01-HWTRIOBEZELB4  | Black            |        |       |       |        |         |          |            |  |
| 01-HWTRIOBEZELS4  | Silver           |        |       |       |        |         |          |            |  |

**Description**

- Sits on worksurface and includes: Three (3) Power, Two (2) USB Power, and all mounting hardware
- Independent USB Circuit Controllers Deliver up to 2.1 Amps to Each Post
- FCC Part 15A and UL Approved for Horizontal and Vertical Applications
- HDMI, VGA, or RJ45 Accessory for Open Data Port Specified Separately, [See Accessories](#)
- Maximum 6 Trio Units per Circuit
- Eight (8) Wire/Four (4) Circuit Hard Wire Power Unit

|                       |                |  |   |   |   |   |     |       |
|-----------------------|----------------|--|---|---|---|---|-----|-------|
| QUAD BLOCK HARD WIRED | 01-HWQUADBLOCK |  | - | - | - | 1 | 0.2 | \$ 58 |
|-----------------------|----------------|--|---|---|---|---|-----|-------|

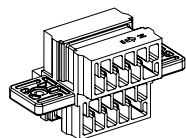

**Description**

- Eight (8) Wire/Four (4) Circuit Hard Wire Connector
- UL183 Compliant
- For Connecting Jumpers and Power Units
- Quantity of Four (4) Female Inputs

|                        |                 |  |    |   |   |   |     |        |
|------------------------|-----------------|--|----|---|---|---|-----|--------|
| POWER ENTRY HARD WIRED | 01-HWPOWERENTRY |  | 72 | - | - | 1 | 0.2 | \$ 302 |
|------------------------|-----------------|--|----|---|---|---|-----|--------|

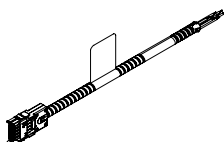

**Description**

- Eight (8) Wire/Four (4) Circuit Hard Wire In-feed
- UL183 Compliant

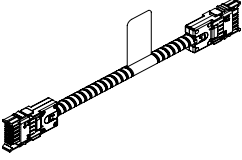
| Item  | Model No.  | Width | Depth | Height | Ship Wt | Cubic Ft | List Price |
|---|------------|-------|-------|--------|---------|----------|------------|
|  | 01-HW2JUMP | 24    | -     | -      | 1       | 0.2      | \$ 181     |
|   | 01-HW3JUMP | 36    | -     | -      | 1       | 0.2      | \$ 193     |
|   | 01-HW4JUMP | 48    | -     | -      | 1       | 0.2      | \$ 199     |
|   | 01-HW5JUMP | 60    | -     | -      | 1       | 0.2      | \$ 239     |
|   | 01-HW6JUMP | 72    | -     | -      | 1       | 0.2      | \$ 253     |

#### Description

- Eight (8) Wire/Four (4) Circuit Hard Wire Jumper
- UL183 Compliant

| Item  | Model No.     | Color  | Width | Depth | Height | Ship Wt | Cubic Ft | List Price |
|---|---------------|--------|-------|-------|--------|---------|----------|------------|
|  | 01-PDUOBEZELW | White  | 6½    | 2½    | 3      | 1       | 0.2      | \$ 626     |
|   | 01-PDUOBEZELB | Black  |       |       |        |         |          | \$ 626     |
|   | 01-PDUOBEZELS | Silver |       |       |        |         |          | \$ 626     |

#### Description

- Sits on Worksurface and Includes: Two (2) Power, Two (2) USB, 12" Cord, and All Mounting Hardware
- Requires Daisy Chain Power Box, Specified Separately, See Below
- Non-Sequential System Allows up to Eight (8) Modules to be Connected with Jumper Cord, [See Jumper Cords](#)
- Independent USB Circuit Controllers Deliver up to 2.1 Amps to Each Post
- FCC Part 15A, RU Listed and UL Recognized for Horizontal and Vertical Applications

| Item  | Model No.      | Color  | Width | Depth | Height | Ship Wt | Cubic Ft | List Price |
|---|----------------|--------|-------|-------|--------|---------|----------|------------|
|  | 01-PTRIOBEZELW | White  | 9     | 2½    | 3      | 1       | 0.2      | \$ 671     |
|   | 01-PTRIOBEZELB | Black  |       |       |        |         |          | \$ 671     |
|   | 01-PTRIOBEZELS | Silver |       |       |        |         |          | \$ 671     |

#### Description

- Sits on Worksurface and Includes: Three (3) Power, Two (2) USB, 1 Open Data, 12" Cord, and All Mounting Hardware
- HDMI, VGA, or RJ45 Accessory for Open Data Port Specified Separately, [See Accessories](#)
- Requires Daisy Chain Power Box, Specified Separately, See Below
- Non-Sequential System Allows up to Eight (8) Modules to be Connected with Jumper Cord, [See Jumper Cords](#)
- FCC Part 15A, RU Listed and UL Recognized for Horizontal and Vertical Applications

| Item  | Model No.  | Width                                 | Depth | Height | Ship Wt | Cubic Ft | List Price |
|---|------------|---------------------------------------|-------|--------|---------|----------|------------|
|  | 01-PPOWER  | -                                     | -     | -      | 1       | 0.2      | \$ 727     |
|   |            | <i>76" Perimeter, 36" Power Cord</i>  |       |        |         |          |            |
|   | 01-PPOWER2 | -                                     | -     | -      | 1       | 0.2      | \$ 747     |
|   |            | <i>24" Perimeter, 144" Power Cord</i> |       |        |         |          |            |

#### Description

- Powers up to Eight (8) Duo and Trio Daisy Chain Units
- One (1) Nema Plug and One (1) Daisy Chain Plug
- 12 Amp System Rating
- 15 Amp Over-Current Protection

[See Iconic Overview For Ordering Options](#)

| Item   | Model No. |                 | Width | Depth | Height | Ship Wt | Cubic Ft | List Price |
|--|-----------|-----------------|-------|-------|--------|---------|----------|------------|
| DAISY CHAIN JUMPER CORD<br> | 01-6JUMP  | <i>72" Long</i> | -     | -     | -      | 1       | 0.2      | \$ 281     |
|  | 01-5JUMP  | <i>60" Long</i> | -     | -     | -      | 1       | 0.2      | \$ 266     |
|  | 01-4JUMP  | <i>48" Long</i> | -     | -     | -      | 1       | 0.2      | \$ 225     |
|  | 01-2JUMP  | <i>24" Long</i> | -     | -     | -      | 1       | 0.2      | \$ 207     |

**Description**

- Connects Duo and Trio Daisy Chain Units
- Non Sequential System Allows up to Eight (8) Modules to be Connected

|   |             |  |   |   |   |   |     |        |
|---|-------------|--|---|---|---|---|-----|--------|
| HDMI DATA PORT ACCESSORY FOR TRIO UNITS | 01-LCOMHDMI |  | - | - | - | 1 | 0.2 | \$ 155 |
|---|-------------|--|---|---|---|---|-----|--------|

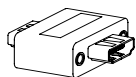



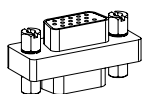

Open Market

|  |            |  |   |   |   |   |     |        |
|--|------------|--|---|---|---|---|-----|--------|
| VGA DATA PORT ACCESSORY FOR TRIO UNITS | 01-LCOMVGA |  | - | - | - | 1 | 0.2 | \$ 114 |
|--|------------|--|---|---|---|---|-----|--------|

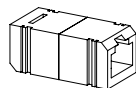

|   |             |  |   |   |   |   |     |       |
|---|-------------|--|---|---|---|---|-----|-------|
| RJ45 DATA PORT ACCESSORY FOR TRIO UNITS | 01-LCOMRJ45 |  | - | - | - | 1 | 0.2 | \$ 74 |
|---|-------------|--|---|---|---|---|-----|-------|

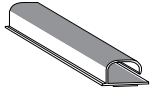
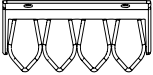

| Item   | Model No. | Width | Depth | Height | Ship Wt | Cubic Ft | List Price |
|--|-----------|-------|-------|--------|---------|----------|------------|
|  <p><b>VESTA POWER CENTER</b></p>   | 01-PDCTR  | 10 ¾  | 12    | 28¼    | 14      | 2.5      | \$ 1666    |
| <p><b>Description</b></p> <ul style="list-style-type: none"> <li>• Available in White</li> <li>• 120" Power Cord</li> <li>• Four (4) Power Outlets, Three (3) on the Base and One (1) on the Top</li> <li>• Two (2) USB Ports and One (1) USBC Port, All on Top</li> <li>• Built with Weight Distribution for Optimal Stability</li> <li>• Base is 5" Tall</li> </ul>  |           |       |       |        |         |          |            |
|  <p><b>WIRE CHANNEL</b></p>   | 01-32125  | 24    | 1½    | 1      | 0.25    | 0.3      | \$ 99      |
| <p><b>Description</b></p> <ul style="list-style-type: none"> <li>• Available in Black</li> <li>• Channels Attach with Two (2) Double-Sided Installation Tape</li> <li>• Easily Attach to an Iconic Leg to Route Wires/Cords from the Top to the Floor</li> <li>• Open J Channel for Easy Storage of Cables</li> </ul>  |           |       |       |        |         |          |            |
|  <p><b>CABLE GRIP</b></p>   | 01-WMGRCB | 5¾    | 2¾    | -      | -       | -        | \$ 16      |
| <p><b>Description</b></p> <ul style="list-style-type: none"> <li>• Under Surface Wire Management</li> <li>• Black</li> </ul>   |           |       |       |        |         |          |            |
|  <p><b>POWER STRIP</b></p>  | 01-PRSP   | 9     | 2     | 2      | 1       | -        | \$ 192     |
| <p><b>Description</b></p> <ul style="list-style-type: none"> <li>• Includes Four (4) Outlets and Two (2) Phone Jacks</li> <li>• Black Plastic with Rocker On/Off Switch</li> <li>• 13 Amp Circuit Breaker</li> <li>• 10' Power Cord and Two (2) 14' Phone Hook Up Cords</li> <li>• UL Listed and CSA Certified</li> <li>• Suitable for Surface or Recessed Mounting</li> <li>• Ships via UPS Only</li> </ul> |           |       |       |        |         |          |            |

[See Iconic Overview For Ordering Options](#)



Jefferson echoes history and creates a timeless foundation for today's sophisticated work place. Finely crafted in select solids with Walnut and Cherry veneers, the tailored details of this collection accentuate our expert craftsmanship and perfect attention to detail.

**CONSTRUCTION**

Jefferson features a Veneer chassis with your choice of a Veneer or HPL top. Units ship assembled unless otherwise noted.

**VENEER**

- Choose from premium or select veneer on exposed surfaces in American Black Walnut or Cherry species in bookmatched veneer faces
- Veneers are carefully selected and matched to assure proper balance and consistency

**TOPS**

- Veneer tops offer a 5-ply balanced construction, 1<sup>3</sup>/<sub>16</sub>" thick with solid hardwood mitered rims
- High Pressure Laminate (HPL) tops offer a 3-ply balanced construction, 1<sup>3</sup>/<sub>16</sub>" thick with solid hardwood mitered rims
- Grain direction runs left-to-right unless otherwise noted
- All Jefferson tops are standard with the Jefferson edge profile (C2), unless otherwise noted.



**CHASSIS**

- Chassis is securely fastened using high quality European fastening systems, heavy-duty, 16-gauge joining brackets and wood dowels to assure maximum strength
- Bases are solid hardwood with mitered corners
- All units have finished veneer backs
- Construction offers tight tolerances and long term durability
- All units equipped with heavy-duty, adjustable glides to ensure proper leveling and compensate for uneven floors
- Vertical grain direction on chassis

**DRAWERS**

- Drawer fronts standard with bookmatched veneer faces
- Fronts are 3-ply construction and 3/4" thick
- Drawer interiors are dovetail, wood constructed with 7/16" hardwood sides and backs and 5/32" thick hardboard bottoms
- All drawers feature full extension, progressive action slides with precision steel ball bearings
- Box and file drawers are tested for 100lb capacity; Lateral files have 1/4" thick bottoms and are tested for 200lb capacity
- All suspensions have a limited lifetime warranty
- Optional soft close ([see option details](#)) is available on box and file drawers, unless otherwise noted

**FILING**

- All file drawers are standard with filing systems designed to accommodate a variety of filing requirements
- Legal width file drawers provide legal filing front to back, and letter or legal filing side to side
- Letter width file drawers provide letter filing front to back, and letter or legal filing side to side

**STORAGE**

- All hinged doors include soft close hinges, unless noted
- Soft close hinges reduce stress placed on the cabinet when the door is closed and offers a quiet closure

**LOCKING**

- Locking is standard on credenzas and optional on wardrobe/cabinets
- Lock core color will coordinate with pull selection (brass pulls will have black cores, while aluminum pulls will have silver cores)
- Removable lock cylinders allow for units to be re-keyed at a later date if required
- Units are shipped randomly keyed as standard. Keyed alike units available upon request at no additional charge.

**INTERIOR DRAWER DIMENSIONS & FILING CAPABILITIES**

**Model**

46-2072SC1

**Drawers**

|      | <b>W</b>                         | <b>L</b>                          | <b>D</b>                          |
|------|----------------------------------|-----------------------------------|-----------------------------------|
| Box  | 15 <sup>3</sup> / <sub>8</sub> " | 16 <sup>7</sup> / <sub>32</sub> " | 3 <sup>2</sup> / <sub>32</sub> "  |
| File | 15 <sup>3</sup> / <sub>8</sub> " | 16 <sup>7</sup> / <sub>32</sub> " | 11 <sup>3</sup> / <sub>32</sub> " |

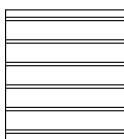

Legal Front to Back

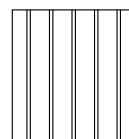

Legal Side to Side

**Model**

46-2072DL

**Drawers**

|      | <b>W</b>                         | <b>L</b>                         | <b>D</b>                         |
|------|----------------------------------|----------------------------------|----------------------------------|
| File | 12 <sup>3</sup> / <sub>8</sub> " | 25 <sup>3</sup> / <sub>4</sub> " | 8 <sup>1</sup> / <sub>32</sub> " |

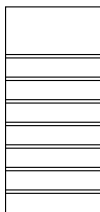

Letter Front to Back

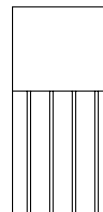

Legal Side to Side

**HOW TO ORDER EXAMPLES**

**CIRCULAR TOP**

| <b>MODEL #</b> | <b>QTY</b> | <b>DESCRIPTION</b> | <b>EXAMPLE</b> |
|----------------|------------|--------------------|----------------|
| 46-4848CT      | 1          | Top Material       | PV             |
|                |            | Finish/Color       | MW             |

**BASE**

|           |   |        |    |
|-----------|---|--------|----|
| 01-0606QB | 1 | Finish | MW |
|-----------|---|--------|----|

**CREDENZA**

|            |   |                            |      |
|------------|---|----------------------------|------|
| 46-2072SC1 | 1 | Premium or Standard Veneer | PV   |
|            |   | Top Material               | W    |
|            |   | Finish/Color               | MW   |
|            |   | Pull                       | JEF  |
|            |   | No Molding                 | -    |
|            |   | Drawer Track               | SOFT |

### PREMIUM AND STANDARD VENEER (W) OPTIONS

Veneer features UVAdvantage, an ultra-violet finish, on all exposed surfaces by utilizing roll-coat UV technology.

*Note: Base and decorative molding feature multi-step, hand-finished catalyzed finish.*

|     |                    |     |                     |
|-----|--------------------|-----|---------------------|
| AW  | Artisan Walnut     | HW  | Harvest Walnut      |
| CO  | Columbian Walnut   | LW  | Legacy Walnut       |
| DC  | Dark Cherry        | MW  | Mahogany Walnut     |
| DFW | Dark Forest Walnut | SCH | Select Cherry       |
| EW  | Espresso           | SKC | Shaker Cherry       |
| GC  | Golden Cherry      | WC  | Williamsburg Cherry |

### HPL (P) TOP OPTIONS

#### WOODGRAIN

|    |                  |     |                     |
|----|------------------|-----|---------------------|
| CO | Columbian Walnut | SCH | Select Cherry       |
| EF | Espresso         | SKC | Shaker Cherry       |
| GC | Golden Cherry    | WC  | Williamsburg Cherry |
| MW | Mahogany Walnut  |     |                     |

### DRAWER AND DOOR PULL OPTIONS

Units with doors and drawers will feature coordinating pulls however door and drawer pulls cannot be intermixed.

|     |                            |     |                          |
|-----|----------------------------|-----|--------------------------|
| ARA | Arlington A, Antique Brass | JEF | Jefferson, Antique Brass |
| ARB | Arlington B, Antique Brass | ALB | Liberty, Aluminum        |
| WLM | Wilmington, Antique Brass  |     |                          |



**Arlington A (ARA)**  
Antique Brass - 5¼"



**Arlington B (ARB)**  
Antique Brass - 5¼"



**Jefferson (JEF)**  
Antique Brass - 5¼"



**Wilmington (WLM)**  
Antique Brass - 5¼"



**Liberty (ALB)**  
Aluminum - 4¼"

### DRAWER TRACK OPTIONS

Soft close tracks are available on center, tray, box, and file drawers in Jefferson. Soft close drawer tracks have many benefits including reduced stress on the unit, extends the life of the drawer, and ensures a gentle close so fingers don't accidentally get hurt. Must specify when ordering.

**Pricing is per Drawer, not per Model/Unit**

|       |                         |    |    |
|-------|-------------------------|----|----|
| SFTCL | Soft Close Drawer Track | \$ | 32 |
|-------|-------------------------|----|----|

### MOLDING OPTIONS

All credenzas ship with decorative pencil molding. If you do not want molding, please specify "NO MOLDING" when ordering each model.

*Note: Base and decorative molding feature multi-step, hand-finished catalyzed finish.*

### LOCKING DOORS

Locking doors are available on wardrobe/cabinets. Specify WITH LOCKING when ordering and add upcharge. Lock core will coordinate with pull selection.

|        |                    |    |    |
|--------|--------------------|----|----|
| LKT_HU | 36"W to 32"W Units | \$ | 85 |
| LKT_HU | 18"W Units         | \$ | 65 |

### CERTIFICATIONS & COMPLIANCE

- Intertek Sustainability Certified
- BIFMA level® Certified
- BIFMA Compliant Certified
- TSCA Title VI (formerly CARB) Compliance
- US Green Building's LEED Contribution

### STATEMENT OF LINE



Circular Tables and Bases  
[\(See Details\)](#)

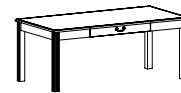
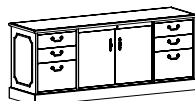
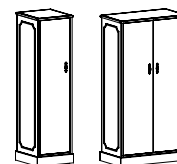

Table Desks  
[\(See Details\)](#)



Storage Credenza [\(See Details\)](#)  
Double Lateral Credenza  
[\(See Details\)](#)



Single Wardrobe/Storage Cabinet  
[\(See Details\)](#)  
Double Wardrobe/Storage Cabinet  
[\(See Details\)](#)

For additional solutions for desking, storage, and accessories, see the [Jefferson Casegoods](#) and [Accessories](#) Price Lists.

| Item   | Model No.   | Width | Depth | Height                          | Ship Wt | Cubic Ft | List Price              |
|--|---|-------|-------|---------------------------------|---------|----------|-------------------------|
|  <p>Top Must Specify (in this order):<br/>Model #<br/>Top Material<br/>Finish/Color</p> <p>Base Must Specify (in this order):<br/>Model #<br/>Premium or Standard Veneer (if applicable)<br/>Finish</p> | 46-4848CT<br><i>Accommodates Five (5) Chairs</i>  | 48    | 48    | 13 <sup>1</sup> / <sub>16</sub> | 58      | 5.9      | W/P\$ 4021<br>PV\$ 4504 |
|  | 46-4242CT<br><i>Accommodates Four (4) Chairs</i>  | 42    | 42    | 13 <sup>1</sup> / <sub>16</sub> | 51      | 4.5      | W/P\$ 3499<br>PV\$ 3919 |
|  | 46-3636CT<br><i>Accommodates Three (3) Chairs</i> | 36    | 36    | 13 <sup>1</sup> / <sub>16</sub> | 43      | 3.3      | W/P\$ 3152<br>PV\$ 3530 |

### Description

- Top Available with Premium/Standard Veneer (PV/W) or HPL (P); Must Specify
- See Below for Base Options, Order Separately; One (1) Required
- Power Options not Available

### Base Options: Must Order & Add



#### Queen Anne Base

|           |                     |    |    |                                |     |      |         |
|-----------|---------------------|----|----|--------------------------------|-----|------|---------|
| 01-0606QB | Must Specify Finish | 20 | 20 | 28 <sup>3</sup> / <sub>4</sub> | 136 | 11.1 | \$ 1318 |
|-----------|---------------------|----|----|--------------------------------|-----|------|---------|

### Description

- Classic Design Detail on Column
- Queen Anne Base Features Multi-Step, Hand-Finished Catalyzed Finish
- Four Legs with Adjustable Glides



#### Cylinder Bases

|           |                               |    |    |                                |     |      |                       |
|-----------|-------------------------------|----|----|--------------------------------|-----|------|-----------------------|
| 01-2020CB | For Use with 48" and 42" Tops | 20 | 20 | 28 <sup>3</sup> / <sub>4</sub> | 136 | 11.1 | W\$ 1456<br>PV\$ 1701 |
| 01-1616CB | For Use with 36" Tops         | 16 | 16 | 28 <sup>3</sup> / <sub>4</sub> | 101 | 7.2  | W\$ 1331<br>PV\$ 1557 |

### Description

- Premium Veneer (PV) or Standard Veneer (W) Cylinder Base; Weighted for Stability
- Cylinder Base Features Multi-Step, Hand-Finished Catalyzed Finish
- Two (2) Black Wire Management Grommets at Top and One (1) 8" Wire Management Opening in Bottom

### Options: Specify & Add

|       |  |     |
|-------|--|-----|
| GCB1S | Single Grommet at Top Edge (Factory Installed) | N/C |
| NOGC  | No Grommet at Top Edge                         | N/C |



#### Height Adjustable Pneumatic X-Bases

##### Maximum Round 42", Maximum Square 36"

|              |          |    |    |                                   |   |     |         |
|--------------|----------|----|----|-----------------------------------|---|-----|---------|
| 01-3232HAXBB | Black    | 32 | 32 | 26-45 <sup>3</sup> / <sub>4</sub> | 1 | 0.2 | \$ 1615 |
| 01-3232HAXBA | Aluminum | 32 | 32 | 26-45 <sup>3</sup> / <sub>4</sub> | 1 | 0.2 | \$ 1615 |

##### Maximum Round 36", Maximum Square 30"

|              |          |    |    |                                   |   |     |         |
|--------------|----------|----|----|-----------------------------------|---|-----|---------|
| 01-2626HAXBB | Black    | 22 | 22 | 26-45 <sup>3</sup> / <sub>4</sub> | 1 | 0.2 | \$ 1583 |
| 01-2626HAXBA | Aluminum | 22 | 22 | 26-45 <sup>3</sup> / <sub>4</sub> | 1 | 0.2 | \$ 1583 |

### Description

- Pre-Drilled Boring Pattern May Not Match Underside of Table Top
- Steel Mounting Plate: 8" x 8" x 1/4"
- Eight (8) \*MM Bolts Included for Assembly
- Ships KD

P = HPL W = Veneer PV = Premium Veneer

[See Jefferson Overview For Ordering Options](#)

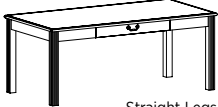
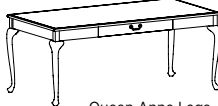
| Item   | Model No.                   | Width | Depth | Height | Ship Wt | Cubic Ft | List Price              |  |
|--|-----------------------------|-------|-------|--------|---------|----------|-------------------------|--|
| <p><b>TABLE DESK</b></p>  <p>Straight Legs</p>  <p>Queen Anne Legs</p> | <b>WITH STRAIGHT LEGS</b>   |       |       |        |         |          |                         |  |
|  | 46-3672TD                   | 72    | 36    | 30     | 120     | 12.2     | W/P\$ 3729<br>PV\$ 4177 |  |
|  | 46-3066TD                   | 66    | 30    | 30     | 110     | 9.7      | W/P\$ 3120<br>PV\$ 3496 |  |
|  | <b>WITH QUEEN ANNE LEGS</b> |       |       |        |         |          |                         |  |
|  | 46-3672TDQ                  | 72    | 36    | 30     | 120     | 12.2     | W/P\$ 5935<br>PV\$ 6383 |  |
|  | 46-3066TDQ                  | 66    | 30    | 30     | 110     | 9.7      | W/P\$ 5326<br>PV\$ 5702 |  |

Must Specify (in this order):

- Model #
- Top Material
- Finish/Color
- Pull
- Drawer Track

**Description**

- Standard with: Rectangle Top Profiled on All Sides, Center Drawer with Dovetail Wood Drawer Construction, and Left-to-Right Grain Direction on Top
- Top Available with Premium Veneer (PV), Veneer (W), or HPL (P); Must Specify
- Top and Legs Ship Separately; Some Assembly Required
- Additional Option: Soft Close Drawer Closure ([See Drawer Options](#))

|                                |           |    |    |    |     |      |                         |
|--------------------------------|-----------|----|----|----|-----|------|-------------------------|
| <b>DOUBLE LATERAL CREDENZA</b> | 46-2072DL | 72 | 20 | 30 | 304 | 29.0 | W/P\$ 7064<br>PV\$ 7911 |
|--------------------------------|-----------|----|----|----|-----|------|-------------------------|

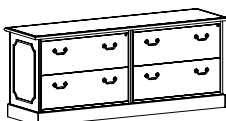

With Decorative Molding

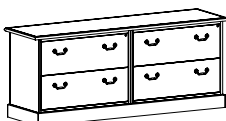

Without Decorative Molding

**Description**

- Standard With: Rectangle Top Profiled on All Sides, Base Molding on All Sides, Decorative Molding on Both Sides, Dual Locking Double Lateral/Lateral Peds with Legal or Letter Filing, Front-to-Back Grain Direction on Top, Dovetail Wood Drawer Construction, and Anti-Tilt System
- Chassis Available with Premium Veneer (PV) or Standard Veneer (W); Must Specify
- Top Available with Premium/Standard Veneer (PV/W) or HPL (P); Must Specify
- Lock Core Color will Coordinate with Pull Selection (Brass Pull with Black Lock, Silver Pull with Silver Lock)
- Additional Options: No Decorative Molding (Specify NO MOLDING)

Must Specify (in this order):

- Model #
- Premium or Standard Veneer
- Top Material
- Finish/Color
- Pull
- No Molding

P = HPL W = Veneer PV = Premium Veneer

[See Jefferson Overview For Ordering Options](#)

| Item                               | Model No.                       | Width | Depth | Height | Ship Wt | Cubic Ft | List Price              |
|------------------------------------|---------------------------------|-------|-------|--------|---------|----------|-------------------------|
| STORAGE CREDENZA WITH BOX/BOX/FILE | 46-2072SC1<br><i>Legal Ped</i>  | 72    | 20    | 30     | 296     | 29.0     | W/P\$ 6486<br>PV\$ 7265 |
|                                    | 46-2066SC1<br><i>Letter Ped</i> | 66    | 20    | 30     | 296     | 29.0     | W/P\$ 5837<br>PV\$ 6536 |

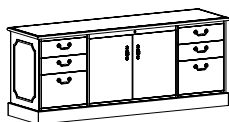

With Decorative Molding

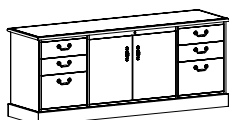

Without Decorative Molding

**Description**

- Standard With: Rectangle Top Profiled on All Sides, Central Locking, Base Molding on All Sides, Decorative Molding on Both Sides, Box/Box/File Peds with Legal or Letter Filing, One Fixed Shelf Behind Doors, Front-to-Back Grain Direction on Top, and Dovetail Wood Drawer Construction
- Chassis Available with Premium Veneer (PV) or Standard Veneer (W); Must Specify
- Top Available with Premium/Standard Veneer (PV/W) or HPL (P); Must Specify
- Lock Core Color will Coordinate with Pull Selection (Brass Pull with Black Lock, Silver Pull with Silver Lock)
- Additional Options: No Decorative Molding (Specify NO MOLDING); Soft Close Drawer Closure ([See Drawer Options](#))

Must Specify (in this order):

- Model #
- Premium or Standard Veneer
- Top Material
- Finish/Color
- Pull
- No Molding
- Drawer Track

| SINGLE WARDROBE/<br>STORAGE CABINET | Left Hinged | Right Hinged | Width | Depth | Height | Ship Wt | Cubic Ft | List Price            |
|-------------------------------------|-------------|--------------|-------|-------|--------|---------|----------|-----------------------|
|                                     | 46-1870WL   | 46-1870WR    | 18    | 20    | 69 1/8 | 155     | 17.2     | W\$ 5056<br>PV\$ 5662 |

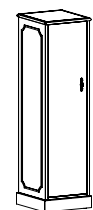

With Decorative Molding

Shown as Left Hinged



Without Decorative Molding

**Description**

- Standard With: Top Profiled on All Sides, Base Molding on All Sides, Decorative Molding on Both Sides, Fixed Top Shelf Behind Door, Coat Rod Under Fixed Shelf, Three (3) Adjustable Shelves Behind Door
- Available in Premium Veneer (PV) or Standard Veneer (W); Must Specify
- Adjustable Shelves Can Be Easily Removed for Wardrobe Application
- Additional Options: No Decorative Molding (Specify NO MOLDING); Locking Door ([See Locking Options](#))

Must Specify (in this order):

- Model #
- Premium or Standard Veneer
- Finish
- Pull
- No Molding
- Locking Door

P = HPL W = Veneer PV = Premium Veneer

[See Jefferson Overview For Ordering Options](#)

| Item                                | Model No. | Width | Depth | Height | Ship Wt | Cubic Ft | List Price             |
|-------------------------------------|-----------|-------|-------|--------|---------|----------|------------------------|
| DOUBLE WARDROBE/<br>STORAGE CABINET | 46-3670WD | 36    | 20    | 69½    | 310     | 34.2     | W\$ 8924<br>PV\$ 9995  |
|                                     | 46-3270WD | 32    | 24    | 69½    | 310     | 34.2     | W\$ 9164<br>PV\$ 10265 |

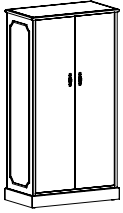

With Decorative  
Molding

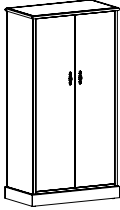

Without Decorative  
Molding

### Description

- Standard With: Top Profiled on All Sides, Base Molding on All Sides, Decorative Molding on Both Sides, Fixed Top Shelf Behind Each Door, Coat Rod Under Each Fixed Shelf, Three (3) Adjustable Shelves Behind Each Door
- Available in Premium Veneer (PV) or Standard Veneer (W); Must Specify
- Adjustable Shelves Can Be Easily Removed for Wardrobe Application
- Additional Options: No Decorative Molding (Specify NO MOLDING); Locking Doors ([See Locking Options](#))

### Must Specify (in this order):

Model #  
Premium or Standard Veneer  
Finish  
Pull  
No Molding  
Locking Door

P = HPL W = Veneer PV = Premium Veneer

[See Jefferson Overview For Ordering Options](#)

Madera creates a variety of looks from rich, refined transitional to fresh, modern contemporary by offering an abundance of options, including premium veneer. Finely crafted in select Cherry, Maple, Walnut, and Oak veneers, Madera features a UV topcoat on all exposed surfaces adding unsurpassed hardness and extreme durability for long lasting office applications.

### CONSTRUCTION

Madera features a Veneer chassis with your choice of either a Veneer or HPL top. Units ship assembled unless otherwise noted.

### VENEER

- Choose from premium veneer or select veneer on exposed surfaces in American Black Walnut, White Oak, Cherry, or Maple species
- The American Black Walnut, White Oak, and Cherry veneers are book matched veneer faces, while the Maple is a slip-matched veneer face
- These veneers are carefully selected and matched to assure proper balance and consistency

### TOPS

- Wood Veneer tops have a 5-ply balanced construction while High Pressure Laminate (HPL) tops have a 3-ply balanced construction, 1 $\frac{3}{16}$ " thick, with hardwood rims
- Tops featuring the Bullnose (D), Tri-Round (E), Flute (X), and Square (Y) edge profiles have vertical profiles
- Tops featuring the Radius (A) and Bevel (B) edge profiles have the same construction, but provide a matching reverse profile on connecting edge
- Grain direction runs left to right unless otherwise noted

### CHASSIS

- Tops, end panels, and modesty panels are securely fastened using high quality European style fastening systems and heavy-duty, 16-gauge joining brackets to assure maximum strength
- All units are equipped with heavy-duty, adjustable glides to ensure proper leveling and compensation for uneven floors

### DRAWERS

- All drawer fronts are standard with matched faces
- All drawers feature 5-sided construction allowing for easy removal of drawer fronts
- Fronts are 3-ply construction and are  $\frac{3}{4}$ " thick with matched grain
- Drawer interiors are dovetail construction with  $\frac{7}{16}$ " thick hardwood sides and backs and  $\frac{5}{32}$ " thick hardboard bottoms
- The drawer interiors are sanded, sealed, and finished to provide a smooth, quality feel and appearance
- All drawers feature full extension, progressive action slides with precision steel ball bearings
- Box and file drawers are tested for 100lb capacity
- Lateral files are tested for 200lb capacity
- All suspensions have a limited lifetime warranty

### FILING

- All file drawers are standard with filing systems designed to accommodate a variety of filing requirements
- Letter width file drawers provide letter filing front to back and legal filing side to side
- Lateral file drawers provide legal or letter filing front to back or side to side

### STORAGE

- All hinged doors include soft close hinges, unless noted
- One piece hinge and base plate combination
- Soft close hinges reduce stress placed on the cabinet when the door is closed and offers a quiet closure

### LOCKING

- All credenzas feature locking file drawers; optional locking doors is available on select units
- Removable lock cylinders allow for units to be re-keyed at a later date, if required
- Units are shipped randomly keyed as standard
- Keyed alike units available upon request at no additional charge
- Lock core will match pull color

### CORD MANAGEMENT

- Grommets are available in black or silver, please specify color

### INTERIOR DRAWER DIMENSIONS & FILING CAPABILITIES

#### Models

16-2472SC      16-2072SC

#### Drawers

File

#### W

15 $\frac{1}{32}$ "

#### L

16 $\frac{1}{4}$ "

#### D

8 $\frac{29}{32}$ "

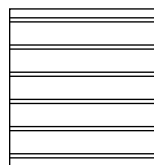

Legal Front to Back

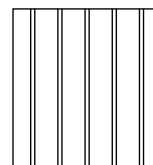

Legal Side to Side

#### Models

16-2466SC

#### Drawers

File

#### W

12 $\frac{1}{32}$ "

#### L

16 $\frac{1}{4}$ "

#### D

8 $\frac{29}{32}$ "

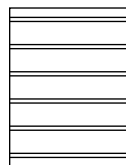

Letter Front to Back

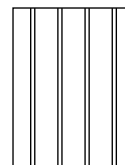

Legal Side to Side

#### Models

14-2072SC

#### Drawers

Box

#### W

15 $\frac{1}{32}$ "

#### L

16 $\frac{1}{4}$ "

#### D

3 $\frac{21}{32}$ "

File

15 $\frac{1}{32}$ "

16 $\frac{1}{4}$ "

8 $\frac{29}{32}$ "

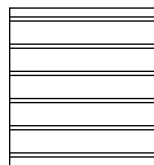

Legal Front to Back

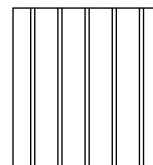

Legal Side to Side

**INTERIOR DRAWER DIMENSIONS & FILING CAPABILITIES (CONTINUED)**

**Models**

14-3670WD2L 14-3670WD2R

**Drawers**

File **W** **L** **D**  
14<sup>9</sup>/<sub>32</sub>" 16<sup>1</sup>/<sub>4</sub>" 8<sup>29</sup>/<sub>32</sub>"



Letter Front to Back

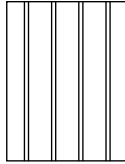

Legal Side to Side

**Models**

14-3670WD1L 14-3670WD1R

**Drawers**

Box **W** **L** **D**  
14<sup>9</sup>/<sub>32</sub>" 16<sup>1</sup>/<sub>4</sub>" 3<sup>2</sup>/<sub>32</sub>"  
File 14<sup>9</sup>/<sub>32</sub>" 16<sup>1</sup>/<sub>4</sub>" 8<sup>29</sup>/<sub>32</sub>"



Letter Front to Back

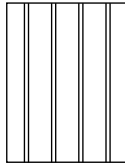

Legal Side to Side

**Models**

14-3670SU2

**Drawers**

Lateral **W** **L** **D**  
32<sup>9</sup>/<sub>32</sub>" 16<sup>1</sup>/<sub>4</sub>" 8<sup>29</sup>/<sub>32</sub>"

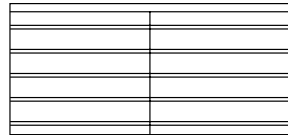

2 Rows Letter Front to Back

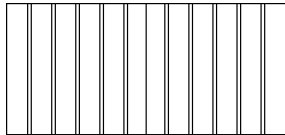

1 Row Legal Side to Side

**HOW TO ORDER EXAMPLES**

|                   | Model No.   | QTY | Description             | Example      |
|-------------------|-------------|-----|-------------------------|--------------|
| <b>TABLE TOP</b>  | 14-4848CT   | 1   | Top Material            | PV           |
|                   |             |     | Finish/Color            | MO           |
|                   |             |     | Edge Profile            | X            |
| <b>BASE</b>       | 01-2228STR4 | 1   | Color                   | ALUM         |
| <b>WORK TABLE</b> | 14-3672WT   | 1   | Premium/Standard Veneer | W            |
|                   |             |     | Top Material            | P            |
|                   |             |     | Finish/Color            | SM           |
|                   |             |     | Edge Profile            | Y            |
| <b>CREDENZA</b>   | 16-2472SC   | 1   | Premium/Standard Veneer | PV           |
|                   |             |     | Top Material            | P            |
|                   |             |     | Finish/Color            | HVM          |
|                   |             |     | Edge Profile            | B            |
|                   |             |     | Pull                    | ABM          |
| <b>WARDROBE</b>   | 14-3670WD1L | 1   | Premium/Standard Veneer | W            |
|                   |             |     | Finish/Color            | HW           |
|                   |             |     | Edge Profile            | D            |
|                   |             |     | Pull                    | AQD          |
|                   |             |     | Locking Door            | WITH LOCKING |

**PREMIUM VENEER (PV) AND VENEER (W) OPTIONS**

Veneer features UVAdvantage, an ultra-violet finish, on all exposed surfaces by utilizing roll-coat UV technology

|     |                    |     |                     |
|-----|--------------------|-----|---------------------|
| AW  | Artisan Walnut     | HW  | Harvest Walnut      |
| CO  | Columbian Walnut   | LW  | Legacy Walnut       |
| DC  | Dark Cherry        | MW  | Mahogany Walnut     |
| DFW | Dark Forest Walnut | MO  | Medium Oak*         |
| EW  | Espresso           | SCH | Select Cherry       |
| FO  | Fawn Oak*          | SKC | Shaker Cherry       |
| GC  | Golden Cherry      | SM  | Sugar Maple         |
| HVM | Harvest Maple      | WC  | Williamsburg Cherry |

\* Finish is Low Sheen

**HPL (P) LAMINATE WORKSURFACE OPTIONS**

**WOODGRAIN**

|     |                  |     |                     |
|-----|------------------|-----|---------------------|
| CO  | Columbian Walnut | SCH | Select Cherry       |
| EF  | Espresso         | SKC | Shaker Cherry       |
| GC  | Golden Cherry    | SM  | Sugar Maple         |
| HVM | Harvest Maple    | WC  | Williamsburg Cherry |
| MW  | Mahogany Walnut  |     |                     |



### PULL OPTIONS

Note: Lock Core will match Pull Color

|     |                  |     |                  |
|-----|------------------|-----|------------------|
| AAC | Arc, Aluminum    | AEL | Elite, Aluminum  |
| BAC | Arc, Black       | BEL | Elite, Black     |
| ABM | Beam, Aluminum   | FPL | Finger           |
| BBM | Beam, Black      | AFL | Flair, Aluminum  |
| BBT | Bow Tie, Black   | CFL | Flair, Chrome    |
| NBT | Bow Tie, Nickel  | AFC | Focus, Aluminum  |
| ABU | Buckle, Aluminum | BFC | Focus, Black     |
| BBU | Buckle, Black    | AQD | Quadra, Aluminum |
|     |                  | BQD | Quadra, Black    |

### CERTIFICATIONS & COMPLIANCE

- Intertek Sustainability Certified
- BIFMA level® Certified
- BIFMA Compliant® Certified
- TSCA Title VI (Formerly CARB) Compliance
- US Green Building's LEED® Contribution

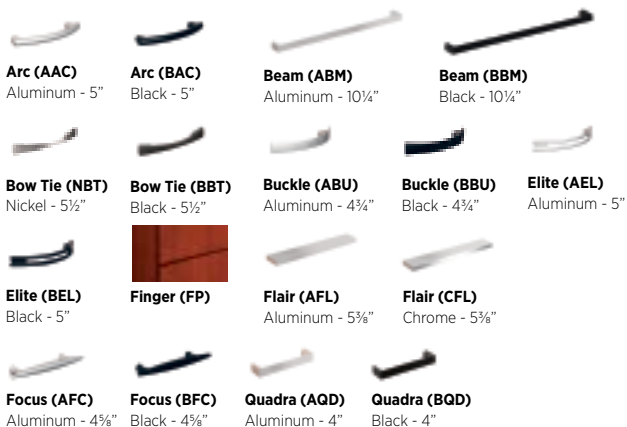

### EDGE PROFILES

|   |          |   |           |
|---|----------|---|-----------|
| B | Bevel    | A | Radius    |
| D | Bullnose | Y | Square    |
| X | Flute    | E | Tri-Round |



### LOCKING DOORS

Locking doors are available on select units. You must specify WITH LOCKING when ordering and add upcharge.

|        |            |       |
|--------|------------|-------|
| LKT_HU | 36"W Units | \$ 85 |
| LKT_HU | 18"W Units | \$ 65 |

**Tops and Tables**



Circular Tops  
[\(See Details\)](#)

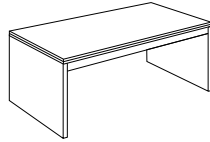

Work/Landing Tables  
[\(See Details\)](#)

**Bases**

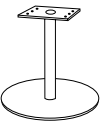

Disc Bases  
[\(See Details\)](#)

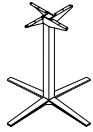

Small and Large X  
Bases [\(See Details\)](#)

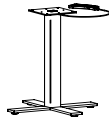

HA Pneumatic X Bases  
[\(See Details\)](#)



Metal Bases  
[\(See Details\)](#)



Strut Legs  
[\(See Details\)](#)



Cylinder Bases  
[\(See Details\)](#)

**Storage Components**

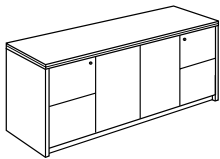

Full & 3/4 Ped Storage Credenzas  
[\(See Details\)](#)

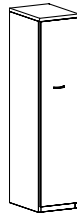
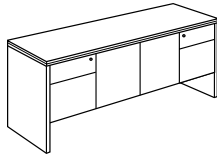

Wardrobe/Storage  
[\(See Details\)](#)

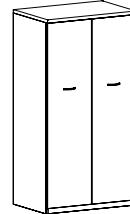

Double Wardrobe/Storage  
[\(See Details\)](#)

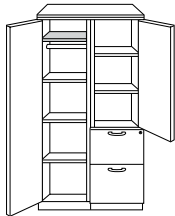

Double Wardrobe/Storage  
with File/File  
[\(See Details\)](#)



Double Wardrobe/Storage  
with Box/Box/File  
[\(See Details\)](#)

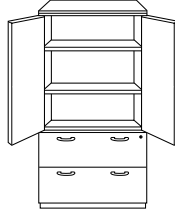

Double Wardrobe/Storage  
with Lateral Files  
[\(See Details\)](#)

For additional solutions for desking, storage, and accessories, see the [Madera Casegoods](#) and [Accessories](#) Price Lists.

| Item  | Model No.   | Width | Depth | Height | Ship Wt | Cubic Ft | List Price              |
|---|---|-------|-------|--------|---------|----------|-------------------------|
|  | 14-4848CT<br><i>Accommodates Five (5) Chairs</i>              | 48    | 48    | 30     | 60      | 5.7      | W/P\$ 2698<br>PV\$ 3154 |
|   | 14-4242CT<br><i>Accommodates Four (4) Chairs</i>              | 42    | 42    | 30     | 40      | 4.4      | W/P\$ 2447<br>PV\$ 2864 |
|   | 14-3636CT<br><i>Accommodates Three (3) to Four (4) Chairs</i> | 36    | 36    | 30     | 35      | 3.4      | W/P\$ 2148<br>PV\$ 2512 |

Must Specify (in this order):

- Model #
- Top Material
- Finish/Color
- Edge Profile

**Description**

- Available with Premium/Standard Veneer (PV/W) or HPL (P) Top, Must Specify
- Single Base or Four (4) Strut Legs (on 48" Top Only) Required; Ordered Separately, [See Strut Leg Details](#)
- Power Options not Available

**DISC BASE**

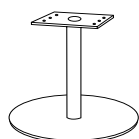

| For 48" Circular Tops         |          |    |    |     |    |     |         |  |
|-------------------------------|----------|----|----|-----|----|-----|---------|--|
| 01-3230DBB                    | Black    | 30 | 30 | 27¾ | 42 | 4.1 | \$ 1728 |  |
| 01-3230DBA                    | Aluminum | 30 | 30 | 27¾ | 42 | 4.1 | \$ 1728 |  |
| For 36" and 42" Circular Tops |          |    |    |     |    |     |         |  |
| 01-2430DBB                    | Black    | 24 | 24 | 27¾ | 32 | 3.2 | \$ 1440 |  |
| 01-2430DBA                    | Aluminum | 24 | 24 | 27¾ | 32 | 3.2 | \$ 1440 |  |

**Description**

- 4" Diameter Column

**METAL X-BASE**

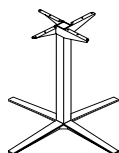

| For 42" and 48" Circular Tops |          |     |     |    |    |      |         |  |
|-------------------------------|----------|-----|-----|----|----|------|---------|--|
| 08-2642LXB                    | Aluminum | 35½ | 35½ | 40 | 33 | 20.0 | \$ 1240 |  |
| <i>For 42" High Tables</i>    |          |     |     |    |    |      |         |  |
| 08-2636LXB                    | Aluminum | 35½ | 35½ | 34 | 30 | 17.2 | \$ 1196 |  |
| <i>For 36" High Tables</i>    |          |     |     |    |    |      |         |  |
| 08-2630LXB                    | Aluminum | 35½ | 35½ | 28 | 27 | 14.5 | \$ 1144 |  |
| <i>For 30" High Tables</i>    |          |     |     |    |    |      |         |  |
| For 36" Circular Tops         |          |     |     |    |    |      |         |  |
| 08-2042SXB                    | Aluminum | 29½ | 29½ | 40 | 27 | 15.9 | \$ 1158 |  |
| <i>For 42" High Tables</i>    |          |     |     |    |    |      |         |  |
| 08-2036SXB                    | Aluminum | 29½ | 29½ | 34 | 24 | 13.7 | \$ 1112 |  |
| <i>For 36" High Tables</i>    |          |     |     |    |    |      |         |  |
| 08-2030SXB                    | Aluminum | 29½ | 29½ | 28 | 21 | 11.6 | \$ 1068 |  |
| <i>For 30" High Tables</i>    |          |     |     |    |    |      |         |  |

**Description**

- Not Available to Be Sold Separately

**HEIGHT ADJUSTABLE  
PNEUMATIC X-BASE**

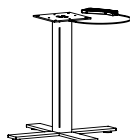

| Maximum Round 42", Maximum Square 36" |          |    |    |        |   |     |         |  |
|---------------------------------------|----------|----|----|--------|---|-----|---------|--|
| 01-3232HAXBB                          | Black    | 32 | 32 | 26-45¾ | 1 | 0.2 | \$ 1615 |  |
| 01-3232HAXBA                          | Aluminum | 32 | 32 | 26-45¾ | 1 | 0.2 | \$ 1615 |  |
| Maximum Round 36", Maximum Square 30" |          |    |    |        |   |     |         |  |
| 01-2626HAXBB                          | Black    | 22 | 22 | 26-45¾ | 1 | 0.2 | \$ 1583 |  |
| 01-2626HAXBA                          | Aluminum | 22 | 22 | 26-45¾ | 1 | 0.2 | \$ 1583 |  |

**Description**

- Pre-Drilled Boring Pattern May Not Match Underside of Table Top
- Steel Mounting Plate: 8"x 8"x ¼"
- Eight (8) \*MM Bolts Included for Assembly
- Ships KD

P = HPL W = Veneer PV = Premium Veneer

[See Madera Overview For Ordering Options](#)

| Item       | Model No.  |          | Width | Depth | Height | Ship Wt | Cubic Ft | List Price |
|------------|------------|----------|-------|-------|--------|---------|----------|------------|
| METAL BASE | 01-0400MBB | Black    | 32    | 32    | 27¾    | 32      | 3.2      | \$ 936     |
|            | 01-0400MBA | Aluminum | 32    | 32    | 27¾    | 32      | 3.2      | \$ 936     |



Open Market Only

**Description**  
 • Shipped KD; Some Assembly Required

|                  |             |                 |    |     |     |    |     |         |
|------------------|-------------|-----------------|----|-----|-----|----|-----|---------|
| STRUT TABLE LEGS | 01-2228STR4 | 2 Pair (4 Legs) | 1½ | 22½ | 28¾ | 64 | 9.0 | \$ 2398 |
|------------------|-------------|-----------------|----|-----|-----|----|-----|---------|

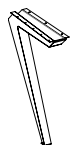

Must Specify (in this order):  
 Model # and Quantity  
 Color

**Description**  
 • Available in Aluminum (ALUM) or Black (BLK); Must Specify Color  
 • Each Leg has Adjustable Glides  
 • Legs not Available To Be Sold Separately  
 • For Use with Indiana Furniture Tops Only; Not For Use with 36" or 42" Circular Tops

|               |   |  |    |    |     |     |      |                       |
|---------------|---|--|----|----|-----|-----|------|-----------------------|
| CYLINDER BASE | 01-2020CB                                   |  | 20 | 20 | 28½ | 136 | 11.1 | W\$ 1456<br>PV\$ 1701 |
|               | <i>For Use With 42" or 48" Circular Top</i> |  |    |    |     |     |      |                       |
|               | 01-1616CB                                   |  | 16 | 16 | 28½ | 101 | 7.2  | W\$ 1331<br>PV\$ 1557 |
|               | <i>For Use With 36" Circular Top</i>        |  |    |    |     |     |      |                       |

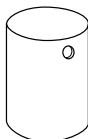

Must Specify (in this order):  
 Model  
 Finish/Color  
 Grommet  
 Grommet Color

**Description**  
 • Veneer Cylinder Base Features Multi-Step, Hand-Finished Catalyzed Finish  
 • Weighted for Stability  
 • Two (2) Wire Management Black Grommets Standard at Top with 8" Opening Standard in Bottom

| Options: Specify & Add |                            |     |
|------------------------|----------------------------|-----|
| GCBIS                  | Single Grommet at Top Edge | N/C |
| NOGC                   | No Grommets                | N/C |

|                             |                   |  |    |    |    |     |      |                         |
|-----------------------------|-------------------|--|----|----|----|-----|------|-------------------------|
| WORK TABLE<br>SEATED HEIGHT | 14-3672WT         |  | 72 | 36 | 30 | 195 | 50.0 | W/P\$ 3001<br>PV\$ 3510 |
|                             | Kneespace - 69 1¼ |  |    |    |    |     |      |                         |
|                             | 14-3060WT         |  | 60 | 30 | 30 | 134 | 35.5 | W/P\$ 2348<br>PV\$ 2750 |
|                             | Kneespace - 57 1¼ |  |    |    |    |     |      |                         |

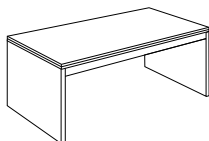

Must Specify (in this order):  
 Model #  
 Premium or Standard Veneer  
 Top Material  
 Finish/Color  
 Edge Profile

**Description**  
 • Solid End Panels with Apron Rail  
 • Available with Premium Veneer (PV), Standard Veneer (W) or HPL (P) Tops with Veneer Chassis; Must Specify  
 • Ships Fully Assembled

P = HPL W = Veneer PV = Premium Veneer

[See Madera Overview For Ordering Options](#)

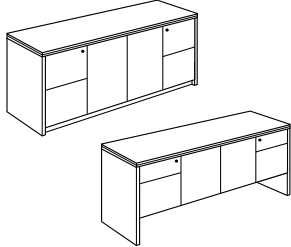
| Item  | Model No.             | Width | Depth | Height | Ship Wt | Cubic Ft | List Price              |
|---|-----------------------|-------|-------|--------|---------|----------|-------------------------|
|  | <b>Full Pedestals</b> |       |       |        |         |          |                         |
|   | 16-2472SC             | 72    | 24    | 30     | 285     | 35.6     | W/P\$ 5647<br>PV\$ 5401 |
|   | 16-2466SC             | 66    | 24    | 30     | 261     | 32.7     | W/P\$ 5168<br>PV\$ 5401 |
|   | 16-2072SC             | 72    | 20    | 30     | 270     | 30.5     | W/P\$ 5330<br>PV\$ 5401 |
|   | <b>¾ Pedestals</b>    |       |       |        |         |          |                         |
|   | 14-2072SC             | 72    | 20    | 30     | 227     | 30.5     | W/P\$ 4615<br>PV\$ 5401 |

Must Specify (in this order):

- Model #
- Premium or Standard Veneer
- Top Material
- Finish/Color
- Edge Profile
- Pull

**Description**

- Legal Width, Locking File/File Pedestals (Full) and Legal Width, Locking Box/File Pedestals (¾)
- Fixed Storage Shelf Behind Doors
- Available with Premium Veneer (PV), Standard Veneer (W) or HPL (P) Tops with Veneer Chassis; Must Specify
- Lock Core will Coordinate with Pull Selection

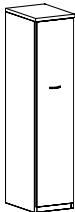
| WARDROBE/STORAGE CABINET   | Left Hinged | Right Hinged | Width | Depth | Height | Ship Wt | Cubic Ft | List Price            |
|--|-------------|--------------|-------|-------|--------|---------|----------|-----------------------|
|  | 14-1870WL   | 14-1870WR    | 18    | 24    | 69¾"   | 153     | 19.2     | W\$ 4937<br>PV\$ 5778 |
|  | 14-1870CL   | 14-1870CR    | 18    | 20    | 69¾"   | 150     | 18.6     | W\$ 4178<br>PV\$ 4886 |

Shown as Left

**Description**

- Standard with: Fixed Top Shelf, Coat Rod, Three Adjustable/Removable Shelves
- Available in Premium Veneer (PV) or Standard Veneer (W); Must Specify
- Knob Pull will be Substituted for Finger Pull
- Optional Locking Door ([See Locking Options](#))

Must Specify (in this order):

- Model #
- Premium or Standard Veneer
- Finish/Color
- Edge Profile
- Pull
- Locking Door

|  |           |    |    |      |     |      |                  |
|--|-----------|----|----|------|-----|------|------------------|
| <b>DOUBLE WARDROBE/STORAGE CABINET</b> | 14-3670WD | 36 | 24 | 69¾" | 290 | 42.0 | W\$ 8716<br>PV\$ |
|--|-----------|----|----|------|-----|------|------------------|

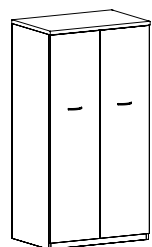

**Description**

- Standard with: Fixed Top Shelf Behind Each Door, Coat Rod, Three Adjustable/Removable Shelves on Each Side
- Available in Premium Veneer (PV) or Standard Veneer (W); Must Specify
- Knob Pull will be Substituted for Finger Pull
- Optional Locking Door ([See Locking Options](#))

Must Specify (in this order):

- Model #
- Premium or Standard Veneer
- Finish/Color
- Edge Profile
- Pull
- Locking Door

P = HPL W = Veneer PV = Premium Veneer

[See Madera Overview For Ordering Options](#)

| Item   | Model No.           | Width                | Depth | Height | Ship Wt | Cubic Ft | List Price |
|--|---------------------|----------------------|-------|--------|---------|----------|------------|
| DOUBLE WARDROBE/STORAGE CABINET WITH FILE/FILE | <b>Left Drawers</b> | <b>Right Drawers</b> |       |        |         |          |            |
|  | 14-3670WD2L         | 14-3670WD2R          | 36    | 24     | 69¾"    | 315      | 42.0       |

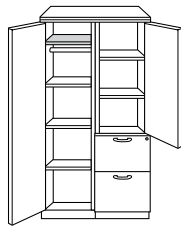

Shown as Right

**Description**

- One Side - Shaded Fixed Top Shelf, Coat Rod, and Three Adjustable Shelves
- One Side - Top Storage with Two Adjustable Shelves, Bottom Locking File/File
- Available in Premium Veneer (PV) or Standard Veneer (W); Must Specify
- Pedestal Determines Left or Right Handed Unit
- Finger Pull Not Available
- Optional Locking Door ([See Locking Options](#))

Must Specify (in this order):

Model #  
Premium or Standard Veneer  
Finish/Color  
Edge Profile  
Pull  
Locking Door

|   |                     |                      |    |    |      |     |      |
|---|---------------------|----------------------|----|----|------|-----|------|
| DOUBLE WARDROBE/STORAGE CABINET WITH BOX/BOX/FILE | <b>Left Drawers</b> | <b>Right Drawers</b> |    |    |      |     |      |
|   | 14-3670WD1L         | 14-3670WD1R          | 36 | 24 | 69¾" | 315 | 42.0 |



Shown as Right

**Description**

- One Side - Shaded Fixed Top Shelf, Coat Rod, and Three Adjustable Shelves
- One Side - Top Storage with Two Adjustable Shelves, Bottom Locking Box/Box/File
- Available in Premium Veneer (PV) or Standard Veneer (W); Must Specify
- Pedestal Determines Left or Right Handed Unit
- Finger Pull Not Available
- Optional Locking Door ([See Locking Options](#))

Must Specify (in this order):

Model #  
Premium or Standard Veneer  
Finish/Color  
Edge Profile  
Pull  
Locking Door

|   |            |    |    |      |     |      |                        |
|---|------------|----|----|------|-----|------|------------------------|
| STORAGE CABINET WITH LATERAL FILE DRAWERS | 14-3670SU2 | 36 | 24 | 69¾" | 298 | 42.0 | W\$ 9540<br>PV\$ 11162 |
|---|------------|----|----|------|-----|------|------------------------|

**Description**

- Standard with: Two 170° Hinged Doors, Two Adjustable Shelves on Top, Two Locking Lateral File Drawers on Bottom
- Lateral Drawers Provide Letter or Legal Filing Capabilities
- Available in Premium Veneer (PV) or Standard Veneer (W); Must Specify
- Finger Pull Not Available
- Optional Locking Door ([See Locking Options](#))

Must Specify (in this order):

Model #  
Premium or Standard Veneer  
Finish/Color  
Edge Profile  
Pull  
Locking Door

P = HPL W = Veneer PV = Premium Veneer

[See Madera Overview For Ordering Options](#)

Natta offers an agile solution for a variety of community spaces and meeting applications. With its simplicity of form, it can achieve a subtle effect and still provide an excellent solution for any meeting and breakout environment.

### CONSTRUCTION

*Natta Tables feature a wood base with HPL top.*

### TOPS

- High Pressure Laminate (HPL) tops are 3-ply balanced construction, 1½" thick with 1 mm PVC edge band and vertical square edge profile
- Grain direction runs left to right unless otherwise noted

### CHASSIS

- All frames are made of solid European Beech with double-doweled or mortised and tenoned joints
- Units are equipped with heavy-duty, adjustable glides to ensure proper leveling and compensation for uneven floors
- All table units ship fully assembled with tops installed

### HOW TO ORDER EXAMPLE

| Model No. | Description | Example |
|-----------|-------------|---------|
| NAT-1     | Top Color   | SBP     |
|           | Leg Finish  | SBP     |

### HPL (P) LAMINATE OPTIONS ON TOPS

#### WOODGRAIN

|     |                  |     |                     |
|-----|------------------|-----|---------------------|
| AS  | Asian Night      | PNW | Pinnacle Walnut     |
| BW  | Beigewood        | SCH | Select Cherry       |
| CO  | Columbian Walnut | SKC | Shaker Cherry       |
| EF  | Espresso         | SBP | Smoky Brown Pear    |
| GC  | Golden Cherry    | TK  | Studio Teak         |
| HVM | Harvest Maple    | SM  | Sugar Maple         |
| MW  | Mahogany Walnut  | WTA | Weathered Ash       |
| ORW | Oak Riftwood     | WC  | Williamsburg Cherry |

#### SOLID

WH Designer White

### TABLE EDGE PROFILE



Vertical  
Square

### WOOD FINISHES AVAILABLE ON BASE/LEGS

Indiana Furniture uses a multi-step, hand finishing process on all exposed wood frames.

Tables feature a catalyzed varnish finish which offers durability, lasting beauty, and resistance to normal wear.

|     |                     |     |                     |
|-----|---------------------|-----|---------------------|
| AW  | Artisan Walnut      | LW  | Legacy Walnut       |
| AS  | Asian Night         | MW  | Mahogany Walnut     |
| BW  | Beigewood*          | MO  | Medium Oak*         |
| BL  | Black               | ORW | Oak Riftwood*       |
| CO  | Columbian Walnut    | PNW | Pinnacle Walnut     |
| DC  | Dark Cherry         | SCH | Select Cherry       |
| DFW | Dark Forest Walnut* | SKC | Shaker Cherry       |
| WH  | Designer White      | SBP | Smoky Brown Pear*   |
| EF  | Espresso            | TK  | Studio Teak         |
| FO  | Fawn Oak*           | SM  | Sugar Maple         |
| GC  | Golden Cherry       | SW  | Sunglow Walnut      |
| HVM | Harvest Maple*      | WTA | Weathered Ash*      |
| HW  | Harvest Walnut      | WC  | Williamsburg Cherry |

\* Finish is Low Sheen

### CERTIFICATIONS & COMPLIANCE

- Intertek Sustainability Certified
- BIFMA level® Certified
- BIFMA Compliant Certified
- TSCA Title VI (Formerly CARB) Compliance
- US Green Building's LEED Contribution

### STATEMENT OF LINE

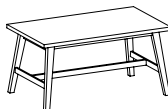

NAT-1: 30"H Table  
([See Details](#))



NAT-2: 42"H Table  
([See Details](#))

| Item               | Model No. | W   | D   | H   | Ship Wt | Cubic Ft | List Price |
|--------------------|-----------|-----|-----|-----|---------|----------|------------|
| 30"H MEETING TABLE | NAT-1     | 61½ | 35½ | 30½ | 106     | 43.7     | \$ 2293    |

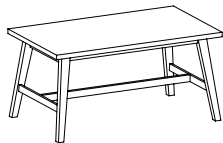

### Description

- Features Square Edge Profile
- Available with Contrasting Top and Leg Color

### Must Specify (in this order):

Model #  
Top Color  
Leg Finish

|                    |       |    |    |    |     |      |         |
|--------------------|-------|----|----|----|-----|------|---------|
| 42"H MEETING TABLE | NAT-2 | 63 | 39 | 43 | 115 | 64.0 | \$ 2836 |
|--------------------|-------|----|----|----|-----|------|---------|

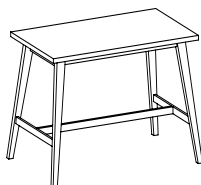

### Description

- Features Square Edge Profile
- Available in Contrasting Top and Leg Color

### Must Specify (in this order):

Model #  
Top Color  
Leg Finish

[See Natta Overview For Ordering Options](#)



One10 Conference provides a scalable aesthetic with a versatile range of tables that provide solutions for casual to formal meetings that can support individual technology, the sharing of personal technology, or communal technology equipment. From conference tables, meeting tables, TV stands, and Parsons Tables, the collection provides flexibility for tailored applications, virtually anywhere.

**CONSTRUCTION**

**VENEER**

- Exposed surfaces feature select grade plain-sliced hardwood veneers in Cherry, Maple, American Black Walnut, or composite veneers. Veneers are carefully selected and matched to assure proper balance and consistency
- Veneer features either our UVAdvantage, an ultra-violet finish, or our Catalyzed finish (where noted)

**LAMINATE**

- High-Pressure Laminates (HPL) are made of woodgrain and solid color laminates fused to particleboard core; each laminate offers lasting beauty, superior resistance to normal wear, and easy maintenance

**TOPS**

- Tops with the Block Edge are 1½" thick while tops with the Knife Edge are 1¾" thick
- Laminate tops offer 3-ply balanced construction with 1mm PVC edge-banded rims; Veneer tops offer 3-ply balanced construction with 1.5mm wood edge-banded rims
- Credenza tops are ¾" thick, 3-ply balanced construction with 0.5mm wood edge-banded rims on Veneer options and 1mm PVC edge-banded rims on Laminate options
- Veneer accent tops are ¾" thick, 3-ply construction with 0.5mm wood edge-banded rims while Laminate accent tops are ¾" thick, 3-ply construction with 1mm PVC edge-banded rims
- Grain direction runs left-to-right, unless noted
- The Block Edge profile will be used with Block Bases only, while the Knife Edge profile will be used with Blade Bases only



Block Edge Profile

Knife Edge Profile

**CHASSIS**

- Chassis for storage units are securely fastened using high quality European fastening systems and heavy-duty 16-gauge joining brackets to assure maximum strength
- Parsons Tables are formed with mitered construction to provide a clean aesthetic
- All units ship with heavy-duty, adjustable leveling glides to ensure proper leveling and compensation for uneven floors

**DRAWERS**

- All drawer fronts are ¾" thick, 3-ply construction with vertical grain direction
- Drawer sides, back, and front are woodgrain vinyl-wrapped ½" thick with ⅛" thick hardboard bottoms
- 5-sided drawer construction allows for easy removal of drawer fronts; All drawer fronts are standard with elegant vertically matched faces
- All drawers feature full extension, progressive action slides with precision steel ball bearings
- Box and file drawers are tested for 100lb capacity
- All suspensions have a limited lifetime warranty

**STORAGE**

- All hinged doors are soft-close, unless otherwise noted
- One piece hinge and base plate combination
- Soft close hinges reduce stress placed on the cabinet when the door is closed and offers a quiet closure

**HOW TO ORDER EXAMPLES**

**SMALL MEETING TABLES**

*Single Column Table*

|              | QTY | MODEL NO.    | DESCRIPTION                         | EXAMPLE  |
|--------------|-----|--------------|-------------------------------------|----------|
| <b>TOP</b>   | 1   | 95-6060SQV   | Finish/Color<br>Power/Data Location | FO<br>OC |
| <b>BASE</b>  | 1   | 95-3630BB    | Finish/Color                        | FO       |
| <b>POWER</b> | 1   | 01-DUOBEZELS |                                     |          |

**STANDARD MEETING TABLES**

*Rectangle Shaped with Center Inlay, Block Edge, and Block Bases*

|              | QTY | MODEL NO.    | DESCRIPTION                                 | EXAMPLE    |
|--------------|-----|--------------|---|------------|
| <b>TOP</b>   | 1   | 96-60192RTV5 | Primary Finish/Color<br>Accent Finish/Color | WTA<br>FHG |
| <b>BASES</b> | 2   | 96-2428BB    | Primary Finish/Color<br>Accent Finish/Color | WTA<br>FHG |
|              | 1   | 96-2428MSL   | Primary Finish/Color<br>Accent Finish/Color | WTA<br>FHG |
| <b>POWER</b> | 10  | 01-DUOS      |   |            |
|              | 2   | 01-TRIOS     |   |            |
|              | 2   | LCOMHDMI     |   |            |

**PARSONS TABLES**

*Parsons Table with Split Top*

|              | QTY | MODEL NO.   | DESCRIPTION                         | EXAMPLE    |
|--------------|-----|-------------|-------------------------------------|------------|
| <b>TABLE</b> | 1   | 95-4296TPST | Finish/Color<br>Power/Data Location | SBP<br>ELR |
| <b>POWER</b> | 2   | 01-TRIOB    |                                     |            |
|              | 2   | LCOMHDMI    |                                     |            |

**STORAGE & ACCESSORIES**

*Media Credenza*

|  | QTY | MODEL NO.  | DESCRIPTION  | EXAMPLE |
|--|-----|------------|--------------|---------|
|  | 1   | 95-1872OMC | Finish/Color | SBP     |

One10

**VENEER (W) OPTIONS ON TOPS, BASES, AND ACCENTS**

Veneer features UVAdvantage, an ultra-violet finish, on all exposed surfaces or our Catalyzed finish (where noted), which is a multi-step, finish process that provides years of lasting beauty.

|     |                    |     |                     |
|-----|--------------------|-----|---------------------|
| AW  | Artisan Walnut     | MW  | Mahogany Walnut     |
| AS  | Asian Night        | MO  | Medium Oak*         |
| CO  | Columbian Walnut   | ORW | Oak Riftwood*       |
| DC  | Dark Cherry        | SCH | Select Cherry       |
| DFW | Dark Forest Walnut | SKC | Shaker Cherry       |
| EW  | Espresso           | SBP | Smoky Brown Pear    |
| FO  | Fawn Oak*          | SM  | Sugar Maple         |
| GC  | Golden Cherry      | SW  | Sunglow Walnut      |
| HVM | Harvest Maple      | WTA | Weathered Ash*      |
| HW  | Harvest Walnut     | WC  | Williamsburg Cherry |
| LW  | Legacy Walnut      |     |                     |

\* Finish is Low Sheen

**HPL (P) LAMINATE OPTIONS ON TOPS, BASES, AND ACCENTS**

**WOODGRAIN**

|     |                  |     |                     |
|-----|------------------|-----|---------------------|
| AS  | Asian Night      | PNW | Pinnacle Walnut     |
| BW  | Beigewood        | SCH | Select Cherry       |
| CO  | Columbian Walnut | SKC | Shaker Cherry       |
| EF  | Espresso         | SBP | Smoky Brown Pear    |
| GC  | Golden Cherry    | TK  | Studio Teak         |
| HVM | Harvest Maple    | SM  | Sugar Maple         |
| MW  | Mahogany Walnut  | WTA | Weathered Ash       |
| ORW | Oak Riftwood     | WC  | Williamsburg Cherry |

**SOLID**

|     |                |     |             |
|-----|----------------|-----|-------------|
| BL  | Black*         | PPD | Pepperdust* |
| WH  | Designer White | SG  | Slate Grey* |
| FHG | Fashion Grey*  | WHS | White Sand* |

\* Available as Laminate Accent Only.

**POWER/DATA UNITS & LOCATIONS**

**Square & Round Shaped Tops with Blade Bases**

Models:

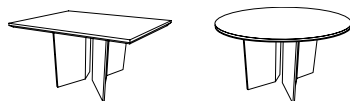

Modules Available (See Unit Details):

|               |  |
|---------------|--|
| 01-DUOBEZEL   | Available in Black (B), Silver (S), or White (W) |
| 01-TRIOBEZEL  | Available in Black (B), Silver (S), or White (W) |
| 01-PDUOBEZEL  | Available in Black (B), Silver (S), or White (W) |
| 01-PTRIOBEZEL | Available in Black (B), Silver (S), or White (W) |

Note: Only one Power/Data Module Per Top.

**Power/Data Location:**

- All Power/Data Modules will be placed **On Center (OC)** of top.
- Designate "OC" when specifying the top model. Power/Data Module will need to be ordered separately.
- Power/Data Modules specified at the time of order will be routed for field installation.

**Square & Rectangular Tops for Single and Dual Column Bases**

Models:

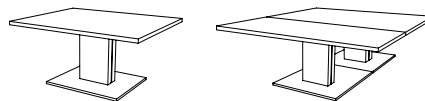

Modules Available (See Unit Details):

|              |  |
|--------------|--|
| 01-DUOBEZEL  | Available in Black (B), Silver (S), or White (W) |
| 01-TRIOBEZEL | Available in Black (B), Silver (S), or White (W) |

Note: Only one Power/Data Module Per Top. Must Order Two (2) Power/Data Modules for Dual Column Tables.

**Power/Data Location:**

- All Power/Data Modules will be placed **On Center (OC)** of each top and installed directly over the base.
- Designate "OC" when specifying the top model. Power/Data Module will need to be ordered separately.
- Power/Data Modules specified at the time of order will be routed for field installation.

**Rectangular 1 or 2 Piece Tops with Block or Blade Bases**

Models:

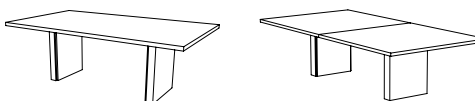

Modules Available (See Unit Details):

Available in Table Surface:

|               |  |
|---------------|--|
| 01-DUOBEZEL   | Available in Black (B), Silver (S), or White (W) |
| 01-TRIOBEZEL  | Available in Black (B), Silver (S), or White (W) |
| 01-PDUOBEZEL  | Available in Black (B), Silver (S), or White (W) |
| 01-PTRIOBEZEL | Available in Black (B), Silver (S), or White (W) |

Available Under Table Surface:

|          |  |
|----------|--|
| 01-DUO   | Available in Black (B), Silver (S), or White (W) |
| 01-TRIO  | Available in Black (B), Silver (S), or White (W) |
| 01-PDUO  | Available in Black (B), Silver (S), or White (W) |
| 01-PTRIO | Available in Black (B), Silver (S), or White (W) |

**Power/Data Location:**

- Power/Data Modules specified at the time of order will be routed for field installation.
- Modules to be mounted under the table surface may be placed anywhere during field installation - No need to specify location when ordering top.

|       |                                |
|-------|--------------------------------|
| E1    | 29" Off One End                |
| ELR   | 29" Off Each End               |
| OC    | On Center                      |
| OCELR | 29" Off Each End and On Center |

OCELR Not Available on Tables 96"W or Less

**Rectangular, Boat, and View Shaped Tops with Center Channel or Center Inlay**

**Modules Available** (See Unit Details):

- 01-DUO Available in Black (B), Silver (S), or White (W)
- 01-TRIO Available in Black (B), Silver (S), or White (W)

**Power/Data Location:**

- All troughs, included as standard with the tops, have pre-drilled peck-hole locations from the bottom side of the trough for easy field installation. No need to specify location when ordering top.
- Desired Power/Data Modules will need to be ordered separately.
- Field install Power/Data Modules by selecting any or all of the desired pre-marked locations and drill the hole through.

**Locations For: 48"x192" & 60"x192" Models with Center Channel/Inlay**

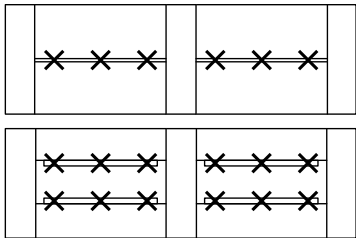

26½", 52", and 77½" off each end

31", 52", and 73" off each end

**Locations For: 48"x168" & 60"x168" Models with Center Channel/Inlay**

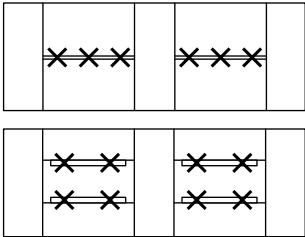

32½", 47½", and 62½" off each end

37" and 58" off each end

**Locations For: 48"x144" & 60"x144" Models with Center Channel/Inlay**

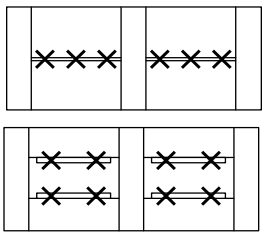

24½", 39½", and 54½" off each end

29" and 50" off each end

**Locations For: 48"x120" & 60"x120" Models with Center Channel/Inlay**



34½" and 60" off each end

39" and 60" off each end

**Locations For: 48"x108" & 60"x108" Models with Center Channel/Inlay**

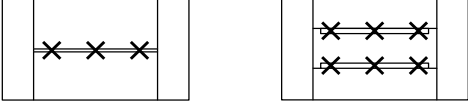

28½" and 54" off each end

33" and 54" off each end

**Locations For: 48"x96" & 60"x96" Models with Center Channel/Inlay**



33" and 48" off each end

37½" off each end

**Parsons Tables with Split Top**

**Models:**

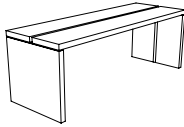

**Modules Available** (See Unit Details):

- 01-DUO Available in Black (B), Silver (S), or White (W)
- 01-TRIO Available in Black (B), Silver (S), or White (W)
- 01-PDUO Available in Black (B), Silver (S), or White (W)
- 01-PTRIO Available in Black (B), Silver (S), or White (W)

**Power/Data Location:**

- Power/Data Module will need to be ordered separately and per the quantity for the desired location needs listed below.
- Power/Data Modules specified at the time of order will be routed for field installation.

**Locations & Quantity For: 120" Parsons Tables with Split Top**

| QTY | CODE  | LOCATION                       |
|-----|-------|--------------------------------|
| 1   | OC    | On Center at 60"               |
| 2   | ELR   | 40" Off Each End               |
| 3   | OCELR | 30" Off Each End and On Center |

**Locations & Quantity For: 96" Parsons Tables with Split Top**

| QTY | CODE  | LOCATION                       |
|-----|-------|--------------------------------|
| 1   | OC    | On Center at 48"               |
| 2   | ELR   | 32" Off Each End               |
| 3   | OCELR | 24" Off Each End and On Center |

**Locations & Quantity For: 72" Parsons Tables with Split Top**

| QTY | CODE  | LOCATION                       |
|-----|-------|--------------------------------|
| 1   | OC    | On Center at 36"               |
| 2   | ELR   | 24" Off Each End               |
| 3   | OCELR | 18" Off Each End and On Center |

**CERTIFICATIONS & SUSTAINABILITY**

- Intertek Sustainability Certified
- BIFMA level® Certified
- BIFMA Compliant® Certified
- TSCA Title VI (formerly CARB) Compliance
- US Green Building's LEED® Contribution

### Small Meeting Tables

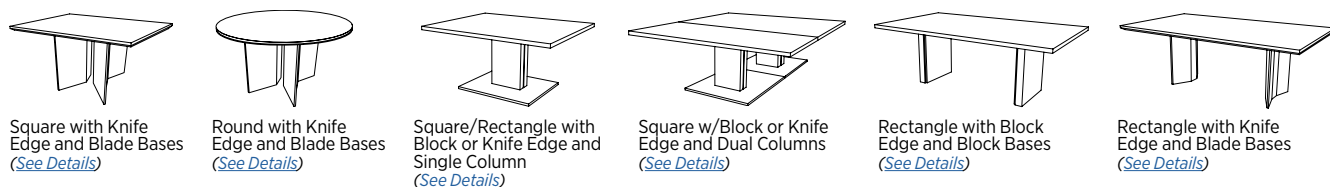

### Standard Meeting Tables

Select from a variety of tops featuring solid, channels, or inlays in your choice of Block or Knife Edge

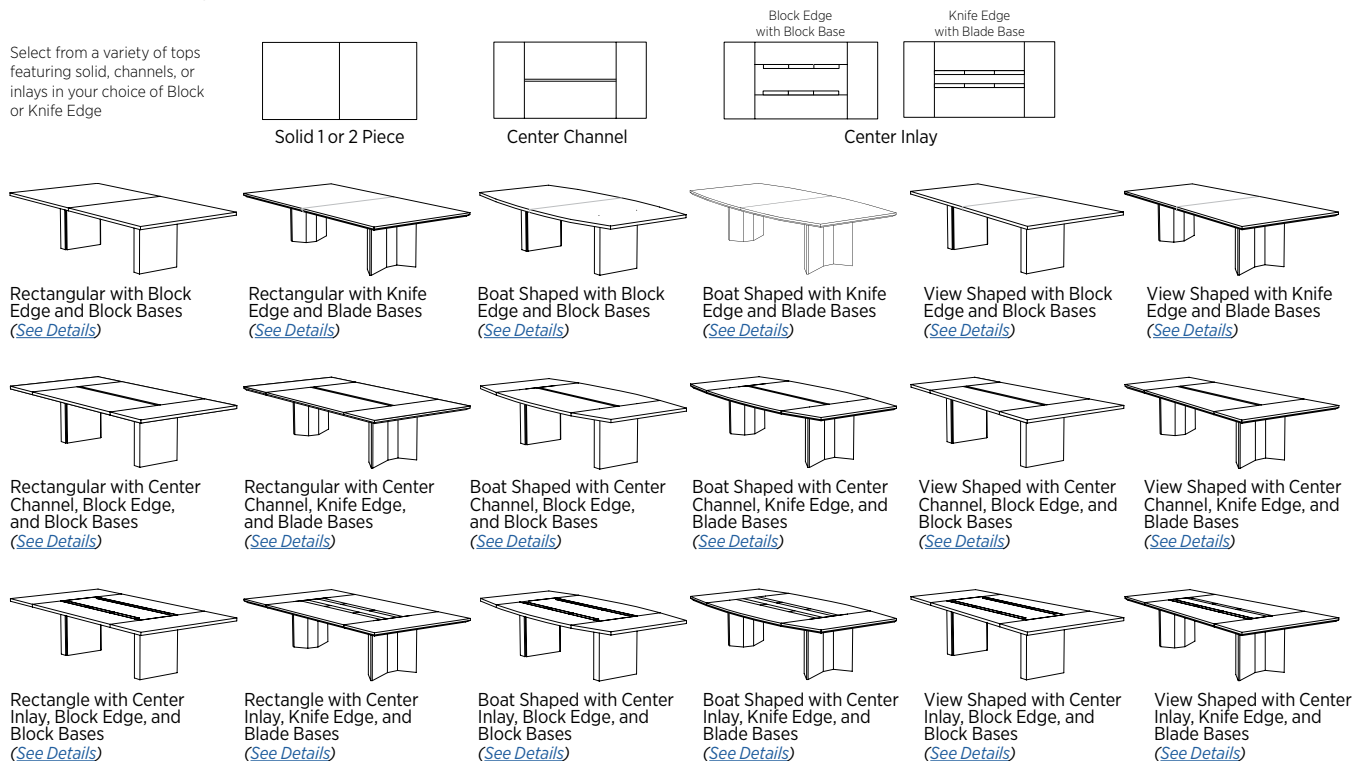

### Parsons Tables

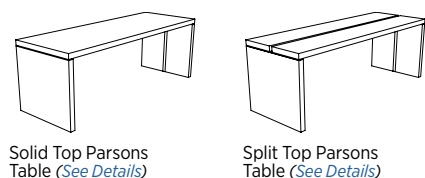

### Wire Management & Power/Data Accessories ([See Multiple Unit Details](#))

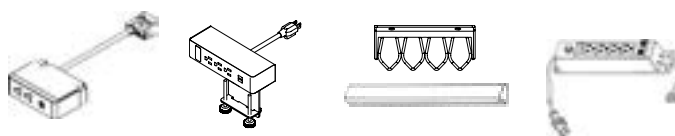

### Storage & Accessories

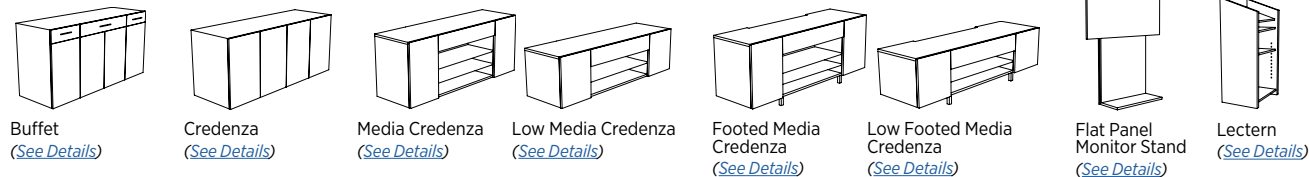

| Item                                       | Model No.  |        | W  | D  | H  | Ship Wt | Cubic Ft | List Price |
|--|------------|--------|----|----|----|---------|----------|------------|
| SMALL MEETING TABLES                       | 96-6060SQK | HPL    | 60 | 60 | 1¾ | 143     | 8.4      | P\$ 2191   |
|  | 95-6060SQK | Veneer |    |    |    |         |          | W\$ 3139   |
| SQUARE TOP<br>BLADE BASE SET<br>KNIFE EDGE | 96-5454SQK | HPL    | 54 | 54 | 1¾ | 114     | 6.8      | P\$ 2009   |
|  | 95-5454SQK | Veneer |    |    |    |         |          | W\$ 2878   |
|  | 96-4848SQK | HPL    | 48 | 48 | 1¾ | 90      | 5.5      | P\$ 1741   |
|  | 95-4848SQK | Veneer |    |    |    |         |          | W\$ 2572   |



Must Specify (in this order):

- Model #
- Finish/Color
- Power/Data Location

Description

- Veneer Tops Feature UV Finish on 48"D and Catalyzed Finish on 54"D and 60"D
- Requires One (1) Blade Base Set; Sold Separately, See Below
- Outer Panel can be Specified in a Contrasting Finish/Color from Top Finish/Color
- Power and Data Options Available; Sold Separately, [See Multiple Power Unit Details](#); Unit Will Be Routed On Center. [See Location Details](#)

BLADE BASE SET

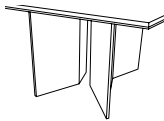

Must Specify (in this order):

- Model #
- Finish/Color

| Blade Base Set with Stretchers - Requires One (1) Set |        |  |    |     |    |    |     |          |
|---|--------|--|----|-----|----|----|-----|----------|
| 96-2711BL   | HPL    |  | 27 | 10½ | 28 | 45 | 1.9 | P\$ 3788 |
| 95-2711BL   | Veneer |  |    |     |    |    |     | W\$ 4765 |

| Item                                      | Model No.  |        | W  | D  | H  | Ship Wt | Cubic Ft | List Price |
|---|------------|--------|----|----|----|---------|----------|------------|
| SMALL MEETING TABLES                      | 96-6060CTK | HPL    | 60 | 60 | 1¾ | 143     | 8.4      | P\$ 2195   |
|   | 95-6060CTK | Veneer |    |    |    |         |          | W\$ 3197   |
| ROUND TOP<br>BLADE BASE SET<br>KNIFE EDGE | 96-5454CTK | HPL    | 54 | 54 | 1¾ | 114     | 6.8      | P\$ 2016   |
|   | 95-5454CTK | Veneer |    |    |    |         |          | W\$ 2939   |
|   | 96-4848CTK | HPL    | 48 | 48 | 1¾ | 90      | 5.5      | P\$ 1754   |
|   | 95-4848CTK | Veneer |    |    |    |         |          | W\$ 2623   |



Must Specify (in this order):

- Model #
- Finish/Color
- Power/Data Location

Description

- Veneer Tops Feature UV Finish on 48"D and Catalyzed Finish on 54"D and 60"D
- Requires One (1) Blade Base Set; Sold Separately, See Below
- Outer Panel can be Specified in a Contrasting Finish/Color from Top Finish/Color
- Power and Data Options Available; Sold Separately, [See Multiple Power Unit Details](#); Unit Will Be Routed On Center. [See Location Details](#)

BLADE BASE SET

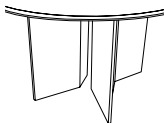

Must Specify (in this order):

- Model #
- Finish/Color

| Blade Base Set with Stretchers |        |  |    |     |    |    |     |          |
|--------------------------------|--------|--|----|-----|----|----|-----|----------|
| 96-2711BL                      | HPL    |  | 27 | 10½ | 28 | 45 | 1.9 | P\$ 3788 |
| 95-2711BL                      | Veneer |  |    |     |    |    |     | W\$ 4765 |

P = HPL W = Veneer

[See One10 Overview For Ordering Options](#)

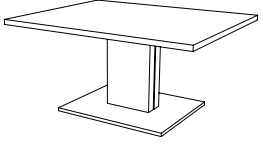
| Item  | Model No.               |        | W  | D  | H   | Ship Wt | Cubic Ft | List Price |  |
|---|-------------------------|--------|----|----|-----|---------|----------|------------|--|
| <b>SMALL MEETING TABLES</b>   |                         |        |    |    |     |         |          |            |  |
| <b>Block Edge</b>   |                         |        |    |    |     |         |          |            |  |
| <i>Square Tops</i>  |                         |        |    |    |     |         |          |            |  |
| <b>SQUARE/RECTANGULAR<br/>1 PIECE TOP<br/>SEATING OR STANDING HEIGHT<br/>SINGLE COLUMN BASE<br/>BLOCK OR KNIFE EDGE</b>  | 96-6060SQV              | HPL    | 60 | 60 | 1½  | 143     | 8.4      | P\$ 1880   |  |
|   | 95-6060SQV              | Veneer |    |    |     |         |          | W\$ 2503   |  |
|   | 96-5454SQV              | HPL    | 54 | 54 | 1½  | 114     | 6.8      | P\$ 1725   |  |
|   | 95-5454SQV              | Veneer |    |    |     |         |          | W\$ 2233   |  |
|   | 96-4848SQV              | HPL    | 48 | 48 | 1½  | 90      | 5.5      | P\$ 1498   |  |
|   | 95-4848SQV              | Veneer |    |    |     |         |          | W\$ 1864   |  |
|   | <i>Rectangular Tops</i> |        |    |    |     |         |          |            |  |
|   | 96-4896RTVBB            | HPL    | 48 | 96 | 1½  | 205     | 17.7     | P\$ 1895   |  |
|   | 95-4896RTVBB            | Veneer |    |    |     |         |          | W\$ 2600   |  |
|   | 96-4884RTV              | HPL    | 48 | 84 | 1½  | 158     | 9.3      | P\$ 1839   |  |
| 95-4884RTV  | Veneer                  |        |    |    |     |         | W\$ 2337 |            |  |
| 96-4872RTV  | HPL                     | 48     | 72 | 1½ | 135 | 8.1     | P\$ 1753 |            |  |
| 95-4872RTV  | Veneer                  |        |    |    |     |         | W\$ 2083 |            |  |
| 96-4860RTV  | HPL                     | 48     | 60 | 1½ | 112 | 6.8     | P\$ 1669 |            |  |
| 95-4860RTV  | Veneer                  |        |    |    |     |         | W\$ 1860 |            |  |
| <b>Knife Edge</b>   |                         |        |    |    |     |         |          |            |  |
| <i>Square Tops</i>  |                         |        |    |    |     |         |          |            |  |
| 96-6060SQK  | HPL                     | 60     | 60 | 1⅜ | 143 | 8.4     | P\$ 2191 |            |  |
| 95-6060SQK  | Veneer                  |        |    |    |     |         | W\$ 3139 |            |  |
| 96-5454SQK  | HPL                     | 54     | 54 | 1⅜ | 114 | 6.8     | P\$ 2009 |            |  |
| 95-5454SQK  | Veneer                  |        |    |    |     |         | W\$ 2878 |            |  |
| 96-4848SQK  | HPL                     | 48     | 48 | 1⅜ | 90  | 5.5     | P\$ 1741 |            |  |
| 95-4848SQK  | Veneer                  |        |    |    |     |         | W\$ 2572 |            |  |
| <i>Rectangular Tops</i>   |                         |        |    |    |     |         |          |            |  |
| 96-4896RTKBB  | HPL                     | 48     | 96 | 1⅜ | 180 | 11.4    | P\$ 2241 |            |  |
| 95-4896RTKBB  | Veneer                  |        |    |    |     |         | W\$ 3078 |            |  |
| 96-4884RTKBB  | HPL                     | 48     | 84 | 1⅜ | 158 | 10.0    | P\$ 2173 |            |  |
| 95-4884RTKBB  | Veneer                  |        |    |    |     |         | W\$ 2732 |            |  |
| 96-4872RTKBB  | HPL                     | 48     | 72 | 1⅜ | 135 | 8.1     | P\$ 2071 |            |  |
| 95-4872RTKBB  | Veneer                  |        |    |    |     |         | W\$ 2435 |            |  |
| 96-4860RTKBB  | HPL                     | 48     | 60 | 1⅜ | 112 | 6.8     | P\$ 1980 |            |  |
| 95-4860RTKBB  | Veneer                  |        |    |    |     |         | W\$ 2188 |            |  |

Must Specify (in this order):

- Model #
- Finish/Color
- Power/Data Location

**Description**

- All Models Feature a 1-piece, 1⅜" Thick Top
- Veneer Tops Feature UV Finish on 48"D and Catalyzed Finish on 54"D and 60"D
- Metal Frame Column Bases For Seated Height or Standing Height Tables; Sold Separately, See Below
- Power and Data Options Available; Sold Separately, [See Multiple Power Unit Details](#); Unit Will Be Routed On Center. [See Location Details](#)

**METAL FRAME COLUMN BASES**

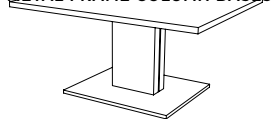

| <b>Bases for Tables ≤72"D</b> |                     |  |    |    |    |     |      |          |
|-------------------------------|---------------------|--|----|----|----|-----|------|----------|
| 96-3630TBB                    | 42" Standing Height |  | 36 | 30 | 40 | 178 | 30.4 | P\$ 2821 |
| 95-3630TBB                    |                     |  |    |    |    |     |      | W\$ 3308 |
| 96-3630BB                     | 30" Seated Height   |  | 36 | 30 | 28 | 168 | 26.2 | P\$ 2671 |
| 95-3630BB                     |                     |  |    |    |    |     |      | W\$ 2943 |
| <b>Bases for Tables ≥84"D</b> |                     |  |    |    |    |     |      |          |
| 96-6030TBB                    | 42" Standing Height |  | 60 | 30 | 40 | 257 | 49.5 | P\$ 3666 |
| 95-6030TBB                    |                     |  |    |    |    |     |      | W\$ 4111 |
| 96-6030BB                     | 30" Seated Height   |  | 60 | 30 | 28 | 211 | 35.7 | P\$ 3540 |
| 95-6030BB                     |                     |  |    |    |    |     |      | W\$ 3809 |

**Description**

- Aluminum Base Platform and Aluminum Detail Continues Up the Column for Design Appeal
- Column Accommodates Wire Management with Removable Panel for Power and Data
- Adjustable Levelers

P = HPL W = Veneer

[See One10 Overview For Ordering Options](#)

| Item   | Model No.                       |        | W  | D  | H  | Ship Wt | Cubic Ft | List Price |  |
|--|---------------------------------|--------|----|----|----|---------|----------|------------|--|
| <b>SMALL MEETING TABLES</b>  |                                 |        |    |    |    |         |          |            |  |
| <b>Block Edge - 2 Piece Top</b>  |                                 |        |    |    |    |         |          |            |  |
| <b>SQUARE SHAPED<br/>2 PIECE TOP<br/>SEATING OR STANDING HEIGHT<br/>DUAL COLUMN BASE<br/>BLOCK OR KNIFE EDGE</b> | 96-9696SQV                      | HPL    | 96 | 96 | 1½ | 379     | 21.2     | P\$ 4579   |  |
|  | 95-9696SQV                      | Veneer |    |    |    |         |          | W\$ 4752   |  |
|  | 96-8484SQV                      | HPL    | 84 | 84 | 1½ | 294     | 21.2     | P\$ 4216   |  |
|  | 95-8484SQV                      | Veneer |    |    |    |         |          | W\$ 4375   |  |
|  | <b>Knife Edge - 2 Piece Top</b> |        |    |    |    |         |          |            |  |
|  | 96-9696SQK                      | HPL    | 96 | 96 | 1⅝ | 287     | 21.2     | P\$ 4752   |  |
|  | 95-9696SQK                      | Veneer |    |    |    |         |          | W\$ 6277   |  |
|  | 96-8484SQK                      | HPL    | 84 | 84 | 1⅝ | 224     | 21.2     | P\$ 4375   |  |
| 95-8484SQK   | Veneer                          |        |    |    |    |         | W\$ 5741 |            |  |

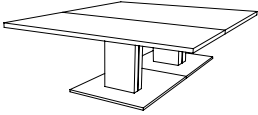

Must Specify (in this order):  
Model #  
Finish/Color  
Power/Data Location

**Description**

- All Models Feature a 2-piece, 1½" Thick Top
- Veneer Tops Feature Catalyzed Finish
- Requires Two (2) Metal Frame Column Bases For Seated Height or Standing Height Tables; Sold Separately, See Below
- Power and Data Options Available; Sold Separately, [See Multiple Power Unit Details](#); If Ordering, Must Order Two (2) as Units Will Be Routed On Center of Each Top, Directly Above the Bases. [See Location Details](#)

**METAL FRAME COLUMN BASES**

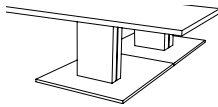

| <b>Two (2) Bases Required</b> |                     |    |    |    |     |      |  |          |
|-------------------------------|---------------------|----|----|----|-----|------|--|----------|
| 96-6030TBB                    | 42" Standing Height | 60 | 30 | 40 | 257 | 49.5 |  | P\$ 3666 |
| 95-6030TBB                    |                     |    |    |    |     |      |  | W\$ 4111 |
| 96-6030BB                     | 30" Seated Height   | 60 | 30 | 28 | 211 | 35.7 |  | P\$ 3540 |
| 95-6030BB                     |                     |    |    |    |     |      |  | W\$ 3809 |

**Description**

- Two (2) Bases Required
- Aluminum Base Platform and Aluminum Detail Continues Up the Column for Design Appeal
- Column Accommodates Wire Management with Removable Panel for Power and Data
- Adjustable Levelers

Must Specify (in this order):  
Model #  
Finish/Color

P = HPL W = Veneer

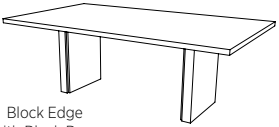
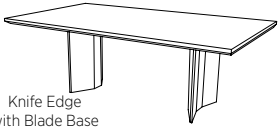
| Item   | Model No.  |        | W  | D  | H  | Ship Wt | Cubic Ft | List Price |
|--|------------|--------|----|----|----|---------|----------|------------|
| <b>SMALL MEETING TABLES</b>  |            |        |    |    |    |         |          |            |
| <b>Block Edge (Use with Block Base Only)</b>   |            |        |    |    |    |         |          |            |
| <i>48"W Tops</i>   |            |        |    |    |    |         |          |            |
| <b>RECTANGULAR SHAPE</b><br><b>1 PIECE TOP</b><br><b>BLOCK EDGE W/BLOCK BASE</b><br><b>OR KNIFE EDGE W/BLADE BASE</b>  | 96-4884RTV | HPL    | 48 | 84 | 1½ | 158     | 9.3      | P\$ 1839   |
|  | 95-4884RTV | Veneer |    |    |    |         |          | W\$ 2337   |
|  | 96-4872RTV | HPL    | 48 | 72 | 1½ | 135     | 8.1      | P\$ 1753   |
|  | 95-4872RTV | Veneer |    |    |    |         |          | W\$ 2083   |
| <i>42"W Tops</i>   |            |        |    |    |    |         |          |            |
|  <p>Block Edge<br/>with Block Base</p>  <p>Knife Edge<br/>with Blade Base</p> | 96-4296RTV | HPL    | 42 | 96 | 1½ | 158     | 9.1      | P\$ 1753   |
|  | 95-4296RTV | Veneer |    |    |    |         |          | W\$ 2444   |
|  | 96-4284RTV | HPL    | 42 | 84 | 1½ | 138     | 8.1      | P\$ 1680   |
|  | 95-4284RTV | Veneer |    |    |    |         |          | W\$ 2307   |
|  | 96-4272RTV | HPL    | 42 | 72 | 1½ | 119     | 7.1      | P\$ 1603   |
|  | 95-4272RTV | Veneer |    |    |    |         |          | W\$ 1879   |
| <i>36"W Tops</i>   |            |        |    |    |    |         |          |            |
|  | 96-3696RTV | HPL    | 36 | 96 | 1½ | 135     | 8.1      | P\$ 1684   |
|  | 95-3696RTV | Veneer |    |    |    |         |          | W\$ 2246   |
|  | 96-3684RTV | HPL    | 36 | 84 | 1½ | 119     | 7.1      | P\$ 1619   |
|  | 95-3684RTV | Veneer |    |    |    |         |          | W\$ 1962   |
|  | 96-3672RTV | HPL    | 36 | 72 | 1½ | 102     | 6.2      | P\$ 1579   |
|  | 95-3672RTV | Veneer |    |    |    |         |          | W\$ 1781   |
| <b>Knife Edge (Use with Blade Base Only)</b>   |            |        |    |    |    |         |          |            |
| <i>48"W Tops</i>   |            |        |    |    |    |         |          |            |
|  | 96-4884RTK | HPL    | 48 | 84 | 1⅝ | 158     | 9.3      | P\$ 4006   |
|  | 95-4884RTK | Veneer |    |    |    |         |          | W\$ 5209   |
|  | 96-4872RTK | HPL    | 48 | 72 | 1⅝ | 135     | 8.1      | P\$ 3796   |
|  | 95-4872RTK | Veneer |    |    |    |         |          | W\$ 4649   |
| <i>42"W Tops</i>   |            |        |    |    |    |         |          |            |
|  | 96-4296RTK | HPL    | 42 | 96 | 1⅝ | 158     | 9.1      | P\$ 4259   |
|  | 95-4296RTK | Veneer |    |    |    |         |          | W\$ 5427   |
|  | 96-4284RTK | HPL    | 42 | 84 | 1⅝ | 138     | 8.1      | P\$ 3840   |
|  | 95-4284RTK | Veneer |    |    |    |         |          | W\$ 4953   |
|  | 96-4272RTK | HPL    | 42 | 72 | 1⅝ | 119     | 7.1      | P\$ 3635   |
|  | 95-4272RTK | Veneer |    |    |    |         |          | W\$ 4605   |
| <i>36"W Tops</i>   |            |        |    |    |    |         |          |            |
|  | 96-3696RTK | HPL    | 36 | 96 | 1⅝ | 135     | 8.1      | P\$ 4117   |
|  | 95-3696RTK | Veneer |    |    |    |         |          | W\$ 5330   |
|  | 96-3684RTK | HPL    | 36 | 84 | 1⅝ | 119     | 7.1      | P\$ 3743   |
|  | 95-3684RTK | Veneer |    |    |    |         |          | W\$ 4779   |
|  | 96-3672RTK | HPL    | 36 | 72 | 1⅝ | 102     | 6.2      | P\$ 3555   |
|  | 95-3672RTK | Veneer |    |    |    |         |          | W\$ 4494   |

Must Specify (in this order):

- Model #
- Finish/Color
- Power/Data Location

*Continued on next page.*

P = HPL W = Veneer C = Combination of Wood/Laminate

[See One10 Overview For Ordering Options](#)



| Item | Model No. | W | D | H | Ship Wt | Cubic Ft | List Price |
|------|-----------|---|---|---|---------|----------|------------|
|------|-----------|---|---|---|---------|----------|------------|

Continued from  
Previous Page

**What You Get:**

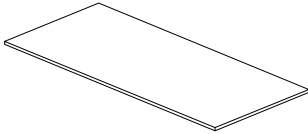

Top

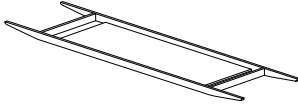

Trough  
(on Knife Edge with Blade Bases Only)

**Description**

- 1½" Thick Rectangular Top with Block Edge or 1¾" Thick Rectangular Top with Knife Edge
- All Models Feature a 1 Piece Top
- Veneer Tops Feature Catalyzed Finish
- Requires Two (2) Block Bases (Block Edge Only) or Blade Bases (Knife Edge Only); Sold Separately, See Below
- Block Bases Require Stretcher Rails; Sold Separately, See Below
- Blade Bases come with Trough to Reinforce and Support Top
- Power and Data Options Available; Sold Separately, [See Multiple Power Unit Details](#); [See Location Options](#)
- Assembly Required

**Top Grain Direction**

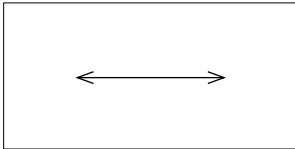

**BASES & STRETCHERS**

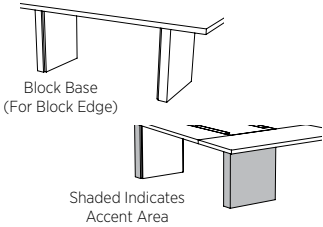

Block Base  
(For Block Edge)

Shaded Indicates  
Accent Area

**Must Specify (in this order):**

- Standard Base Model #
- Stretchers (If needed)
- Primary Finish/Color
- Accent Material
- Accent Finish/Color

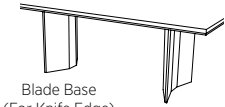

Blade Base  
(For Knife Edge)

**Must Specify (in this order):**

- Standard Base Model #
- Stretchers (If needed)
- Primary Finish/Color

| Block Bases; Must Order - Two (2) Required                        |            |     |     |    |     |     |     |      |
|---|------------|-----|-----|----|-----|-----|-----|------|
| 96-2228BB   | HPL        | 22  | 5¼  | 28 | 45  | 1.9 | P\$ | 1393 |
| 95-2228BB   | Veneer     |     |     |    |     |     | W\$ | 1913 |
| 95-2228BB   | Veneer/HPL |     |     |    |     |     | C\$ | 2169 |
| Stretcher Sets For Block Bases; Must Order - One (1) Set Required |            |     |     |    |     |     |     |      |
| <i>For 96"D Tables</i>  |            |     |     |    |     |     |     |      |
| 96-0496STR  | HPL        | 54¾ | ¾   | 4⅝ | 9.2 | 0.5 | P\$ | 676  |
| 95-0496STR  | Veneer     |     |     |    |     |     | W\$ | 812  |
| <i>For 84"D Tables</i>  |            |     |     |    |     |     |     |      |
| 96-0484STR  | HPL        | 42¾ | ¾   | 4⅝ | 7.2 | 0.4 | P\$ | 602  |
| 95-0484STR  | Veneer     |     |     |    |     |     | W\$ | 720  |
| <i>For 72"D Tables</i>  |            |     |     |    |     |     |     |      |
| 96-0472STR  | HPL        | 30¾ | ¾   | 4⅝ | 5.2 | 0.3 | P\$ | 560  |
| 95-0472STR  | Veneer     |     |     |    |     |     | W\$ | 654  |
| Blade Bases; Must Order - Two (2) Required                        |            |     |     |    |     |     |     |      |
| 96-2828BD   | HPL        | 28  | 10½ | 28 | 52  | 2.4 | P\$ | 1210 |
| 95-2828BD   | Veneer     |     |     |    |     |     | W\$ | 1666 |

**Description**

- All Tables with a Block Edge Require Two (2) Block Bases and One (1) Set of Stretchers; All Tables with a Knife Edge Require Two (2) Blade Bases
- Bases are Constructed with Removable Interior Panel for Wire Management Installation
- Outer Panel can be Specified in a Contrasting Finish/Color from Top Finish/Color
- Adjustable Glides Included

P = HPL W = Veneer C = Combination of Wood/Laminate

[See One10 Overview For Ordering Options](#)

| Item   | Model No.                 |                           | W   | D  | H   | Ship Wt | Cubic Ft | List Price |  |
|--|---------------------------|---------------------------|-----|----|-----|---------|----------|------------|--|
| <b>STANDARD TABLES</b>   |                           | <b>60"D Tops</b>          |     |    |     |         |          |            |  |
|  |                           | <i>192"W: 2 Piece Top</i> |     |    |     |         |          |            |  |
| <b>RECTANGULAR SHAPE</b><br><b>1 OR 2 PIECE TOP</b><br><b>BLOCK EDGE</b><br><b>BLOCK BASE</b>  | 96-60192RTV               | HPL                       | 192 | 60 | 1½  | 482     | 28.2     | P\$ 8696   |  |
|  | 95-60192RTV               | Veneer                    |     |    |     |         |          | W\$ 9428   |  |
|  | <i>168"W: 2 Piece Top</i> |                           |     |    |     |         |          |            |  |
|  | 96-60168RTV               | HPL                       | 168 | 60 | 1½  | 449     | 24.8     | P\$ 8093   |  |
|  | 95-60168RTV               | Veneer                    |     |    |     |         |          | W\$ 8729   |  |
|  | <i>144"W: 2 Piece Top</i> |                           |     |    |     |         |          |            |  |
|  | 96-60144RTV               | HPL                       | 144 | 60 | 1½  | 388     | 21.4     | P\$ 6773   |  |
|  | 95-60144RTV               | Veneer                    |     |    |     |         |          | W\$ 8139   |  |
|  | <i>120"W: 2 Piece Top</i> |                           |     |    |     |         |          |            |  |
|  | 96-60120RTV               | HPL                       | 120 | 60 | 1½  | 332     | 18.0     | P\$ 5706   |  |
|  | 95-60120RTV               | Veneer                    |     |    |     |         |          | W\$ 6721   |  |
|  | <i>108"W: 1 Piece Top</i> |                           |     |    |     |         |          |            |  |
| 96-60108RTV  | HPL                       | 108                       | 60  | 1½ | 301 | 16.3    | P\$ 4990 |            |  |
| 95-60108RTV  | Veneer                    |                           |     |    |     |         | W\$ 6638 |            |  |
| <i>96"W: 1 Piece Top</i>   |                           |                           |     |    |     |         |          |            |  |
| 96-6096RTV   | HPL                       | 96                        | 60  | 1½ | 262 | 14.6    | P\$ 4623 |            |  |
| 95-6096RTV   | Veneer                    |                           |     |    |     |         | W\$ 5524 |            |  |
|  |                           | <b>48"D Tops</b>          |     |    |     |         |          |            |  |
|  |                           | <i>192"W: 2 Piece Top</i> |     |    |     |         |          |            |  |
| <p>Must Specify (in this order):</p> <ul style="list-style-type: none"> <li>Model #</li> <li>Finish/Color</li> <li>Power/Data Location</li> </ul> <p>Rectangular 1 or 2-Piece Top available with a Knife Edge and coordinating Blade Base.</p> <p><a href="#">See Details.</a></p> | 96-48192RTV               | HPL                       | 192 | 48 | 1½  | 426     | 22.7     | P\$ 7331   |  |
|  | 95-48192RTV               | Veneer                    |     |    |     |         |          | W\$ 8516   |  |
|  | <i>168"W: 2 Piece Top</i> |                           |     |    |     |         |          |            |  |
|  | 96-48168RTV               | HPL                       | 168 | 48 | 1½  | 368     | 19.9     | P\$ 6967   |  |
|  | 95-48168RTV               | Veneer                    |     |    |     |         |          | W\$ 7994   |  |
|  | <i>144"W: 2 Piece Top</i> |                           |     |    |     |         |          |            |  |
|  | 96-48144RTV               | HPL                       | 144 | 48 | 1½  | 318     | 17.1     | P\$ 5730   |  |
|  | 95-48144RTV               | Veneer                    |     |    |     |         |          | W\$ 7403   |  |
|  | <i>120"W: 2 Piece Top</i> |                           |     |    |     |         |          |            |  |
|  | 96-48120RTV               | HPL                       | 120 | 48 | 1½  | 269     | 14.3     | P\$ 4940   |  |
|  | 95-48120RTV               | Veneer                    |     |    |     |         |          | W\$ 5811   |  |
|  | <i>108"W: 1 Piece Top</i> |                           |     |    |     |         |          |            |  |
| 96-48108RTV  | HPL                       | 108                       | 48  | 1½ | 234 | 12.9    | P\$ 4605 |            |  |
| 95-48108RTV  | Veneer                    |                           |     |    |     |         | W\$ 5554 |            |  |
| <i>96"W: 1 Piece Top</i>   |                           |                           |     |    |     |         |          |            |  |
| 96-4896RTV   | HPL                       | 96                        | 48  | 1½ | 205 | 11.5    | P\$ 3611 |            |  |
| 95-4896RTV   | Veneer                    |                           |     |    |     |         | W\$ 4807 |            |  |

*Continued on next page.*

P = HPL W = Veneer

[See One10 Overview For Ordering Options](#)

| Item | Model No. | W | D | H | Ship Wt | Cubic Ft | List Price |
|------|-----------|---|---|---|---------|----------|------------|
|------|-----------|---|---|---|---------|----------|------------|

Continued from  
Previous Page

**What You Get:**

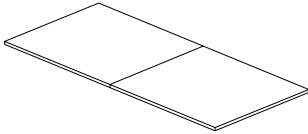

Top

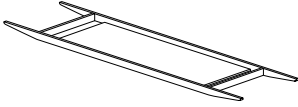

Trough

**Description**

- 1½" Thick Rectangular Top with Block Edge
- Veneer Tops Feature UV Finish on 48"D and Catalyzed Finish on 60"D
- Trough Reinforces and Supports Top
- Requires Two (2) Block Bases; Tables 144"W or Larger Also Require Middle Block Base; Sold Separately, See Below
- Power and Data Options Available; Sold Separately, [See Multiple Power Unit Details](#); [See Location Options](#)
- Assembly Required

**Top Grain Direction**

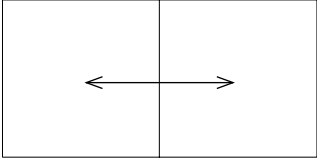

**BLOCK BASES**

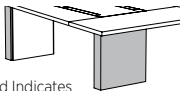
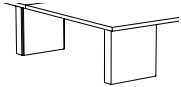

Shaded Indicates  
Accent Area

| <b>Block Base Options; Must Order</b>                        |            |    |    |    |    |     |          |
|--|------------|----|----|----|----|-----|----------|
| <i>Standard Block Base - Two (2) Required</i>                |            |    |    |    |    |     |          |
| 96-2428BB  | HPL        | 24 | 6  | 28 | 52 | 2.4 | P\$ 1483 |
| 95-2428BB  | Veneer     |    |    |    |    |     | W\$ 2036 |
| 95-2428BB  | Veneer/HPL |    |    |    |    |     | C\$ 2280 |
| <i>Middle Block Base - Required for Tops 144"W or Larger</i> |            |    |    |    |    |     |          |
| 96-2428MSL   | HPL        | 24 | 7½ | 28 | 72 | 2.8 | P\$ 1811 |
| 95-2428MSL   | Veneer     |    |    |    |    |     | W\$ 2355 |
| 95-2428MSL   | Veneer/HPL |    |    |    |    |     | C\$ 2682 |

**Description**



- All Tops Require Two (2) Block Bases; Tables 144"W or Larger Also Require Middle Block Base
- Bases are Constructed with Removable Interior Panel for Wire Management Installation
- Outer Panel can be Specified in a Contrasting Finish/Color from Top Finish/Color
- Adjustable Glides Included

Must Specify (in this order):

- Standard Base Model #
- Primary Finish/Color
- Accent Material
- Accent Finish/Color
- Middle Base Model # (If needed)
- Middle Base Primary Finish/Color
- Middle Base Accent Material
- Middle Base Accent Finish/Color

P = HPL W = Veneer C = Combination of Wood/Laminate

[See One10 Overview For Ordering Options](#)

| Item   | Model No.   |                           | W   | D  | H      | Ship Wt | Cubic Ft | List Price |  |
|--|-------------|---------------------------|-----|----|--------|---------|----------|------------|--|
| <b>STANDARD TABLES</b>   |             | <b>60"D Tops</b>          |     |    |        |         |          |            |  |
|  |             | <i>192"W: 2 Piece Top</i> |     |    |        |         |          |            |  |
| RECTANGULAR SHAPE<br>1 OR 2 PIECE TOP<br>KNIFE EDGE<br>BLADE BASE                              | 96-60192RTK | HPL                       | 192 | 60 | 1 3/16 | 482     | 28.2     | P\$ 9743   |  |
|  | 95-60192RTK | Veneer                    |     |    |        |         |          | W\$ 10559  |  |
|  |             | <i>168"W: 2 Piece Top</i> |     |    |        |         |          |            |  |
|               | 96-60168RTK | HPL                       | 168 | 60 | 1 3/16 | 449     | 24.8     | P\$ 9062   |  |
|  | 95-60168RTK | Veneer                    |     |    |        |         |          | W\$ 9777   |  |
|  |             | <i>144"W: 2 Piece Top</i> |     |    |        |         |          |            |  |
|               | 96-60144RTK | HPL                       | 144 | 60 | 1 3/16 | 388     | 21.4     | P\$ 7586   |  |
|  | 95-60144RTK | Veneer                    |     |    |        |         |          | W\$ 9118   |  |
|  |             | <i>120"W: 2 Piece Top</i> |     |    |        |         |          |            |  |
|  | 96-60120RTK | HPL                       | 120 | 60 | 1 3/16 | 332     | 18.0     | P\$ 6392   |  |
|  | 95-60120RTK | Veneer                    |     |    |        |         |          | W\$ 7527   |  |
|  |             | <i>108"W: 1 Piece Top</i> |     |    |        |         |          |            |  |
|  | 96-60108RTK | HPL                       | 108 | 60 | 1 3/16 | 301     | 16.3     | P\$ 5590   |  |
|  | 95-60108RTK | Veneer                    |     |    |        |         |          | W\$ 7439   |  |
|  |             | <i>96"W: 1 Piece Top</i>  |     |    |        |         |          |            |  |
|  | 96-6096RTK  | HPL                       | 96  | 60 | 1 3/16 | 262     | 14.6     | P\$ 5179   |  |
|  | 95-6096RTK  | Veneer                    |     |    |        |         |          | W\$ 6186   |  |
|  |             | <b>48"D Tops</b>          |     |    |        |         |          |            |  |
|  |             | <i>192"W: 2 Piece Top</i> |     |    |        |         |          |            |  |
|  | 96-48192RTK | HPL                       | 192 | 48 | 1 3/16 | 426     | 22.7     | P\$ 8209   |  |
|  | 95-48192RTK | Veneer                    |     |    |        |         |          | W\$ 9539   |  |
|  |             | <i>168"W: 2 Piece Top</i> |     |    |        |         |          |            |  |
|  | 96-48168RTK | HPL                       | 168 | 48 | 1 3/16 | 368     | 19.9     | P\$ 7803   |  |
|  | 95-48168RTK | Veneer                    |     |    |        |         |          | W\$ 8954   |  |
|  |             | <i>144"W: 2 Piece Top</i> |     |    |        |         |          |            |  |
| Rectangular 1 or 2-Piece<br>Top available with a<br>Block Edge and<br>coordinating Block Base. | 96-48144RTK | HPL                       | 144 | 48 | 1 3/16 | 318     | 17.1     | P\$ 6418   |  |
|  | 95-48144RTK | Veneer                    |     |    |        |         |          | W\$ 8289   |  |
|  |             | <i>120"W: 2 Piece Top</i> |     |    |        |         |          |            |  |
|  | 96-48120RTK | HPL                       | 120 | 48 | 1 3/16 | 269     | 14.3     | P\$ 5535   |  |
|  | 95-48120RTK | Veneer                    |     |    |        |         |          | W\$ 6509   |  |
|  |             | <i>108"W: 1 Piece Top</i> |     |    |        |         |          |            |  |
|  | 96-48108RTK | HPL                       | 108 | 48 | 1 3/16 | 234     | 12.9     | P\$ 5157   |  |
|  | 95-48108RTK | Veneer                    |     |    |        |         |          | W\$ 6221   |  |
|  |             | <i>96"W: 1 Piece Top</i>  |     |    |        |         |          |            |  |
|  | 96-4896RTK  | HPL                       | 96  | 48 | 1 3/16 | 205     | 11.5     | P\$ 4044   |  |
|  | 95-4896RTK  | Veneer                    |     |    |        |         |          | W\$ 5387   |  |

Must Specify (in this order):

- Model #
- Finish/Color
- Power/Data Location

[See Details.](#)

*Continued on next page.*

P = HPL W = Veneer

[See One10 Overview For Ordering Options](#)

| Item | Model No. | W | D | H | Ship Wt | Cubic Ft | List Price |
|------|-----------|---|---|---|---------|----------|------------|
|------|-----------|---|---|---|---------|----------|------------|

Continued from  
Previous Page

**What You Get:**

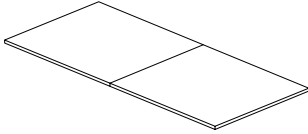

Top

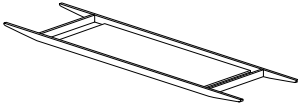

Trough

**Description**

- 1<sup>3</sup>/<sub>16</sub>" Rectangular Top with Knife Edge
- Veneer Tops Feature UV Finish on 48"D and Catalyzed Finish on 60"D
- Trough Reinforces and Supports Top
- Requires Two (2) Blade Bases; Tables 144"W or Larger Also Require Middle Blade Base; Sold Separately, See Below
- Power and Data Options Available; Sold Separately, [See Multiple Power Unit Details](#); [See Location Options](#)
- Assembly Required

**Top Grain Direction**

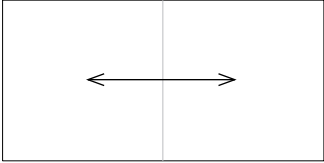

**BLADE BASES**

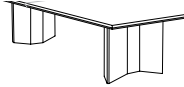

| <b>Blade Base Options; Must Order</b>                        |          |    |                               |    |    |     |          |
|--|----------|----|-------------------------------|----|----|-----|----------|
| <i>Standard Blade Base - Two (2) Required</i>                |          |    |                               |    |    |     |          |
| 96-2828BD  | HPL      | 28 | 10½                           | 28 | 52 | 2.4 | P\$ 1210 |
| 95-2828BD  | Veneer   |    |                               |    |    |     | W\$ 1666 |
| <i>Middle Blade Base - Required for Tops 144"W or Larger</i> |          |    |                               |    |    |     |          |
| 96-2818MBD   | Aluminum | 18 | 3 <sup>3</sup> / <sub>8</sub> | 28 | 72 | 2.8 | \$ 1602  |
| 95-2818MBD   | Aluminum |    |                               |    |    |     | \$ 1602  |

**Description**

- All Tops Require Two (2) Blade Bases; Tables 144"W or Larger Also Require Middle Blade Base
- Bases are Constructed with Removable Interior Aluminum Panel for Wire Management Installation
- Aluminum Middle Blade Base Features Two (2) Aluminum Doors for Wire Management
- Outer Panel of Standard Blade Base can be Specified in a Contrasting Finish/Color from Top Finish/Color
- Adjustable Glides Included

Must Specify (in this order):

- Standard Base Model #
- Primary Finish/Color
- Middle Base Model # (If needed)

P = HPL W = Veneer C = Combination of Wood/Laminate

[See One10 Overview For Ordering Options](#)

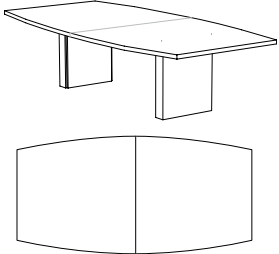
| Item  | Model No.                 |        | W       | D       | H   | Ship Wt | Cubic Ft | List Price |  |
|---|---------------------------|--------|---------|---------|-----|---------|----------|------------|--|
| <b>STANDARD TABLES</b>  |                           |        |         |         |     |         |          |            |  |
| <b>60"D Tops</b>  |                           |        |         |         |     |         |          |            |  |
| <i>192"W: 2 Piece Top</i>   |                           |        |         |         |     |         |          |            |  |
| <b>BOAT SHAPED<br/>1 OR 2 PIECE TOP<br/>BLOCK EDGE<br/>BLOCK BASE</b>  | 96-60192BTW               | HPL    | 192     | 60 - 48 | 1½  | 482     | 28.2     | P\$ 9133   |  |
|   | 95-60192BTW               | Veneer |         |         |     |         |          | W\$ 10182  |  |
|   | <i>168"W: 2 Piece Top</i> |        |         |         |     |         |          |            |  |
|   | 96-60168BTW               | HPL    | 168     | 60 - 48 | 1½  | 449     | 24.8     | P\$ 8498   |  |
|   | 95-60168BTW               | Veneer |         |         |     |         |          | W\$ 9428   |  |
|   | <i>144"W: 2 Piece Top</i> |        |         |         |     |         |          |            |  |
|   | 96-60144BTW               | HPL    | 144     | 60 - 48 | 1½  | 388     | 21.4     | P\$ 7114   |  |
|   | 95-60144BTW               | Veneer |         |         |     |         |          | W\$ 8791   |  |
|   | <i>120"W: 2 Piece Top</i> |        |         |         |     |         |          |            |  |
|   | 96-60120BTW               | HPL    | 120     | 60 - 48 | 1½  | 332     | 18.0     | P\$ 5989   |  |
| 95-60120BTW   | Veneer                    |        |         |         |     |         | W\$ 7054 |            |  |
| <i>108"W: 1 Piece Top</i>   |                           |        |         |         |     |         |          |            |  |
| 96-60108BTW   | HPL                       | 108    | 60 - 48 | 1½      | 301 | 16.3    | P\$ 5240 |            |  |
| 95-60108BTW   | Veneer                    |        |         |         |     |         | W\$ 6972 |            |  |
| <i>96"W: 1 Piece Top</i>  |                           |        |         |         |     |         |          |            |  |
| 96-6096BTW  | HPL                       | 96     | 60 - 48 | 1½      | 262 | 14.6    | P\$ 4853 |            |  |
| 95-6096BTW  | Veneer                    |        |         |         |     |         | W\$ 5800 |            |  |
| <b>48"D Tops</b>  |                           |        |         |         |     |         |          |            |  |
| <i>192"W: 2 Piece Top</i>   |                           |        |         |         |     |         |          |            |  |
| 96-48192BTW   | HPL                       | 192    | 48 - 36 | 1½      | 426 | 22.7    | P\$ 7699 |            |  |
| 95-48192BTW   | Veneer                    |        |         |         |     |         | W\$ 8941 |            |  |
| <i>168"W: 2 Piece Top</i>   |                           |        |         |         |     |         |          |            |  |
| 96-48168BTW   | HPL                       | 168    | 48 - 36 | 1½      | 368 | 19.9    | P\$ 7313 |            |  |
| 95-48168BTW   | Veneer                    |        |         |         |     |         | W\$ 8397 |            |  |
| <i>144"W: 2 Piece Top</i>   |                           |        |         |         |     |         |          |            |  |
| 96-48144BTW   | HPL                       | 144    | 48 - 36 | 1½      | 318 | 17.1    | P\$ 6018 |            |  |
| 95-48144BTW   | Veneer                    |        |         |         |     |         | W\$ 7774 |            |  |
| <i>120"W: 2 Piece Top</i>   |                           |        |         |         |     |         |          |            |  |
| 96-48120BTW   | HPL                       | 120    | 48 - 36 | 1½      | 269 | 14.3    | P\$ 5187 |            |  |
| 95-48120BTW   | Veneer                    |        |         |         |     |         | W\$ 6103 |            |  |
| <i>108"W: 1 Piece Top</i>   |                           |        |         |         |     |         |          |            |  |
| 96-48108BTW   | HPL                       | 108    | 48 - 36 | 1½      | 234 | 12.9    | P\$ 4837 |            |  |
| 95-48108BTW   | Veneer                    |        |         |         |     |         | W\$ 5832 |            |  |
| <i>96"W: 1 Piece Top</i>  |                           |        |         |         |     |         |          |            |  |
| 96-4896BTW  | HPL                       | 96     | 48 - 36 | 1½      | 205 | 11.5    | P\$ 3791 |            |  |
| 95-4896BTW  | Veneer                    |        |         |         |     |         | W\$ 5049 |            |  |

Must Specify (in this order):

- Model #
- Finish/Color
- Power/Data Location

Boat-Shaped 1 or 2-Piece Top available with a Knife Edge and coordinating Blade Base.

[See Details.](#)

*Continued on next page.*

P = HPL W = Veneer

[See One10 Overview For Ordering Options](#)

| Item | Model No. | W | D | H | Ship Wt | Cubic Ft | List Price |
|------|-----------|---|---|---|---------|----------|------------|
|------|-----------|---|---|---|---------|----------|------------|

Continued from  
Previous Page

**What You Get:**

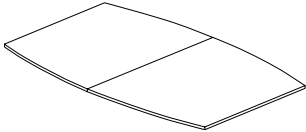

Top

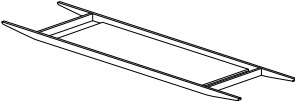

Trough

**Description**

- 1½" Thick Boat-Shaped Top with Block Edge
- Veneer Tops Feature UV Finish on 48"D and Catalyzed Finish on 60"D
- Trough Reinforces and Supports Top
- Requires Two (2) Block Bases; Tables 144"W or Larger Also Require Middle Block Base; Sold Separately, See Below
- Power and Data Options Available; Sold Separately, [See Multiple Power Unit Details](#); [See Location Options](#)
- Assembly Required

**Top Grain Direction**

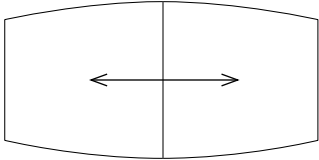

**BLOCK BASES**

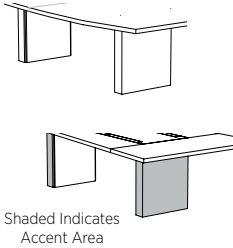

Shaded Indicates  
Accent Area

| Block Base Options; Must Order                               |            |    |    |    |    |     |          |
|--|------------|----|----|----|----|-----|----------|
| <i>Standard Block Base - Two (2) Required</i>                |            |    |    |    |    |     |          |
| 96-2428BB  | HPL        | 24 | 6  | 28 | 52 | 2.4 | P\$ 1483 |
| 95-2428BB  | Veneer     |    |    |    |    |     | W\$ 2036 |
| 95-2428BB  | Veneer/HPL |    |    |    |    |     | C\$ 2280 |
| <i>Middle Block Base - Required for Tops 144"W or Larger</i> |            |    |    |    |    |     |          |
| 96-2428MSL   | HPL        | 24 | 7½ | 28 | 72 | 2.8 | P\$ 1811 |
| 95-2428MSL   | Veneer     |    |    |    |    |     | W\$ 2355 |
| 95-2428MSL   | Veneer/HPL |    |    |    |    |     | C\$ 2682 |

**Description**

- All Tops Require Two (2) Block Bases; Tables 144"W or Larger Also Require Middle Block Base
- Bases are Constructed with Removable Interior Panel for Wire Management Installation
- Outer Panel of can be Specified in a Contrasting Finish/Color from Top Finish/Color
- Adjustable Glides Included

Must Specify (in this order):

- Standard Base Model #
- Primary Finish/Color
- Accent Material
- Accent Finish/Color
- Middle Base Model # (If needed)
- Middle Base Primary Finish/Color
- Middle Base Accent Material
- Middle Base Accent Finish/Color

P = HPL W = Veneer C = Combination of Wood/Laminate

[See One10 Overview For Ordering Options](#)

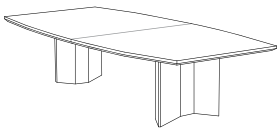
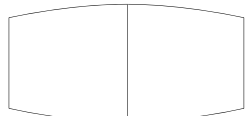
| Item  | Model No.   |                           | W   | D       | H      | Ship Wt | Cubic Ft | List Price |  |
|---|-------------|---------------------------|-----|---------|--------|---------|----------|------------|--|
| <b>STANDARD TABLES</b>  |             | <b>60"D Tops</b>          |     |         |        |         |          |            |  |
|   |             | <i>192"W: 2 Piece Top</i> |     |         |        |         |          |            |  |
| <b>BOAT SHAPED<br/>1 OR 2 PIECE TOP<br/>KNIFE EDGE<br/>BLADE BASE</b>                 | 96-60192BTK | HPL                       | 192 | 60 - 48 | 1 3/16 | 482     | 28.2     | P\$ 10228  |  |
|   | 95-60192BTK | Veneer                    |     |         |        |         |          | W\$ 11087  |  |
|   |             | <i>168"W: 2 Piece Top</i> |     |         |        |         |          |            |  |
|      | 96-60168BTK | HPL                       | 168 | 60 - 48 | 1 3/16 | 449     | 24.8     | P\$ 9516   |  |
|   | 95-60168BTK | Veneer                    |     |         |        |         |          | W\$ 10265  |  |
|   |             | <i>144"W: 2 Piece Top</i> |     |         |        |         |          |            |  |
|      | 96-60144BTK | HPL                       | 144 | 60 - 48 | 1 3/16 | 388     | 21.4     | P\$ 7965   |  |
|   | 95-60144BTK | Veneer                    |     |         |        |         |          | W\$ 9572   |  |
|   |             | <i>120"W: 2 Piece Top</i> |     |         |        |         |          |            |  |
|   | 96-60120BTK | HPL                       | 120 | 60 - 48 | 1 3/16 | 332     | 18.0     | P\$ 6710   |  |
|   | 95-60120BTK | Veneer                    |     |         |        |         |          | W\$ 7903   |  |
|   |             | <i>108"W: 1 Piece Top</i> |     |         |        |         |          |            |  |
|   | 96-60108BTK | HPL                       | 108 | 60 - 48 | 1 3/16 | 301     | 16.3     | P\$ 5870   |  |
|   | 95-60108BTK | Veneer                    |     |         |        |         |          | W\$ 7808   |  |
|   |             | <i>96"W: 1 Piece Top</i>  |     |         |        |         |          |            |  |
|   | 96-6096BTK  | HPL                       | 96  | 60 - 48 | 1 3/16 | 262     | 14.6     | P\$ 5438   |  |
|   | 95-6096BTK  | Veneer                    |     |         |        |         |          | W\$ 6493   |  |
|   |             | <b>48"D Tops</b>          |     |         |        |         |          |            |  |
|   |             | <i>192"W: 2 Piece Top</i> |     |         |        |         |          |            |  |
|   | 96-48192BTK | HPL                       | 192 | 48 - 36 | 1 3/16 | 426     | 22.7     | P\$ 8621   |  |
|   | 95-48192BTK | Veneer                    |     |         |        |         |          | W\$ 10017  |  |
|   |             | <i>168"W: 2 Piece Top</i> |     |         |        |         |          |            |  |
|   | 96-48168BTK | HPL                       | 168 | 48 - 36 | 1 3/16 | 368     | 19.9     | P\$ 8191   |  |
|   | 95-48168BTK | Veneer                    |     |         |        |         |          | W\$ 9401   |  |
|   |             | <i>144"W: 2 Piece Top</i> |     |         |        |         |          |            |  |
| Boat-Shaped 1 or 2-Piece Top available with a Block Edge and coordinating Block Base. | 96-48144BTK | HPL                       | 144 | 48 - 36 | 1 3/16 | 318     | 17.1     | P\$ 6736   |  |
|   | 95-48144BTK | Veneer                    |     |         |        |         |          | W\$ 8707   |  |
|   |             | <i>120"W: 2 Piece Top</i> |     |         |        |         |          |            |  |
|   | 96-48120BTK | HPL                       | 120 | 48 - 36 | 1 3/16 | 269     | 14.3     | P\$ 5811   |  |
|   | 95-48120BTK | Veneer                    |     |         |        |         |          | W\$ 6833   |  |
|   |             | <i>108"W: 1 Piece Top</i> |     |         |        |         |          |            |  |
|   | 96-48108BTK | HPL                       | 108 | 48 - 36 | 1 3/16 | 234     | 12.9     | P\$ 5417   |  |
|   | 95-48108BTK | Veneer                    |     |         |        |         |          | W\$ 6534   |  |
|   |             | <i>96"W: 1 Piece Top</i>  |     |         |        |         |          |            |  |
|   | 96-4896BTK  | HPL                       | 96  | 48 - 36 | 1 3/16 | 205     | 11.5     | P\$ 4247   |  |
|   | 95-4896BTK  | Veneer                    |     |         |        |         |          | W\$ 5659   |  |

Must Specify (in this order):

- Model #
- Finish/Color
- Power/Data Location

[See Details.](#)

*Continued on next page.*

P = HPL W = Veneer

[See One10 Overview For Ordering Options](#)



| Item | Model No. | W | D | H | Ship Wt | Cubic Ft | List Price |
|------|-----------|---|---|---|---------|----------|------------|
|------|-----------|---|---|---|---------|----------|------------|

Continued from  
Previous Page

**What You Get:**

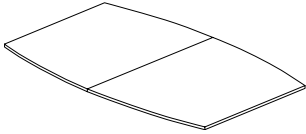

Top

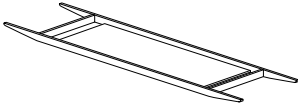

Trough

**Description**

- 1 $\frac{3}{16}$ " Rectangular Top with Knife Edge
- Veneer Tops Feature UV Finish on 48"D and Catalyzed Finish on 60"D
- Trough Reinforces and Supports Top
- Requires Two (2) Blade Bases; Tables 144"W or Larger Also Require Middle Blade Base; Sold Separately, See Below
- Power and Data Options Available; Sold Separately, [See Multiple Power Unit Details](#); [See Location Options](#)
- Assembly Required

**Top Grain Direction**

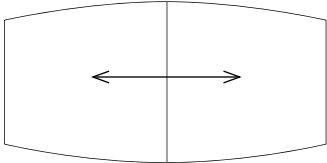

**BLADE BASES**

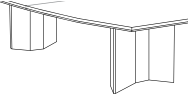

| <b>Blade Base Options; Must Order</b>                        |          |    |                  |    |    |     |          |
|--|----------|----|------------------|----|----|-----|----------|
| <i>Standard Blade Base - Two (2) Required</i>                |          |    |                  |    |    |     |          |
| 96-2828BD  | HPL      | 28 | 10 $\frac{1}{2}$ | 28 | 52 | 2.4 | P\$ 1210 |
| 95-2828BD  | Veneer   |    |                  |    |    |     | W\$ 1666 |
| <i>Middle Blade Base - Required for Tops 144"W or Larger</i> |          |    |                  |    |    |     |          |
| 96-2818MBD   | Aluminum | 18 | 3 $\frac{3}{8}$  | 28 | 72 | 2.8 | \$ 1602  |
| 95-2818MBD   | Aluminum |    |                  |    |    |     | \$ 1602  |

**Description**

- All Tops Require Two (2) Blade Bases; Tables 144"W or Larger Also Require Middle Blade Base
- Bases are Constructed with Removable Interior Aluminum Panel for Wire Management Installation
- Aluminum Middle Blade Base Features Two (2) Aluminum Doors for Wire Management
- Outer Panel of Standard Blade Base can be Specified in a Contrasting Finish/Color from Top Finish/Color
- Adjustable Glides Included

Must Specify (in this order):  
Standard Base Model #  
Primary Finish/Color  
Middle Base Model # (If needed)

P = HPL W = Veneer C = Combination of Wood/Laminate

[See One10 Overview For Ordering Options](#)

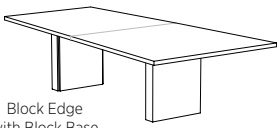
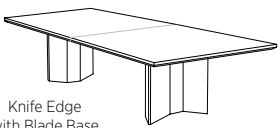
| Item   | Model No.   |  | W                         | D       | H   | Ship Wt | Cubic Ft  | List Price |  |  |
|--|-------------|--|---------------------------|---------|-----|---------|-----------|------------|--|--|
| <b>STANDARD TABLES</b>   |             | <b>Block Edge (Use with Block Base Only)</b> |                           |         |     |         |           |            |  |  |
|  |             | <i>192"W: 2 Piece Top</i>                    |                           |         |     |         |           |            |  |  |
| <b>VIEW SHAPED<br/>1 OR 2 PIECE TOP<br/>BLOCK EDGE W/BLOCK BASE<br/>OR KNIFE EDGE W/BLADE BASE</b><br><br><br>Block Edge with Block Base<br><br><br>Knife Edge with Blade Base | 96-60192VTV | HPL  | 192                       | 60 - 48 | 1½  | 482     | 28.2      | P\$ 9133   |  |  |
|  | 95-60192VTV | Veneer                                       |                           |         |     |         |           | W\$ 10182  |  |  |
|  |             |  | <i>168"W: 2 Piece Top</i> |         |     |         |           |            |  |  |
|  | 96-60168VTV | HPL  | 168                       | 60 - 48 | 1½  | 449     | 24.8      | P\$ 8498   |  |  |
|  | 95-60168VTV | Veneer                                       |                           |         |     |         |           | W\$ 9428   |  |  |
|  |             |  | <i>144"W: 2 Piece Top</i> |         |     |         |           |            |  |  |
|  | 96-60144VTV | HPL  | 144                       | 60 - 48 | 1½  | 388     | 21.4      | P\$ 7114   |  |  |
|  | 95-60144VTV | Veneer                                       |                           |         |     |         |           | W\$ 8791   |  |  |
|  |             |  | <i>120"W: 2 Piece Top</i> |         |     |         |           |            |  |  |
|  | 96-60120VTV | HPL  | 120                       | 60 - 48 | 1½  | 332     | 18.0      | P\$ 5989   |  |  |
| 95-60120VTV  | Veneer      |  |                           |         |     |         | W\$ 7054  |            |  |  |
|  |             | <i>108"W: 1 Piece Top</i>                    |                           |         |     |         |           |            |  |  |
| 96-60108VTV  | HPL         | 108  | 60 - 48                   | 1½      | 301 | 16.3    | P\$ 5240  |            |  |  |
| 95-60108VTV  | Veneer      |  |                           |         |     |         | W\$ 6972  |            |  |  |
|  |             | <i>96"W: 1 Piece Top</i>                     |                           |         |     |         |           |            |  |  |
| 96-6096VTV   | HPL         | 96   | 60 - 48                   | 1½      | 262 | 14.6    | P\$ 4853  |            |  |  |
| 95-6096VTV   | Veneer      |  |                           |         |     |         | W\$ 5800  |            |  |  |
|  |             | <b>Knife Edge (Use with Blade Base Only)</b> |                           |         |     |         |           |            |  |  |
|  |             | <i>192"W: 2 Piece Top</i>                    |                           |         |     |         |           |            |  |  |
| 96-60192VTK  | HPL         | 192  | 60 - 48                   | 1¾      | 482 | 22.7    | P\$ 10228 |            |  |  |
| 95-60192VTK  | Veneer      |  |                           |         |     |         | W\$ 11087 |            |  |  |
|  |             | <i>168"W: 2 Piece Top</i>                    |                           |         |     |         |           |            |  |  |
| 96-60168VTK  | HPL         | 168  | 60 - 48                   | 1¾      | 449 | 19.9    | P\$ 9516  |            |  |  |
| 95-60168VTK  | Veneer      |  |                           |         |     |         | W\$ 10265 |            |  |  |
|  |             | <i>144"W: 2 Piece Top</i>                    |                           |         |     |         |           |            |  |  |
| 96-60144VTK  | HPL         | 144  | 60 - 48                   | 1¾      | 388 | 17.1    | P\$ 7965  |            |  |  |
| 95-60144VTK  | Veneer      |  |                           |         |     |         | W\$ 9572  |            |  |  |
|  |             | <i>120"W: 2 Piece Top</i>                    |                           |         |     |         |           |            |  |  |
| 96-60120VTK  | HPL         | 120  | 60 - 48                   | 1¾      | 332 | 14.3    | P\$ 6710  |            |  |  |
| 95-60120VTK  | Veneer      |  |                           |         |     |         | W\$ 7903  |            |  |  |
|  |             | <i>108"W: 1 Piece Top</i>                    |                           |         |     |         |           |            |  |  |
| 96-60108VTK  | HPL         | 108  | 60 - 48                   | 1¾      | 301 | 12.9    | P\$ 5870  |            |  |  |
| 95-60108VTK  | Veneer      |  |                           |         |     |         | W\$ 7808  |            |  |  |
|  |             | <i>96"W: 1 Piece Top</i>                     |                           |         |     |         |           |            |  |  |
| 96-6096VTK   | HPL         | 96   | 60 - 48                   | 1¾      | 262 | 11.5    | P\$ 5438  |            |  |  |
| 95-6096VTK   | Veneer      |  |                           |         |     |         | W\$ 6493  |            |  |  |

Must Specify (in this order):

- Model #
- Finish/Color
- Power/Data Location

*Continued on next page.*

P = HPL W = Veneer

[See One10 Overview For Ordering Options](#)

| Item | Model No. | W | D | H | Ship Wt | Cubic Ft | List Price |
|------|-----------|---|---|---|---------|----------|------------|
|------|-----------|---|---|---|---------|----------|------------|

Continued from  
Previous Page

**What You Get:**

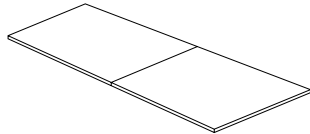

Top

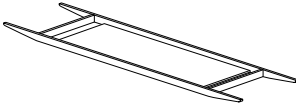

Trough

**Description**

- 1½" Thick View-Shaped Top with Block Edge or 1¾" Thick View-Shaped Top with Knife Edge
- Veneer Tops Feature UV Finish on 48"D and Catalyzed Finish on 60"D
- Trough Reinforces and Supports Top
- Requires Two (2) Block Bases (Block Edge) or Two (2) Blade Bases (Knife Edge); Tables 144"W or Larger Also Require Middle Base; Sold Separately, See Below
- Power and Data Options Available; Sold Separately, [See Multiple Power Unit Details](#); [See Location Options](#)
- Assembly Required

**Top Grain Direction**

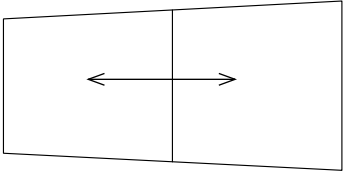

**BLOCK & BLADE BASES**

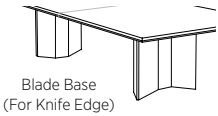
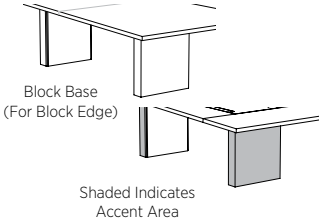

| <b>Block Base Options (For Block Edge Top Only); Must Order</b> |            |    |     |    |    |     |          |
|---|------------|----|-----|----|----|-----|----------|
| <i>Standard Block Base - Two (2) Required</i>                   |            |    |     |    |    |     |          |
| 96-2428BB   | HPL        | 24 | 6   | 28 | 52 | 2.4 | P\$ 1483 |
| 95-2428BB   | Veneer     |    |     |    |    |     | W\$ 2036 |
| 95-2428BB   | Veneer/HPL |    |     |    |    |     | C\$ 2280 |
| <i>Middle Block Base - Required for Tops 144"W or Larger</i>    |            |    |     |    |    |     |          |
| 96-2428MSL  | HPL        | 24 | 7½  | 28 | 72 | 2.8 | P\$ 1811 |
| 95-2428MSL  | Veneer     |    |     |    |    |     | W\$ 2355 |
| 95-2428MSL  | Veneer/HPL |    |     |    |    |     | C\$ 2682 |
| <b>Blade Base Options (For Knife Edge Top Only); Must Order</b> |            |    |     |    |    |     |          |
| <i>Standard Blade Base - Two (2) Required</i>                   |            |    |     |    |    |     |          |
| 96-2828BD   | HPL        | 28 | 10½ | 28 | 52 | 2.4 | P\$ 1210 |
| 95-2828BD   | Veneer     |    |     |    |    |     | W\$ 1666 |
| <i>Middle Blade Base - Required for Tops 144"W or Larger</i>    |            |    |     |    |    |     |          |
| 96-2818MBD  | Aluminum   | 18 | 3¾  | 28 | 72 | 2.8 | \$ 1602  |
| 95-2818MBD  | Aluminum   |    |     |    |    |     | \$ 1602  |

Must Specify (in this order):

- Standard Base Model #
- Primary Finish/Color
- Accent Material (Block)
- Accent Finish/Color (Block)
- Middle Base Model # (If needed)
- Middle Base Primary Finish/Color (Block)
- Middle Base Accent Material (Block)
- Middle Base Accent Finish/Color (Block)

**Description**

- All Tops Require Two (2) Bases; Tables 144"W or Larger Also Require Middle Base
- Bases are Constructed with Removable Interior Panel (Aluminum Interior Panel on Blade Bases) for Wire Management Installation
- Aluminum Middle Blade Base Features Two (2) Aluminum Doors for Wire Management
- Outer Panel of Standard Block Base, Middle Block Base or Standard Blade Base can be Specified in a Contrasting Finish/Color from Top Finish/Color
- Adjustable Glides Included

P = HPL W = Veneer C = Combination of Wood/Laminate

[See One10 Overview For Ordering Options](#)

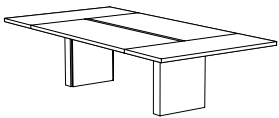
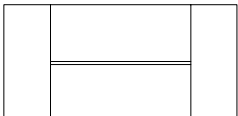
| Item  | Model No.    |                           | W   | D  | H  | Ship Wt | Cubic Ft | List Price |  |
|---|--------------|---------------------------|-----|----|----|---------|----------|------------|--|
| <b>STANDARD TABLES</b>  |              | <b>60"D Tops</b>          |     |    |    |         |          |            |  |
|   |              | <i>192"W: 7 Piece Top</i> |     |    |    |         |          |            |  |
| RECTANGULAR TOP<br>CENTER CHANNEL<br>BLOCK EDGE<br>BLOCK BASE   | 96-60192RTV4 | HPL                       | 192 | 60 | 1½ | 436     | 27.9     | P\$ 11635  |  |
|   | 95-60192RTV4 | Veneer                    |     |    |    |         |          | W\$ 13335  |  |
|   |              | <i>168"W: 7 Piece Top</i> |     |    |    |         |          |            |  |
|                                | 96-60168RTV4 | HPL                       | 168 | 60 | 1½ | 407     | 27.5     | P\$ 11084  |  |
|   | 95-60168RTV4 | Veneer                    |     |    |    |         |          | W\$ 12510  |  |
|   |              | <i>144"W: 7 Piece Top</i> |     |    |    |         |          |            |  |
|                                | 96-60144RTV4 | HPL                       | 144 | 60 | 1½ | 379     | 27.0     | P\$ 10538  |  |
|   | 95-60144RTV4 | Veneer                    |     |    |    |         |          | W\$ 11889  |  |
|   |              | <i>120"W: 4 Piece Top</i> |     |    |    |         |          |            |  |
|   | 96-60120RTV4 | HPL                       | 120 | 60 | 1½ | 345     | 26.6     | P\$ 6865   |  |
|   | 95-60120RTV4 | Veneer                    |     |    |    |         |          | W\$ 8190   |  |
|   |              | <i>108"W: 4 Piece Top</i> |     |    |    |         |          |            |  |
|   | 96-60108RTV4 | HPL                       | 108 | 60 | 1½ | 317     | 26.2     | P\$ 6610   |  |
|   | 95-60108RTV4 | Veneer                    |     |    |    |         |          | W\$ 7834   |  |
|   |              | <i>96"W: 4 Piece Top</i>  |     |    |    |         |          |            |  |
| Must Specify (in this order):<br>Model #<br>Finish/Color  | 96-6096RTV4  | HPL                       | 96  | 60 | 1½ | 289     | 25.8     | P\$ 6408   |  |
|   | 95-6096RTV4  | Veneer                    |     |    |    |         |          | W\$ 7459   |  |
|   |              | <b>48"D Tops</b>          |     |    |    |         |          |            |  |
|   |              | <i>192"W: 7 Piece Top</i> |     |    |    |         |          |            |  |
|   | 96-48192RTV4 | HPL                       | 192 | 48 | 1½ | 346     | 26.6     | P\$ 9746   |  |
|   | 95-48192RTV4 | Veneer                    |     |    |    |         |          | W\$ 11934  |  |
|   |              | <i>168"W: 7 Piece Top</i> |     |    |    |         |          |            |  |
|   | 96-48168RTV4 | HPL                       | 168 | 48 | 1½ | 329     | 26.3     | P\$ 9523   |  |
|   | 95-48168RTV4 | Veneer                    |     |    |    |         |          | W\$ 11065  |  |
|   |              | <i>144"W: 7 Piece Top</i> |     |    |    |         |          |            |  |
| Rectangular Table with<br>Center Channel also<br>available with a Knife<br>Edge and coordinating<br>Blade Base. | 96-48144RTV4 | HPL                       | 144 | 48 | 1½ | 312     | 26.0     | P\$ 9038   |  |
|   | 95-48144RTV4 | Veneer                    |     |    |    |         |          | W\$ 10532  |  |
|   |              | <i>120"W: 4 Piece Top</i> |     |    |    |         |          |            |  |
|   | 96-48120RTV4 | HPL                       | 120 | 48 | 1½ | 289     | 25.8     | P\$ 5825   |  |
|   | 95-48120RTV4 | Veneer                    |     |    |    |         |          | W\$ 7040   |  |
|   |              | <i>108"W: 4 Piece Top</i> |     |    |    |         |          |            |  |
| <a href="#">See Details.</a>  | 96-48108RTV4 | HPL                       | 108 | 48 | 1½ | 266     | 25.5     | P\$ 5629   |  |
|   | 95-48108RTV4 | Veneer                    |     |    |    |         |          | W\$ 6949   |  |
|   |              | <i>96"W: 4 Piece Top</i>  |     |    |    |         |          |            |  |
|   | 96-4896RTV4  | HPL                       | 96  | 48 | 1½ | 244     | 25.1     | P\$ 5505   |  |
|   | 95-4896RTV4  | Veneer                    |     |    |    |         |          | W\$ 6594   |  |

*Continued on next page.*

P = HPL W = Veneer

[See One10 Overview For Ordering Options](#)

| Item | Model No. | W | D | H | Ship Wt | Cubic Ft | List Price |
|------|-----------|---|---|---|---------|----------|------------|
|------|-----------|---|---|---|---------|----------|------------|

Continued from  
Previous Page

**What You Get:**

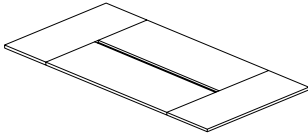

Top

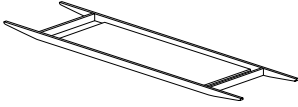

Trough

**Description**

- 1½” Thick Rectangular Top with Block Edge
- Veneer Tops Feature UV Finish
- 2” Center Channel in Top for Wire Management
- Trough Reinforces and Supports Top
- Requires Two (2) Block Bases; Tables 144”W or Larger Also Require Middle Block Base; Sold Separately, See Below
- Power and Data Options Available; Sold Separately, [See Multiple Power Unit Details](#); For Installation Convenience, the Trough has Pre-Drilled Peck-Hole Locations from the Bottom Side, [See Location Options](#)
- Assembly Required

**Top Grain Direction**

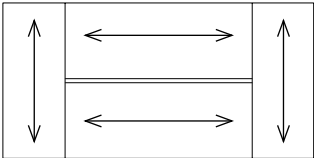

**BLOCK BASES**

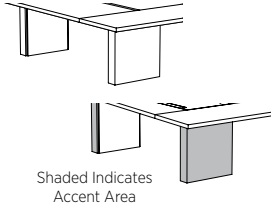

Shaded Indicates  
Accent Area

| Block Base Options; Must Order                               |            |    |    |    |    |     |          |
|--|------------|----|----|----|----|-----|----------|
| <i>Standard Block Base - Two (2) Required</i>                |            |    |    |    |    |     |          |
| 96-2428BB  | HPL        | 24 | 6  | 28 | 52 | 2.4 | P\$ 1483 |
| 95-2428BB  | Veneer     |    |    |    |    |     | W\$ 2036 |
| 95-2428BB  | Veneer/HPL |    |    |    |    |     | C\$ 2280 |
| <i>Middle Block Base - Required for Tops 144”W or Larger</i> |            |    |    |    |    |     |          |
| 96-2428MSL   | HPL        | 24 | 7½ | 28 | 72 | 2.8 | P\$ 1811 |
| 95-2428MSL   | Veneer     |    |    |    |    |     | W\$ 2355 |
| 95-2428MSL   | Veneer/HPL |    |    |    |    |     | C\$ 2682 |

**Must Specify (in this order):**

- Standard Base Model #
- Primary Finish/Color
- Accent Material
- Accent Finish/Color
- Middle Base Model # (If needed)
- Middle Base Primary Finish/Color
- Middle Base Accent Material
- Middle Base Accent Finish/Color

**Description**

- All Tops Require Two (2) Block Bases; Tables 144”W or Larger Also Require Middle Block Base
- Bases are Constructed with Removable Interior Panel for Wire Management Installation
- Outer Panel can be Specified in Contrasting Finish/Color from Top Finish/Color
- Adjustable Glides Included

P = HPL W = Veneer C = Combination of Wood/Laminate

[See One10 Overview For Ordering Options](#)

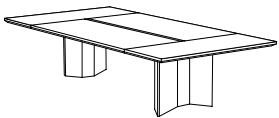
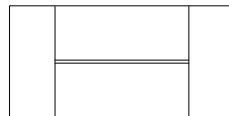
| Item  | Model No.    |                           | W   | D  | H      | Ship Wt | Cubic Ft | List Price |  |
|---|--------------|---------------------------|-----|----|--------|---------|----------|------------|--|
| <b>STANDARD TABLES</b>  |              | <b>60"D Tops</b>          |     |    |        |         |          |            |  |
|   |              | <i>192"W: 7 Piece Top</i> |     |    |        |         |          |            |  |
| RECTANGULAR TOP<br>CENTER CHANNEL<br>KNIFE EDGE<br>BLADE BASE   | 96-60192RTK4 | HPL                       | 192 | 60 | 1 3/16 | 436     | 27.9     | P\$ 13034  |  |
|   | 95-60192RTK4 | Veneer                    |     |    |        |         |          | W\$ 14937  |  |
|   |              | <i>168"W: 7 Piece Top</i> |     |    |        |         |          |            |  |
|                                | 96-60168RTK4 | HPL                       | 168 | 60 | 1 3/16 | 407     | 27.5     | P\$ 12414  |  |
|   | 95-60168RTK4 | Veneer                    |     |    |        |         |          | W\$ 14012  |  |
|   |              | <i>144"W: 7 Piece Top</i> |     |    |        |         |          |            |  |
|                                | 96-60144RTK4 | HPL                       | 144 | 60 | 1 3/16 | 379     | 27.0     | P\$ 11802  |  |
|   | 95-60144RTK4 | Veneer                    |     |    |        |         |          | W\$ 13318  |  |
|   |              | <i>120"W: 4 Piece Top</i> |     |    |        |         |          |            |  |
|   | 96-60120RTK4 | HPL                       | 120 | 60 | 1 3/16 | 345     | 26.6     | P\$ 7687   |  |
|   | 95-60120RTK4 | Veneer                    |     |    |        |         |          | W\$ 9171   |  |
|   |              | <i>108"W: 4 Piece Top</i> |     |    |        |         |          |            |  |
|   | 96-60108RTK4 | HPL                       | 108 | 60 | 1 3/16 | 317     | 26.2     | P\$ 7401   |  |
|   | 95-60108RTK4 | Veneer                    |     |    |        |         |          | W\$ 8774   |  |
|   |              | <i>96"W: 4 Piece Top</i>  |     |    |        |         |          |            |  |
| Must Specify (in this order):<br>Model #<br>Finish/Color  | 96-6096RTK4  | HPL                       | 96  | 60 | 1 3/16 | 289     | 25.8     | P\$ 7174   |  |
|   | 95-6096RTK4  | Veneer                    |     |    |        |         |          | W\$ 8355   |  |
|   |              | <b>48"D Tops</b>          |     |    |        |         |          |            |  |
|   |              | <i>192"W: 7 Piece Top</i> |     |    |        |         |          |            |  |
|   | 96-48192RTK4 | HPL                       | 192 | 48 | 1 3/16 | 346     | 26.6     | P\$ 10914  |  |
|   | 95-48192RTK4 | Veneer                    |     |    |        |         |          | W\$ 13366  |  |
|   |              | <i>168"W: 7 Piece Top</i> |     |    |        |         |          |            |  |
|   | 96-48168RTK4 | HPL                       | 168 | 48 | 1 3/16 | 329     | 26.3     | P\$ 10665  |  |
|   | 95-48168RTK4 | Veneer                    |     |    |        |         |          | W\$ 12393  |  |
|   |              | <i>144"W: 7 Piece Top</i> |     |    |        |         |          |            |  |
| Rectangular Table with<br>Center Channel also<br>available with a Block<br>Edge and coordinating<br>Block Base. | 96-48144RTK4 | HPL                       | 144 | 48 | 1 3/16 | 312     | 26.0     | P\$ 10121  |  |
|   | 95-48144RTK4 | Veneer                    |     |    |        |         |          | W\$ 11794  |  |
|   |              | <i>120"W: 4 Piece Top</i> |     |    |        |         |          |            |  |
|   | 96-48120RTK4 | HPL                       | 120 | 48 | 1 3/16 | 289     | 25.8     | P\$ 6522   |  |
|   | 95-48120RTK4 | Veneer                    |     |    |        |         |          | W\$ 7885   |  |
|   |              | <i>108"W: 4 Piece Top</i> |     |    |        |         |          |            |  |
| <a href="#">See Details.</a>  | 96-48108RTK4 | HPL                       | 108 | 48 | 1 3/16 | 266     | 25.5     | P\$ 6305   |  |
|   | 95-48108RTK4 | Veneer                    |     |    |        |         |          | W\$ 7784   |  |
|   |              | <i>96"W: 4 Piece Top</i>  |     |    |        |         |          |            |  |
|   | 96-4896RTK4  | HPL                       | 96  | 48 | 1 3/16 | 244     | 25.1     | P\$ 6168   |  |
|   | 95-4896RTK4  | Veneer                    |     |    |        |         |          | W\$ 7386   |  |

Continued on next page.

P = HPL W = Veneer

[See One10 Overview For Ordering Options](#)

| Item | Model No. | W | D | H | Ship Wt | Cubic Ft | List Price |
|------|-----------|---|---|---|---------|----------|------------|
|------|-----------|---|---|---|---------|----------|------------|

Continued from  
Previous Page

**What You Get:**

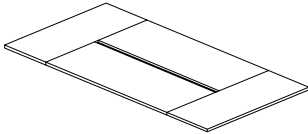

Top

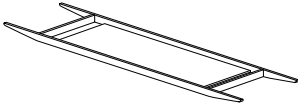

Trough

**Description**

- 1 $\frac{3}{16}$ " Rectangular Top with Knife Edge
- Veneer Tops Feature UV Finish
- 2" Center Channel in Top for Wire Management
- Trough Reinforces and Supports Top
- Requires Two (2) Blade Bases; Tables 144"W or Larger Also Require Middle Blade Base; Sold Separately, See Below
- Power and Data Options Available; Sold Separately, [See Multiple Power Unit Details](#); For Installation Convenience, the Trough has Pre-Drilled Peck-Hole Locations from the Bottom Side, [See Location Options](#)
- Assembly Required

**Top Grain Direction**

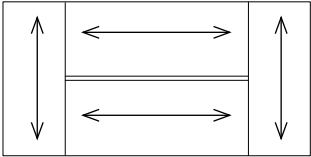

**BLADE BASES**



**Must Specify (in this order):**

- Standard Base Model #
- Primary Finish/Color
- Middle Base Model # (If needed)



| Blade Base Options; Must Order                               |          |    |                  |    |    |     |     |      |
|--|----------|----|------------------|----|----|-----|-----|------|
| <i>Standard Blade Base - Two (2) Required</i>                |          |    |                  |    |    |     |     |      |
| 96-2828BD  | HPL      | 28 | 10 $\frac{1}{2}$ | 28 | 52 | 2.4 | P\$ | 1210 |
| 95-2828BD  | Veneer   |    |                  |    |    |     | W\$ | 1666 |
| <i>Middle Blade Base - Required for Tops 144"W or Larger</i> |          |    |                  |    |    |     |     |      |
| 96-2818MBD   | Aluminum | 18 | 3 $\frac{7}{8}$  | 28 | 72 | 2.8 | \$  | 1602 |
| 95-2818MBD   | Aluminum |    |                  |    |    |     | \$  | 1602 |

**Description**

- All Tops Require Two (2) Blade Bases; Tables 144"W or Larger Also Require Middle Blade Base
- Bases are Constructed with Removable Interior Aluminum Panel for Wire Management Installation
- Aluminum Middle Blade Base Features Two (2) Aluminum Doors for Wire Management
- Outer Panel of Standard Blade Base can be Specified in a Contrasting Finish/Color from Top Finish/Color
- Adjustable Glides Included

P = HPL W = Veneer C = Combination of Wood/Laminate

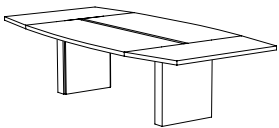
[See One10 Overview For Ordering Options](#)

| Item   | Model No.    |                           | W   | D       | H  | Ship Wt | Cubic Ft | List Price |  |
|--|--------------|---------------------------|-----|---------|----|---------|----------|------------|--|
| <b>STANDARD TABLES</b>   |              | <b>60"D Tops</b>          |     |         |    |         |          |            |  |
|  |              | <i>192"W: 7 Piece Top</i> |     |         |    |         |          |            |  |
| <b>BOAT-SHAPED TOP<br/>CENTER CHANNEL<br/>BLOCK EDGE<br/>BLOCK BASE</b>  | 96-60192BTV4 | HPL                       | 192 | 60 - 48 | 1½ | 436     | 27.9     | P\$ 12218  |  |
|  | 95-60192BTV4 | Veneer                    |     |         |    |         |          | W\$ 14002  |  |
|  |              | <i>168"W: 7 Piece Top</i> |     |         |    |         |          |            |  |
|   | 96-60168BTV4 | HPL                       | 168 | 60 - 48 | 1½ | 407     | 27.5     | P\$ 11635  |  |
|  | 95-60168BTV4 | Veneer                    |     |         |    |         |          | W\$ 13137  |  |
|  |              | <i>144"W: 7 Piece Top</i> |     |         |    |         |          |            |  |
|   | 96-60144BTV4 | HPL                       | 144 | 60 - 48 | 1½ | 379     | 27.0     | P\$ 11065  |  |
|  | 95-60144BTV4 | Veneer                    |     |         |    |         |          | W\$ 12485  |  |
|  |              | <i>120"W: 4 Piece Top</i> |     |         |    |         |          |            |  |
|  | 96-60120BTV4 | HPL                       | 120 | 60 - 48 | 1½ | 345     | 26.6     | P\$ 7208   |  |
|  | 95-60120BTV4 | Veneer                    |     |         |    |         |          | W\$ 8598   |  |
|  |              | <i>108"W: 4 Piece Top</i> |     |         |    |         |          |            |  |
|  | 96-60108BTV4 | HPL                       | 108 | 60 - 48 | 1½ | 317     | 26.2     | P\$ 6940   |  |
|  | 95-60108BTV4 | Veneer                    |     |         |    |         |          | W\$ 8224   |  |
|  |              | <i>96"W: 4 Piece Top</i>  |     |         |    |         |          |            |  |
| <b>Must Specify (in this order):</b><br>Model #<br>Finish/Color  | 96-6096BTV4  | HPL                       | 96  | 60 - 48 | 1½ | 289     | 25.8     | P\$ 6728   |  |
|  | 95-6096BTV4  | Veneer                    |     |         |    |         |          | W\$ 7832   |  |
|  |              | <b>48"D Tops</b>          |     |         |    |         |          |            |  |
|  |              | <i>192"W: 7 Piece Top</i> |     |         |    |         |          |            |  |
|  | 96-48192BTV4 | HPL                       | 192 | 48 - 36 | 1½ | 346     | 26.6     | P\$ 10230  |  |
|  | 95-48192BTV4 | Veneer                    |     |         |    |         |          | W\$ 12533  |  |
|  |              | <i>168"W: 7 Piece Top</i> |     |         |    |         |          |            |  |
|  | 96-48168BTV4 | HPL                       | 168 | 48 - 36 | 1½ | 329     | 26.3     | P\$ 9998   |  |
|  | 95-48168BTV4 | Veneer                    |     |         |    |         |          | W\$ 11616  |  |
|  |              | <i>144"W: 7 Piece Top</i> |     |         |    |         |          |            |  |
| <b>Boat-Shaped Table with<br/>Center Channel also<br/>available with a Knife<br/>Edge and coordinating<br/>Blade Base.</b> | 96-48144BTV4 | HPL                       | 144 | 48 - 36 | 1½ | 312     | 26.0     | P\$ 9487   |  |
|  | 95-48144BTV4 | Veneer                    |     |         |    |         |          | W\$ 11057  |  |
|  |              | <i>120"W: 4 Piece Top</i> |     |         |    |         |          |            |  |
|  | 96-48120BTV4 | HPL                       | 120 | 48 - 36 | 1½ | 289     | 25.8     | P\$ 6115   |  |
|  | 95-48120BTV4 | Veneer                    |     |         |    |         |          | W\$ 7391   |  |
|  |              | <i>108"W: 4 Piece Top</i> |     |         |    |         |          |            |  |
| <a href="#">See Details.</a>   | 96-48108BTV4 | HPL                       | 108 | 48 - 36 | 1½ | 266     | 25.5     | P\$ 5911   |  |
|  | 95-48108BTV4 | Veneer                    |     |         |    |         |          | W\$ 7298   |  |
|  |              | <i>96"W: 4 Piece Top</i>  |     |         |    |         |          |            |  |
|  | 96-4896BTV4  | HPL                       | 96  | 48 - 36 | 1½ | 244     | 25.1     | P\$ 5781   |  |
|  | 95-4896BTV4  | Veneer                    |     |         |    |         |          | W\$ 6924   |  |

*Continued on next page.*

P = HPL W = Veneer

[See One10 Overview For Ordering Options](#)



| Item | Model No. | W | D | H | Ship Wt | Cubic Ft | List Price |
|------|-----------|---|---|---|---------|----------|------------|
|------|-----------|---|---|---|---------|----------|------------|

Continued from  
Previous Page

**What You Get:**

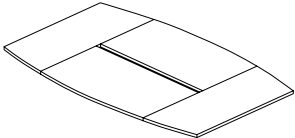

Top

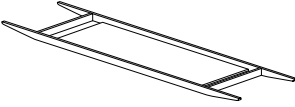

Trough

**Description**

- 1½" Thick Boat-Shaped Top with Block Edge
- Veneer Tops Feature UV Finish
- 2" Center Channel in Top for Wire Management
- Trough Reinforces and Supports Top
- Requires Two (2) Block Bases; Tables 144"W or Larger Also Require Middle Block Base; Sold Separately, See Below
- Power and Data Options Available; Sold Separately, [See Multiple Power Unit Details](#); For Installation Convenience, the Trough has Pre-Drilled Peck-Hole Locations from the Bottom Side, [See Location Options](#)
- Assembly Required

**Top Grain Direction**

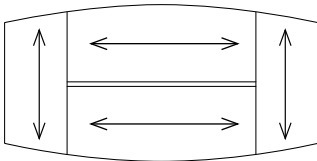

**BLOCK BASES**

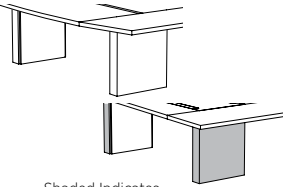

Shaded Indicates  
Accent Area

| Block Base Options; Must Order                               |            |    |    |    |    |     |          |
|--|------------|----|----|----|----|-----|----------|
| <i>Standard Block Base - Two (2) Required</i>                |            |    |    |    |    |     |          |
| 96-2428BB  | HPL        | 24 | 6  | 28 | 52 | 2.4 | P\$ 1483 |
| 95-2428BB  | Veneer     |    |    |    |    |     | W\$ 2036 |
| 95-2428BB  | Veneer/HPL |    |    |    |    |     | C\$ 2280 |
| <i>Middle Block Base - Required for Tops 144"W or Larger</i> |            |    |    |    |    |     |          |
| 96-2428MSL   | HPL        | 24 | 7½ | 28 | 72 | 2.8 | P\$ 1811 |
| 95-2428MSL   | Veneer     |    |    |    |    |     | W\$ 2355 |
| 95-2428MSL   | Veneer/HPL |    |    |    |    |     | C\$ 2682 |

**Description**



- All Tops Require Two (2) Block Bases; Tables 144"W or Larger Also Require Middle Block Base
- Bases are Constructed with Removable Interior Panel for Wire Management Installation
- Outer Panel can be Specified in Contrasting Finish/Color from Top Finish/Color
- Adjustable Glides Included

**Must Specify (in this order):**

- Standard Base Model #
- Primary Finish/Color
- Accent Material
- Accent Finish/Color
- Middle Base Model # (If needed)
- Middle Base Primary Finish/Color
- Middle Base Accent Material
- Middle Base Accent Finish/Color

P = HPL W = Veneer C = Combination of Wood/Laminate

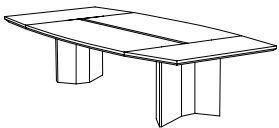
[See One10 Overview For Ordering Options](#)

| Item   | Model No.    |                           | W   | D       | H      | Ship Wt | Cubic Ft | List Price |  |
|--|--------------|---------------------------|-----|---------|--------|---------|----------|------------|--|
| <b>STANDARD TABLES</b>   |              | <b>60"D Tops</b>          |     |         |        |         |          |            |  |
|  |              | <i>192"W: 7 Piece Top</i> |     |         |        |         |          |            |  |
| <b>BOAT-SHAPED TOP<br/>CENTER CHANNEL<br/>KNIFE EDGE<br/>BLADE BASE</b>  | 96-60192BTK4 | HPL                       | 192 | 60 - 48 | 1 3/16 | 436     | 27.9     | P\$ 13685  |  |
|  | 95-60192BTK4 | Veneer                    |     |         |        |         |          | W\$ 15682  |  |
|  |              | <i>168"W: 7 Piece Top</i> |     |         |        |         |          |            |  |
|   | 96-60168BTK4 | HPL                       | 168 | 60 - 48 | 1 3/16 | 407     | 27.5     | P\$ 13034  |  |
|  | 95-60168BTK4 | Veneer                    |     |         |        |         |          | W\$ 14713  |  |
|  |              | <i>144"W: 7 Piece Top</i> |     |         |        |         |          |            |  |
|   | 96-60144BTK4 | HPL                       | 144 | 60 - 48 | 1 3/16 | 379     | 27.0     | P\$ 12391  |  |
|  | 95-60144BTK4 | Veneer                    |     |         |        |         |          | W\$ 13984  |  |
|  |              | <i>120"W: 4 Piece Top</i> |     |         |        |         |          |            |  |
|  | 96-60120BTK4 | HPL                       | 120 | 60 - 48 | 1 3/16 | 345     | 26.6     | P\$ 8074   |  |
|  | 95-60120BTK4 | Veneer                    |     |         |        |         |          | W\$ 9627   |  |
|  |              | <i>108"W: 4 Piece Top</i> |     |         |        |         |          |            |  |
|  | 96-60108BTK4 | HPL                       | 108 | 60 - 48 | 1 3/16 | 317     | 26.2     | P\$ 7769   |  |
|  | 95-60108BTK4 | Veneer                    |     |         |        |         |          | W\$ 9210   |  |
|  |              | <i>96"W: 4 Piece Top</i>  |     |         |        |         |          |            |  |
| <u>Must Specify (in this order):</u><br>Model #<br>Finish/Color  | 96-6096BTK4  | HPL                       | 96  | 60 - 48 | 1 3/16 | 289     | 25.8     | P\$ 7538   |  |
|  | 95-6096BTK4  | Veneer                    |     |         |        |         |          | W\$ 8774   |  |
|  |              | <b>48"D Tops</b>          |     |         |        |         |          |            |  |
|  |              | <i>192"W: 7 Piece Top</i> |     |         |        |         |          |            |  |
|  | 96-48192BTK4 | HPL                       | 192 | 48 - 36 | 1 3/16 | 346     | 26.6     | P\$ 11461  |  |
|  | 95-48192BTK4 | Veneer                    |     |         |        |         |          | W\$ 14033  |  |
|  |              | <i>168"W: 7 Piece Top</i> |     |         |        |         |          |            |  |
|  | 96-48168BTK4 | HPL                       | 168 | 48 - 36 | 1 3/16 | 329     | 26.3     | P\$ 11198  |  |
|  | 95-48168BTK4 | Veneer                    |     |         |        |         |          | W\$ 13011  |  |
|  |              | <i>144"W: 7 Piece Top</i> |     |         |        |         |          |            |  |
| <b>Boat-Shaped Table with<br/>Center Channel also<br/>available with a Block<br/>Edge and coordinating<br/>Block Base.</b> | 96-48144BTK4 | HPL                       | 144 | 48 - 36 | 1 3/16 | 312     | 26.0     | P\$ 10628  |  |
|  | 95-48144BTK4 | Veneer                    |     |         |        |         |          | W\$ 12381  |  |
|  |              | <i>120"W: 4 Piece Top</i> |     |         |        |         |          |            |  |
|  | 96-48120BTK4 | HPL                       | 120 | 48 - 36 | 1 3/16 | 289     | 25.8     | P\$ 6850   |  |
|  | 95-48120BTK4 | Veneer                    |     |         |        |         |          | W\$ 8283   |  |
|  |              | <i>108"W: 4 Piece Top</i> |     |         |        |         |          |            |  |
| <a href="#">See Details.</a>   | 96-48108BTK4 | HPL                       | 108 | 48 - 36 | 1 3/16 | 266     | 25.5     | P\$ 6621   |  |
|  | 95-48108BTK4 | Veneer                    |     |         |        |         |          | W\$ 8171   |  |
|  |              | <i>96"W: 4 Piece Top</i>  |     |         |        |         |          |            |  |
|  | 96-4896BTK4  | HPL                       | 96  | 48 - 36 | 1 3/16 | 244     | 25.1     | P\$ 6475   |  |
|  | 95-4896BTK4  | Veneer                    |     |         |        |         |          | W\$ 7755   |  |

*Continued on next page.*

P = HPL W = Veneer

[See One10 Overview For Ordering Options](#)

| Item | Model No. | W | D | H | Ship Wt | Cubic Ft | List Price |
|------|-----------|---|---|---|---------|----------|------------|
|------|-----------|---|---|---|---------|----------|------------|

Continued from  
Previous Page

**What You Get:**

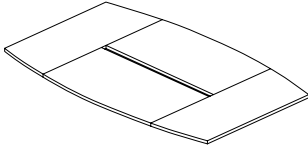

Top

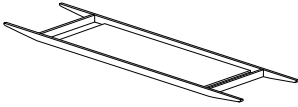

Trough

**Description**

- 1<sup>3</sup>/<sub>16</sub>" Rectangular Top with Knife Edge
- Veneer Tops Feature UV Finish
- 2" Center Channel in Top for Wire Management
- Trough Reinforces and Supports Top
- Requires Two (2) Blade Bases; Tables 144"W or Larger Also Require Middle Blade Base; Sold Separately, See Below
- Power and Data Options Available; Sold Separately, [See Multiple Power Unit Details](#); For Installation Convenience, the Trough has Pre-Drilled Peck-Hole Locations from the Bottom Side, [See Location Options](#)
- Assembly Required

**Top Grain Direction**

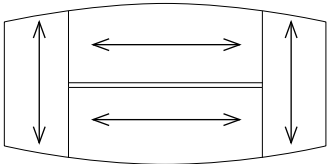

**BLADE BASES**



| Blade Base Options; Must Order                               |          |    |                               |    |    |     |          |
|--|----------|----|-------------------------------|----|----|-----|----------|
| <i>Standard Blade Base - Two (2) Required</i>                |          |    |                               |    |    |     |          |
| 96-2828BD  | HPL      | 28 | 10½                           | 28 | 52 | 2.4 | P\$ 1210 |
| 95-2828BD  | Veneer   |    |                               |    |    |     | W\$ 1666 |
| <i>Middle Blade Base - Required for Tops 144"W or Larger</i> |          |    |                               |    |    |     |          |
| 96-2818MBD   | Aluminum | 18 | 3 <sup>7</sup> / <sub>8</sub> | 28 | 72 | 2.8 | \$ 1602  |
| 95-2818MBD   | Aluminum |    |                               |    |    |     | \$ 1602  |

**Description**







- All Tops Require Two (2) Blade Bases; Tables 144"W or Larger Also Require Middle Blade Base
- Bases are Constructed with Removable Interior Aluminum Panel for Wire Management Installation
- Aluminum Middle Blade Base Features Two (2) Aluminum Doors for Wire Management
- Outer Panel of Standard Blade Base can be Specified in a Contrasting Finish/Color from Top Finish/Color
- Adjustable Glides Included

Must Specify (in this order):

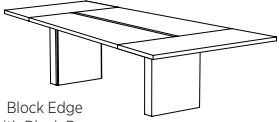
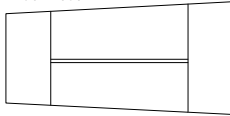
- Standard Base Model #
- Primary Finish/Color
- Middle Base Model # (If needed)

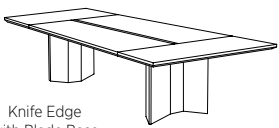
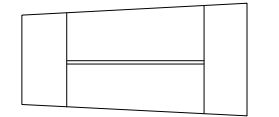
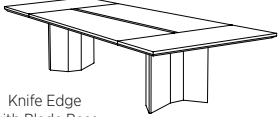
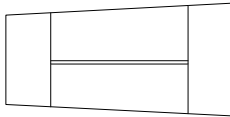
P = HPL W = Veneer C = Combination of Wood/Laminate

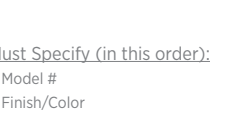
[See One10 Overview For Ordering Options](#)

| Item  | Model No.    |        | W   | D       | H  | Ship Wt | Cubic Ft | List Price |
|---|--------------|--------|-----|---------|----|---------|----------|------------|
| <b>STANDARD TABLES</b>  |              |        |     |         |    |         |          |            |
| <b>Block Edge (Use with Block Base Only)</b>  |              |        |     |         |    |         |          |            |
| <i>192"W: 7 Piece Top</i>   |              |        |     |         |    |         |          |            |
| <b>VIEW-SHAPED TOP<br/>CENTER CHANNEL<br/>BLOCK EDGE W/BLOCK BASE<br/>OR KNIFE EDGE W/BLADE BASE</b>              | 96-60192VTV4 | HPL    | 192 | 60 - 48 | 1½ | 436     | 27.9     | P\$ 12218  |
|   | 95-60192VTV4 | Veneer |     |         |    |         |          | W\$ 14002  |
| <i>168"W: 7 Piece Top</i>   |              |        |     |         |    |         |          |            |
| <br>Block Edge with Block Base   | 96-60168VTV4 | HPL    | 168 | 60 - 48 | 1½ | 407     | 27.5     | P\$ 11635  |
|   | 95-60168VTV4 | Veneer |     |         |    |         |          | W\$ 13137  |
| <i>144"W: 7 Piece Top</i>   |              |        |     |         |    |         |          |            |
|                                  | 96-60144VTV4 | HPL    | 144 | 60 - 48 | 1½ | 379     | 27.0     | P\$ 11065  |
|   | 95-60144VTV4 | Veneer |     |         |    |         |          | W\$ 12485  |
| <i>120"W: 4 Piece Top</i>   |              |        |     |         |    |         |          |            |
|                                  | 96-60120VTV4 | HPL    | 120 | 60 - 48 | 1½ | 345     | 26.6     | P\$ 7208   |
|   | 95-60120VTV4 | Veneer |     |         |    |         |          | W\$ 8598   |
| <i>108"W: 4 Piece Top</i>   |              |        |     |         |    |         |          |            |
| <br>Block Edge with Block Base   | 96-60108VTV4 | HPL    | 108 | 60 - 48 | 1½ | 317     | 26.2     | P\$ 6940   |
|   | 95-60108VTV4 | Veneer |     |         |    |         |          | W\$ 8224   |
| <i>96"W: 4 Piece Top</i>  |              |        |     |         |    |         |          |            |
| <br>Block Edge with Block Base  | 96-6096VTV4  | HPL    | 96  | 60 - 48 | 1½ | 289     | 25.8     | P\$ 6728   |
|   | 95-6096VTV4  | Veneer |     |         |    |         |          | W\$ 7832   |
| <b>Knife Edge (Use with Blade Base Only)</b>  |              |        |     |         |    |         |          |            |
| <i>192"W: 7 Piece Top</i>   |              |        |     |         |    |         |          |            |
| <br>Knife Edge with Blade Base   | 96-60192VTK4 | HPL    | 192 | 60 - 48 | 1⅜ | 436     | 27.9     | P\$ 13685  |
|   | 95-60192VTK4 | Veneer |     |         |    |         |          | W\$ 15682  |
| <i>168"W: 7 Piece Top</i>   |              |        |     |         |    |         |          |            |
|                                 | 96-60168VTK4 | HPL    | 168 | 60 - 48 | 1⅜ | 407     | 27.5     | P\$ 13034  |
|   | 95-60168VTK4 | Veneer |     |         |    |         |          | W\$ 14713  |
| <i>144"W: 7 Piece Top</i>   |              |        |     |         |    |         |          |            |
| <br>Knife Edge with Blade Base | 96-60144VTK4 | HPL    | 144 | 60 - 48 | 1⅜ | 379     | 27.0     | P\$ 12391  |
|   | 95-60144VTK4 | Veneer |     |         |    |         |          | W\$ 13984  |
| <i>120"W: 4 Piece Top</i>   |              |        |     |         |    |         |          |            |
|                                | 96-60120VTK4 | HPL    | 120 | 60 - 48 | 1⅜ | 345     | 26.6     | P\$ 8074   |
|   | 95-60120VTK4 | Veneer |     |         |    |         |          | W\$ 9627   |
| <i>108"W: 4 Piece Top</i>   |              |        |     |         |    |         |          |            |
| <br>Knife Edge with Blade Base | 96-60108VTK4 | HPL    | 108 | 60 - 48 | 1⅜ | 317     | 26.2     | P\$ 7769   |
|   | 95-60108VTK4 | Veneer |     |         |    |         |          | W\$ 9210   |
| <i>96"W: 4 Piece Top</i>  |              |        |     |         |    |         |          |            |
| <br>Knife Edge with Blade Base | 96-6096VTK4  | HPL    | 96  | 60 - 48 | 1⅜ | 289     | 25.8     | P\$ 7538   |
|   | 95-6096VTK4  | Veneer |     |         |    |         |          | W\$ 8774   |

Must Specify (in this order):

Model #  
Finish/Color

*Continued on next page.*

P = HPL W = Veneer

[See One10 Overview For Ordering Options](#)

| Item | Model No. | W | D | H | Ship Wt | Cubic Ft | List Price |
|------|-----------|---|---|---|---------|----------|------------|
|------|-----------|---|---|---|---------|----------|------------|

Continued from  
Previous Page

**What You Get:**

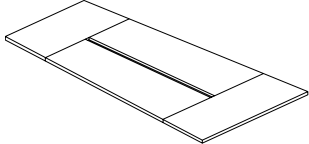

Top

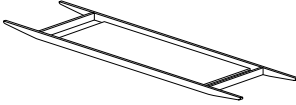

Trough

**Description**

- 1½" Thick View-Shaped Top with Block Edge or 1⅜" Thick View-Shaped Top with Knife Edge
- Veneer Tops Feature UV Finish
- 2" Center Channel in Top for Wire Management
- Trough Reinforces and Supports Top
- Requires Two (2) Block Bases (Block Edge) or Two (2) Blade Bases (Knife Edge); Tables 144"W or Larger Also Require Middle Base; Sold Separately, See Below
- Power and Data Options Available; Sold Separately, [See Multiple Power Unit Details](#); For Installation Convenience, the Trough has Pre-Drilled Peck-Hole Locations from the Bottom Side, [See Location Options](#)
- Assembly Required

**Top Grain Direction**

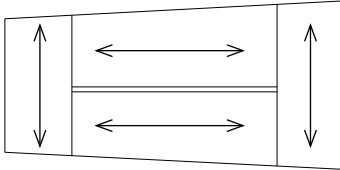

**BLOCK & BLADE BASES**

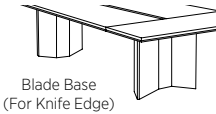
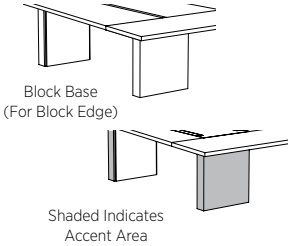

**Must Specify (in this order):**

- Standard Base Model #
- Primary Finish/Color
- Accent Material (Block)
- Accent Finish/Color (Block)
- Middle Base Model # (If needed)
- Middle Base Primary Finish/Color (Block)
- Middle Base Accent Material (Block)
- Middle Base Accent Finish/Color (Block)

**Block Base Options (For Block Edge Top Only); Must Order**

| <i>Standard Block Base - Two (2) Required</i>                |            |    |    |    |    |     |          |
|--|------------|----|----|----|----|-----|----------|
| 96-2428BB  | HPL        | 24 | 6  | 28 | 52 | 2.4 | P\$ 1483 |
| 95-2428BB  | Veneer     |    |    |    |    |     | W\$ 2036 |
| 95-2428BB  | Veneer/HPL |    |    |    |    |     | C\$ 2280 |
| <i>Middle Block Base - Required for Tops 144"W or Larger</i> |            |    |    |    |    |     |          |
| 96-2428MSL   | HPL        | 24 | 7½ | 28 | 72 | 2.8 | P\$ 1811 |
| 95-2428MSL   | Veneer     |    |    |    |    |     | W\$ 2355 |
| 95-2428MSL   | Veneer/HPL |    |    |    |    |     | C\$ 2682 |

**Blade Base Options (For Knife Edge Top Only); Must Order**

| <i>Standard Blade Base - Two (2) Required</i>                |          |    |     |    |    |     |          |
|--|----------|----|-----|----|----|-----|----------|
| 96-2828BD  | HPL      | 28 | 10½ | 28 | 52 | 2.4 | P\$ 1210 |
| 95-2828BD  | Veneer   |    |     |    |    |     | W\$ 1666 |
| <i>Middle Blade Base - Required for Tops 144"W or Larger</i> |          |    |     |    |    |     |          |
| 96-2818MBD   | Aluminum | 18 | 3⅞  | 28 | 72 | 2.8 | \$ 1602  |
| 95-2818MBD   | Aluminum |    |     |    |    |     | \$ 1602  |

**Description**

- All Tops Require Two (2) Bases; Tables 144"W or Larger Also Require Middle Base
- Bases are Constructed with Removable Interior Panel (Aluminum Interior Panel on Blade Bases) for Wire Management Installation
- Aluminum Middle Blade Base Features Two (2) Aluminum Doors for Wire Management
- Outer Panel of Standard Block Base, Middle Block Base and Standard Blade Base can be Specified in a Contrasting Finish/Color from Top Finish/Color
- Adjustable Glides Included

P = HPL W = Veneer C = Combination of Wood/Laminate

[See One10 Overview For Ordering Options](#)

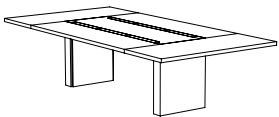
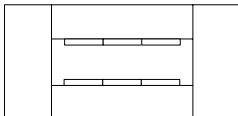
| Item  | Model No.    |   | W   | D  | H  | Ship Wt | Cubic Ft | List Price |  |
|---|--------------|---|-----|----|----|---------|----------|------------|--|
| <b>STANDARD TABLES</b>  |              | <b>60"D Tops</b>                            |     |    |    |         |          |            |  |
|   |              | <i>192"W: 9 Piece Top - 12 Accent Doors</i> |     |    |    |         |          |            |  |
| <b>RECTANGULAR TOP<br/>CENTER INLAY<br/>BLOCK EDGE<br/>BLOCK BASE</b>   | 96-60192RTV5 | HPL   | 192 | 60 | 1½ | 435     | 25.3     | P\$ 15282  |  |
|   | 95-60192RTV5 | Veneer                                      |     |    |    |         |          | W\$ 18061  |  |
|   | 95-60192RTV5 | Veneer/HPL                                  |     |    |    |         |          | C\$ 18325  |  |
|   |              | <i>168"W: 9 Piece Top - 8 Accent Doors</i>  |     |    |    |         |          |            |  |
|                                  | 96-60168RTV5 | HPL   | 168 | 60 | 1½ | 407     | 24.9     | P\$ 13833  |  |
|   | 95-60168RTV5 | Veneer                                      |     |    |    |         |          | W\$ 16055  |  |
|   | 95-60168RTV5 | Veneer/HPL                                  |     |    |    |         |          | C\$ 16475  |  |
|   |              | <i>144"W: 9 Piece Top - 8 Accent Doors</i>  |     |    |    |         |          |            |  |
|                                  | 96-60144RTV5 | HPL   | 144 | 60 | 1½ | 379     | 24.4     | P\$ 13281  |  |
|   | 95-60144RTV5 | Veneer                                      |     |    |    |         |          | W\$ 15243  |  |
|   | 95-60144RTV5 | Veneer/HPL                                  |     |    |    |         |          | C\$ 15632  |  |
|   |              | <i>120"W: 5 Piece Top - 6 Accent Doors</i>  |     |    |    |         |          |            |  |
|   | 96-60120RTV5 | HPL   | 120 | 60 | 1½ | 339     | 24.0     | P\$ 8655   |  |
|   | 95-60120RTV5 | Veneer                                      |     |    |    |         |          | W\$ 10246  |  |
|   | 95-60120RTV5 | Veneer/HPL                                  |     |    |    |         |          | C\$ 10376  |  |
|   |              | <i>108"W: 5 Piece Top - 6 Accent Doors</i>  |     |    |    |         |          |            |  |
| <u>Must Specify (in this order):</u><br>Model #<br>Primary Finish/Color<br>Accent Material<br>Accent Finish/Color | 96-60108RTV5 | HPL   | 108 | 60 | 1½ | 310     | 23.6     | P\$ 8403   |  |
|   | 95-60108RTV5 | Veneer                                      |     |    |    |         |          | W\$ 9890   |  |
|   | 95-60108RTV5 | Veneer/HPL                                  |     |    |    |         |          | C\$ 10006  |  |
|   |              | <i>96"W: 5 Piece Top - 4 Accent Doors</i>   |     |    |    |         |          |            |  |
|   | 96-6096RTV5  | HPL   | 96  | 60 | 1½ | 282     | 23.0     | P\$ 7719   |  |
|   | 95-6096RTV5  | Veneer                                      |     |    |    |         |          | W\$ 9160   |  |
|   | 95-6096RTV5  | Veneer/HPL                                  |     |    |    |         |          | C\$ 9401   |  |
|   |              | <b>48"D Tops</b>                            |     |    |    |         |          |            |  |
|   |              | <i>192"W: 9 Piece Top - 12 Accent Doors</i> |     |    |    |         |          |            |  |
| Rectangular Table<br>With Center Inlay also<br>available with a Knife<br>Edge and coordinating<br>Blade Base.     | 96-48192RTV5 | HPL   | 192 | 48 | 1½ | 345     | 23.9     | P\$ 14175  |  |
|   | 95-48192RTV5 | Veneer                                      |     |    |    |         |          | W\$ 16366  |  |
|   | 95-48192RTV5 | Veneer/HPL                                  |     |    |    |         |          | C\$ 17057  |  |
|   |              | <i>168"W: 9 Piece Top - 8 Accent Doors</i>  |     |    |    |         |          |            |  |
| <a href="#">See Details.</a>  | 96-48168RTV5 | HPL   | 168 | 48 | 1½ | 328     | 23.7     | P\$ 12761  |  |
|   | 95-48168RTV5 | Veneer                                      |     |    |    |         |          | W\$ 14043  |  |
|   | 95-48168RTV5 | Veneer/HPL                                  |     |    |    |         |          | C\$ 14762  |  |
|   |              | <i>144"W: 9 Piece Top - 8 Accent Doors</i>  |     |    |    |         |          |            |  |
|   | 96-48144RTV5 | HPL   | 144 | 48 | 1½ | 311     | 23.4     | P\$ 12287  |  |
|   | 95-48144RTV5 | Veneer                                      |     |    |    |         |          | W\$ 13553  |  |
|   | 95-48144RTV5 | Veneer/HPL                                  |     |    |    |         |          | C\$ 14255  |  |
|   |              | <i>120"W: 5 Piece Top - 6 Accent Doors</i>  |     |    |    |         |          |            |  |
|   | 96-48120RTV5 | HPL   | 120 | 48 | 1½ | 282     | 23.2     | P\$ 7965   |  |
|   | 95-48120RTV5 | Veneer                                      |     |    |    |         |          | W\$ 9083   |  |
|   | 95-48120RTV5 | Veneer/HPL                                  |     |    |    |         |          | C\$ 9457   |  |
|   |              | <i>108"W: 5 Piece Top - 6 Accent Doors</i>  |     |    |    |         |          |            |  |
|   | 96-48108RTV5 | HPL   | 108 | 48 | 1½ | 260     | 22.8     | P\$ 7710   |  |
|   | 95-48108RTV5 | Veneer                                      |     |    |    |         |          | W\$ 8820   |  |
|   | 95-48108RTV5 | Veneer/HPL                                  |     |    |    |         |          | C\$ 9183   |  |
|   |              | <i>96"W: 5 Piece Top - 4 Accent Doors</i>   |     |    |    |         |          |            |  |
|   | 96-4896RTV5  | HPL   | 96  | 48 | 1½ | 237     | 23.0     | P\$ 7076   |  |
|   | 95-4896RTV5  | Veneer                                      |     |    |    |         |          | W\$ 7762   |  |
|   | 95-4896RTV5  | Veneer/HPL                                  |     |    |    |         |          | C\$ 8167   |  |

*Continued on next page.*

P = HPL W = Veneer C = Combination of Wood/Laminate

[See One10 Overview For Ordering Options](#)

| Item | Model No. | W | D | H | Ship Wt | Cubic Ft | List Price |
|------|-----------|---|---|---|---------|----------|------------|
|------|-----------|---|---|---|---------|----------|------------|

Continued from  
Previous Page

**What You Get:**

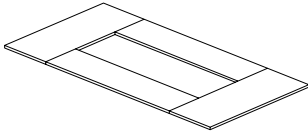

Outer Piece Top

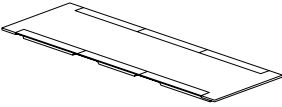

Center Inlay Top

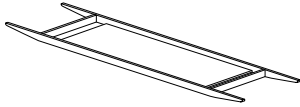

Trough

**Description**

- 1½” Thick Rectangular Top with Block Edge
- Veneer Tops Feature UV Finish
- Center Inlay Includes Aluminum Accent Doors for Wire Management
- Center Inlay Available in Contrasting Laminate or Veneer
- Trough Reinforces and Supports Top
- Requires Two (2) Block Bases; Tables 144”W or Larger Also Require Middle Block Base; Sold Separately, See Below
- Silver Grommet Included for Optional Polycom Installation
- Power and Data Options Available; Sold Separately, [See Multiple Power Unit Details](#); [See Location Options](#)
- Assembly Required

**Top Grain Direction**

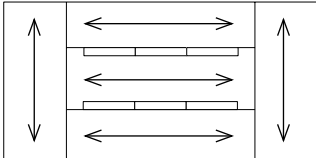

**BLOCK BASES**

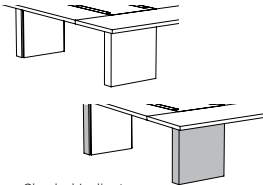

Shaded Indicates  
Accent Area

| <b>Block Base Options; Must Order</b>                        |            |    |    |    |    |     |          |
|--|------------|----|----|----|----|-----|----------|
| <i>Standard Block Base - Two (2) Required</i>                |            |    |    |    |    |     |          |
| 96-2428BB  | HPL        | 24 | 6  | 28 | 52 | 2.4 | P\$ 1483 |
| 95-2428BB  | Veneer     |    |    |    |    |     | W\$ 2036 |
| 95-2428BB  | Veneer/HPL |    |    |    |    |     | C\$ 2280 |
| <i>Middle Block Base - Required for Tops 144”W or Larger</i> |            |    |    |    |    |     |          |
| 96-2428MSL   | HPL        | 24 | 7½ | 28 | 72 | 2.8 | P\$ 1811 |
| 95-2428MSL   | Veneer     |    |    |    |    |     | W\$ 2355 |
| 95-2428MSL   | Veneer/HPL |    |    |    |    |     | C\$ 2682 |

Must Specify (in this order):

- Standard Base Model #
- Primary Finish/Color
- Accent Material
- Accent Finish/Color
- Middle Base Model # (If needed)
- Middle Base Primary Finish/Color
- Middle Base Accent Material
- Middle Base Accent Finish/Color

**Description**

- All Tops Require Two (2) Block Bases; Tables 144”W or Larger Also Require Middle Block Base
- Bases are Constructed with Removable Interior Panel for Wire Management Installation
- Outer Panel can be Specified in Contrasting Finish/Color from Top Finish/Color
- Adjustable Glides Included

P = HPL W = Veneer C = Combination of Wood/Laminate

[See One10 Overview For Ordering Options](#)

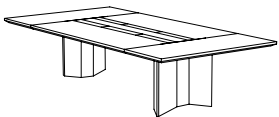
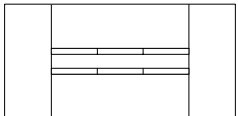
| Item  | Model No.    |   | W   | D  | H      | Ship Wt | Cubic Ft | List Price |  |
|---|--------------|---|-----|----|--------|---------|----------|------------|--|
| <b>STANDARD TABLES</b>  |              | <b>60"D Tops</b>                            |     |    |        |         |          |            |  |
|   |              | <i>192"W: 9 Piece Top - 12 Accent Doors</i> |     |    |        |         |          |            |  |
| <b>RECTANGULAR TOP<br/>CENTER INLAY<br/>KNIFE EDGE<br/>BLADE BASE</b>   | 96-60192RTK5 | HPL   | 192 | 60 | 1 3/16 | 435     | 25.3     | P\$ 17117  |  |
|   | 95-60192RTK5 | Veneer                                      |     |    |        |         |          | W\$ 20227  |  |
|   | 95-60192RTK5 | Veneer/HPL                                  |     |    |        |         |          | C\$ 20571  |  |
|   |              | <i>168"W: 9 Piece Top - 8 Accent Doors</i>  |     |    |        |         |          |            |  |
|                                  | 96-60168RTK5 | HPL   | 168 | 60 | 1 3/16 | 407     | 24.9     | P\$ 15493  |  |
|   | 95-60168RTK5 | Veneer                                      |     |    |        |         |          | W\$ 17982  |  |
|   | 95-60168RTK5 | Veneer/HPL                                  |     |    |        |         |          | C\$ 18469  |  |
|   |              | <i>144"W: 9 Piece Top - 8 Accent Doors</i>  |     |    |        |         |          |            |  |
|                                  | 96-60144RTK5 | HPL   | 144 | 60 | 1 3/16 | 379     | 24.4     | P\$ 14874  |  |
|   | 95-60144RTK5 | Veneer                                      |     |    |        |         |          | W\$ 17074  |  |
|   | 95-60144RTK5 | Veneer/HPL                                  |     |    |        |         |          | C\$ 17529  |  |
|   |              | <i>120"W: 5 Piece Top - 6 Accent Doors</i>  |     |    |        |         |          |            |  |
|   | 96-60120RTK5 | HPL   | 120 | 60 | 1 3/16 | 339     | 24.0     | P\$ 9692   |  |
|   | 95-60120RTK5 | Veneer                                      |     |    |        |         |          | W\$ 11475  |  |
|   | 95-60120RTK5 | Veneer/HPL                                  |     |    |        |         |          | C\$ 11650  |  |
|   |              | <i>108"W: 5 Piece Top - 6 Accent Doors</i>  |     |    |        |         |          |            |  |
| <u>Must Specify (in this order):</u><br>Model #<br>Primary Finish/Color<br>Accent Material<br>Accent Finish/Color | 96-60108RTK5 | HPL   | 108 | 60 | 1 3/16 | 310     | 23.6     | P\$ 9411   |  |
|   | 95-60108RTK5 | Veneer                                      |     |    |        |         |          | W\$ 11074  |  |
|   | 95-60108RTK5 | Veneer/HPL                                  |     |    |        |         |          | C\$ 11234  |  |
|   |              | <i>96"W: 5 Piece Top - 4 Accent Doors</i>   |     |    |        |         |          |            |  |
|   | 96-6096RTK5  | HPL   | 96  | 60 | 1 3/16 | 282     | 23.0     | P\$ 8645   |  |
|   | 95-6096RTK5  | Veneer                                      |     |    |        |         |          | W\$ 10257  |  |
|   | 95-6096RTK5  | Veneer/HPL                                  |     |    |        |         |          | C\$ 10540  |  |
|   |              | <b>48"D Tops</b>                            |     |    |        |         |          |            |  |
|   |              | <i>192"W: 9 Piece Top - 12 Accent Doors</i> |     |    |        |         |          |            |  |
| Rectangular Table<br>With Center Inlay also<br>available with a Block<br>Edge and coordinating<br>Block Base.     | 96-48192RTK5 | HPL   | 192 | 48 | 1 3/16 | 345     | 23.9     | P\$ 15877  |  |
|   | 95-48192RTK5 | Veneer                                      |     |    |        |         |          | W\$ 18328  |  |
|   | 95-48192RTK5 | Veneer/HPL                                  |     |    |        |         |          | C\$ 19091  |  |
|   |              | <i>168"W: 9 Piece Top - 8 Accent Doors</i>  |     |    |        |         |          |            |  |
|   | 96-48168RTK5 | HPL   | 168 | 48 | 1 3/16 | 328     | 23.7     | P\$ 14293  |  |
|   | 95-48168RTK5 | Veneer                                      |     |    |        |         |          | W\$ 15728  |  |
|   | 95-48168RTK5 | Veneer/HPL                                  |     |    |        |         |          | C\$ 16506  |  |
|   |              | <i>144"W: 9 Piece Top - 8 Accent Doors</i>  |     |    |        |         |          |            |  |
|   | 96-48144RTK5 | HPL   | 144 | 48 | 1 3/16 | 311     | 23.4     | P\$ 13765  |  |
|   | 95-48144RTK5 | Veneer                                      |     |    |        |         |          | W\$ 15179  |  |
|   | 95-48144RTK5 | Veneer/HPL                                  |     |    |        |         |          | C\$ 15941  |  |
|   |              | <i>120"W: 5 Piece Top - 6 Accent Doors</i>  |     |    |        |         |          |            |  |
| <a href="#">See Details.</a>  | 96-48120RTK5 | HPL   | 120 | 48 | 1 3/16 | 282     | 23.2     | P\$ 8921   |  |
|   | 95-48120RTK5 | Veneer                                      |     |    |        |         |          | W\$ 10173  |  |
|   | 95-48120RTK5 | Veneer/HPL                                  |     |    |        |         |          | C\$ 10589  |  |
|   |              | <i>108"W: 5 Piece Top - 6 Accent Doors</i>  |     |    |        |         |          |            |  |
|   | 96-48108RTK5 | HPL   | 108 | 48 | 1 3/16 | 260     | 22.8     | P\$ 8634   |  |
|   | 95-48108RTK5 | Veneer                                      |     |    |        |         |          | W\$ 9878   |  |
|   | 95-48108RTK5 | Veneer/HPL                                  |     |    |        |         |          | C\$ 10278  |  |
|   |              | <i>96"W: 5 Piece Top - 4 Accent Doors</i>   |     |    |        |         |          |            |  |
|   | 96-4896RTK5  | HPL   | 96  | 48 | 1 3/16 | 237     | 23.0     | P\$ 7926   |  |
|   | 95-4896RTK5  | Veneer                                      |     |    |        |         |          | W\$ 8695   |  |
|   | 95-4896RTK5  | Veneer/HPL                                  |     |    |        |         |          | C\$ 9130   |  |

*Continued on next page.*

P = HPL W = Veneer C = Combination of Wood/Laminate

[See One10 Overview For Ordering Options](#)



| Item | Model No. | W | D | H | Ship Wt | Cubic Ft | List Price |
|------|-----------|---|---|---|---------|----------|------------|
|------|-----------|---|---|---|---------|----------|------------|

Continued from  
Previous Page

**What You Get:**

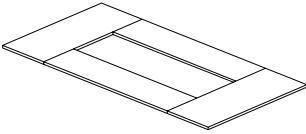

Outer Piece Top

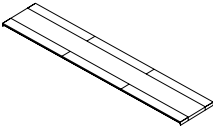

Center Inlay Top

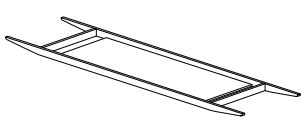

Trough

**Description**

- 1 $\frac{3}{16}$ " Rectangular Top with Knife Edge
- Veneer Tops Feature UV Finish
- Center Inlay Includes Aluminum Accent Doors for Wire Management
- Center Inlay Available in Contrasting Laminate or Veneer
- Trough Reinforces and Supports Top
- Requires Two (2) Blade Bases; Tables 144"W or Larger Also Require Middle Blade Base; Sold Separately, See Below
- Silver Grommet Included for Optional Polycrom Installation
- Power and Data Options Available; Sold Separately, [See Multiple Power Unit Details](#); [See Location Options](#)
- Assembly Required

**Top Grain Direction**

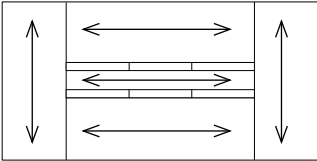

**BLADE BASES**

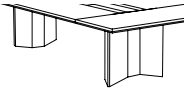

| Blade Base Options; Must Order                               |          |    |                  |    |    |     |     |      |
|--|----------|----|------------------|----|----|-----|-----|------|
| <i>Standard Blade Base - Two (2) Required</i>                |          |    |                  |    |    |     |     |      |
| 96-2828BD  | HPL      | 28 | 10 $\frac{1}{2}$ | 28 | 52 | 2.4 | P\$ | 1210 |
| 95-2828BD  | Veneer   |    |                  |    |    |     | W\$ | 1666 |
| <i>Middle Blade Base - Required for Tops 144"W or Larger</i> |          |    |                  |    |    |     |     |      |
| 96-2818MBD   | Aluminum | 18 | 3 $\frac{3}{8}$  | 28 | 72 | 2.8 | \$  | 1602 |
| 95-2818MBD   | Aluminum |    |                  |    |    |     | \$  | 1602 |

**Description**

- All Tops Require Two (2) Blade Bases; Tables 144"W or Larger Also Require Middle Blade Base
- Bases are Constructed with Removable Interior Aluminum Panel for Wire Management Installation
- Aluminum Middle Blade Base Features Two (2) Aluminum Doors for Wire Management
- Outer Panel of Standard Blade Base can be Specified in a Contrasting Finish/Color from Top Finish/Color
- Adjustable Glides Included

Must Specify (in this order):

- Standard Base Model #
- Primary Finish/Color
- Middle Base Model # (If needed)

P = HPL W = Veneer C = Combination of Wood/Laminate

[See One10 Overview For Ordering Options](#)

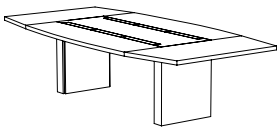
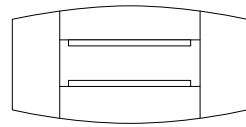
| Item  | Model No.    |   | W   | D       | H  | Ship Wt | Cubic Ft | List Price |  |
|---|--------------|---|-----|---------|----|---------|----------|------------|--|
| <b>STANDARD TABLES</b>  |              | <b>60"D Tops</b>                            |     |         |    |         |          |            |  |
|   |              | <i>192"W: 9 Piece Top - 12 Accent Doors</i> |     |         |    |         |          |            |  |
| <b>BOAT-SHAPED TOP<br/>CENTER INLAY<br/>BLOCK EDGE<br/>BLOCK BASE</b>   | 96-60192BTV5 | HPL   | 192 | 60 - 48 | 1½ | 435     | 25.3     | P\$ 16044  |  |
|   | 95-60192BTV5 | Veneer                                      |     |         |    |         |          | W\$ 18962  |  |
|   | 95-60192BTV5 | Veneer/HPL                                  |     |         |    |         |          | C\$ 19241  |  |
|   |              | <i>168"W: 9 Piece Top - 8 Accent Doors</i>  |     |         |    |         |          |            |  |
|                                  | 96-60168BTV5 | HPL   | 168 | 60 - 48 | 1½ | 407     | 24.9     | P\$ 14526  |  |
|   | 95-60168BTV5 | Veneer                                      |     |         |    |         |          | W\$ 16858  |  |
|   | 95-60168BTV5 | Veneer/HPL                                  |     |         |    |         |          | C\$ 17297  |  |
|   |              | <i>144"W: 9 Piece Top - 8 Accent Doors</i>  |     |         |    |         |          |            |  |
|                                  | 96-60144BTV5 | HPL   | 144 | 60 - 48 | 1½ | 379     | 24.4     | P\$ 13946  |  |
|   | 95-60144BTV5 | Veneer                                      |     |         |    |         |          | W\$ 16005  |  |
|   | 95-60144BTV5 | Veneer/HPL                                  |     |         |    |         |          | C\$ 16414  |  |
|   |              | <i>120"W: 5 Piece Top - 6 Accent Doors</i>  |     |         |    |         |          |            |  |
|   | 96-60120BTV5 | HPL   | 120 | 60 - 48 | 1½ | 339     | 24.0     | P\$ 9088   |  |
|   | 95-60120BTV5 | Veneer                                      |     |         |    |         |          | W\$ 10758  |  |
|   | 95-60120BTV5 | Veneer/HPL                                  |     |         |    |         |          | C\$ 10896  |  |
|   |              | <i>108"W: 5 Piece Top - 6 Accent Doors</i>  |     |         |    |         |          |            |  |
| <u>Must Specify (in this order):</u><br>Model #<br>Primary Finish/Color<br>Accent Material<br>Accent Finish/Color | 96-60108BTV5 | HPL   | 108 | 60 - 48 | 1½ | 310     | 23.6     | P\$ 8824   |  |
|   | 95-60108BTV5 | Veneer                                      |     |         |    |         |          | W\$ 10385  |  |
|   | 95-60108BTV5 | Veneer/HPL                                  |     |         |    |         |          | C\$ 10507  |  |
|   |              | <i>96"W: 5 Piece Top - 4 Accent Doors</i>   |     |         |    |         |          |            |  |
|   | 96-6096BTV5  | HPL   | 96  | 60 - 48 | 1½ | 282     | 23.0     | P\$ 8105   |  |
|   | 95-6096BTV5  | Veneer                                      |     |         |    |         |          | W\$ 9617   |  |
|   | 95-6096BTV5  | Veneer/HPL                                  |     |         |    |         |          | C\$ 9870   |  |
|   |              | <b>48"D Tops</b>                            |     |         |    |         |          |            |  |
|   |              | <i>192"W: 9 Piece Top - 12 Accent Doors</i> |     |         |    |         |          |            |  |
| Boat-Shaped Table<br>With Center Inlay also<br>available with a Knife<br>Edge and coordinating<br>Blade Base.     | 96-48192BTV5 | HPL   | 192 | 48 - 36 | 1½ | 345     | 23.9     | P\$ 14887  |  |
|   | 95-48192BTV5 | Veneer                                      |     |         |    |         |          | W\$ 17182  |  |
|   | 95-48192BTV5 | Veneer/HPL                                  |     |         |    |         |          | C\$ 17908  |  |
|   |              | <i>168"W: 9 Piece Top - 8 Accent Doors</i>  |     |         |    |         |          |            |  |
| <a href="#">See Details.</a>  | 96-48168BTV5 | HPL   | 168 | 48 - 36 | 1½ | 328     | 23.7     | P\$ 13399  |  |
|   | 95-48168BTV5 | Veneer                                      |     |         |    |         |          | W\$ 14743  |  |
|   | 95-48168BTV5 | Veneer/HPL                                  |     |         |    |         |          | C\$ 15499  |  |
|   |              | <i>144"W: 9 Piece Top - 8 Accent Doors</i>  |     |         |    |         |          |            |  |
|   | 96-48144BTV5 | HPL   | 144 | 48 - 36 | 1½ | 311     | 23.4     | P\$ 12904  |  |
|   | 95-48144BTV5 | Veneer                                      |     |         |    |         |          | W\$ 14229  |  |
|   | 95-48144BTV5 | Veneer/HPL                                  |     |         |    |         |          | C\$ 14968  |  |
|   |              | <i>120"W: 5 Piece Top - 6 Accent Doors</i>  |     |         |    |         |          |            |  |
|   | 96-48120BTV5 | HPL   | 120 | 48 - 36 | 1½ | 282     | 23.2     | P\$ 8363   |  |
|   | 95-48120BTV5 | Veneer                                      |     |         |    |         |          | W\$ 9537   |  |
|   | 95-48120BTV5 | Veneer/HPL                                  |     |         |    |         |          | C\$ 9931   |  |
|   |              | <i>108"W: 5 Piece Top - 6 Accent Doors</i>  |     |         |    |         |          |            |  |
|   | 96-48108BTV5 | HPL   | 108 | 48 - 36 | 1½ | 260     | 22.8     | P\$ 8096   |  |
|   | 95-48108BTV5 | Veneer                                      |     |         |    |         |          | W\$ 9260   |  |
|   | 95-48108BTV5 | Veneer/HPL                                  |     |         |    |         |          | C\$ 9644   |  |
|   |              | <i>96"W: 5 Piece Top - 4 Accent Doors</i>   |     |         |    |         |          |            |  |
|   | 96-4896BTV5  | HPL   | 96  | 48 - 36 | 1½ | 237     | 23.0     | P\$ 7431   |  |
|   | 95-4896BTV5  | Veneer                                      |     |         |    |         |          | W\$ 8153   |  |
|   | 95-4896BTV5  | Veneer/HPL                                  |     |         |    |         |          | C\$ 8575   |  |

*Continued on next page.*

P = HPL W = Veneer C = Combination of Wood/Laminate

[See One10 Overview For Ordering Options](#)

| Item | Model No. | W | D | H | Ship Wt | Cubic Ft | List Price |
|------|-----------|---|---|---|---------|----------|------------|
|------|-----------|---|---|---|---------|----------|------------|

Continued from  
Previous Page

**What You Get:**

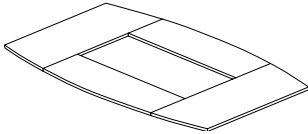

Outer Piece Top

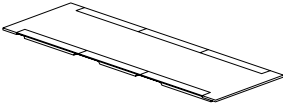

Center Inlay Top

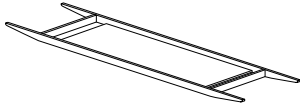

Trough

**Description**

- 1½” Thick Boat-Shaped Top with Block Edge
- Veneer Tops Feature UV Finish
- Center Inlay Includes Aluminum Accent Doors for Wire Management
- Center Inlay Available in Contrasting Laminate or Veneer
- Trough Reinforces and Supports Top
- Requires Two (2) Block Bases; Tables 144”W or Larger Also Require Middle Block Base; Sold Separately, See Below
- Silver Grommet Included for Optional Polycom Installation
- Power and Data Options Available; Sold Separately, [See Multiple Power Unit Details](#); [See Location Options](#)
- Assembly Required

**Top Grain Direction**

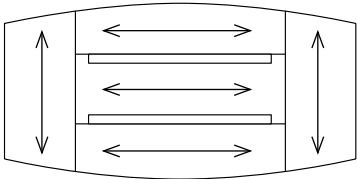

**BLOCK BASES**

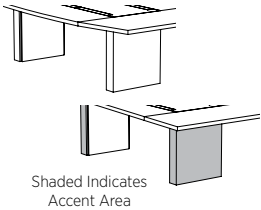

| <b>Block Base Options; Must Order</b>                        |            |    |    |    |    |     |          |
|--|------------|----|----|----|----|-----|----------|
| <i>Standard Block Base - Two (2) Required</i>                |            |    |    |    |    |     |          |
| 96-2428BB  | HPL        | 24 | 6  | 28 | 52 | 2.4 | P\$ 1483 |
| 95-2428BB  | Veneer     |    |    |    |    |     | W\$ 2036 |
| 95-2428BB  | Veneer/HPL |    |    |    |    |     | C\$ 2280 |
| <i>Middle Block Base - Required for Tops 144”W or Larger</i> |            |    |    |    |    |     |          |
| 96-2428MSL   | HPL        | 24 | 7½ | 28 | 72 | 2.8 | P\$ 1811 |
| 95-2428MSL   | Veneer     |    |    |    |    |     | W\$ 2355 |
| 95-2428MSL   | Veneer/HPL |    |    |    |    |     | C\$ 2682 |

Must Specify (in this order):

- Standard Base Model #
- Primary Finish/Color
- Accent Material
- Accent Finish/Color
- Middle Base Model # (If needed)
- Middle Base Primary Finish/Color
- Middle Base Accent Material
- Middle Base Accent Finish/Color

**Description**

- All Tops Require Two (2) Block Bases; Tables 144”W or Larger Also Require Middle Block Base
- Bases are Constructed with Removable Interior Panel for Wire Management Installation
- Outer Panel can be Specified in a Contrasting Finish/Color from Top Finish/Color
- Adjustable Glides Included

P = HPL W = Veneer C = Combination of Wood/Laminate

[See One10 Overview For Ordering Options](#)

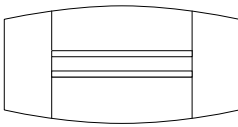
| Item  | Model No.    |   | W   | D       | H      | Ship Wt | Cubic Ft | List Price |  |
|---|--------------|---|-----|---------|--------|---------|----------|------------|--|
| <b>STANDARD TABLES</b>  |              | <b>60"D Tops</b>                            |     |         |        |         |          |            |  |
|   |              | <i>192"W: 9 Piece Top - 12 Accent Doors</i> |     |         |        |         |          |            |  |
| <b>BOAT-SHAPED TOP<br/>CENTER INLAY<br/>KNIFE EDGE<br/>BLADE BASE</b>   | 96-60192BTK5 | HPL   | 192 | 60 - 48 | 1 3/16 | 435     | 25.3     | P\$ 17971  |  |
|   | 95-60192BTK5 | Veneer                                      |     |         |        |         |          | W\$ 21237  |  |
|   | 95-60192BTK5 | Veneer/HPL                                  |     |         |        |         |          | C\$ 21597  |  |
|   |              | <i>168"W: 9 Piece Top - 8 Accent Doors</i>  |     |         |        |         |          |            |  |
|                                  | 96-60168BTK5 | HPL   | 168 | 60 - 48 | 1 3/16 | 407     | 24.9     | P\$ 16267  |  |
|   | 95-60168BTK5 | Veneer                                      |     |         |        |         |          | W\$ 18881  |  |
|   | 95-60168BTK5 | Veneer/HPL                                  |     |         |        |         |          | C\$ 19393  |  |
|   |              | <i>144"W: 9 Piece Top - 8 Accent Doors</i>  |     |         |        |         |          |            |  |
|                                  | 96-60144BTK5 | HPL   | 144 | 60 - 48 | 1 3/16 | 379     | 24.4     | P\$ 15618  |  |
|   | 95-60144BTK5 | Veneer                                      |     |         |        |         |          | W\$ 17927  |  |
|   | 95-60144BTK5 | Veneer/HPL                                  |     |         |        |         |          | C\$ 18407  |  |
|   |              | <i>120"W: 5 Piece Top - 6 Accent Doors</i>  |     |         |        |         |          |            |  |
|   | 96-60120BTK5 | HPL   | 120 | 60 - 48 | 1 3/16 | 339     | 24.0     | P\$ 10178  |  |
|   | 95-60120BTK5 | Veneer                                      |     |         |        |         |          | W\$ 12048  |  |
|   | 95-60120BTK5 | Veneer/HPL                                  |     |         |        |         |          | C\$ 12233  |  |
|   |              | <i>108"W: 5 Piece Top - 6 Accent Doors</i>  |     |         |        |         |          |            |  |
| <u>Must Specify (in this order):</u><br>Model #<br>Primary Finish/Color<br>Accent Material<br>Accent Finish/Color | 96-60108BTK5 | HPL   | 108 | 60 - 48 | 1 3/16 | 310     | 23.6     | P\$ 9883   |  |
|   | 95-60108BTK5 | Veneer                                      |     |         |        |         |          | W\$ 11630  |  |
|   | 95-60108BTK5 | Veneer/HPL                                  |     |         |        |         |          | C\$ 11797  |  |
|   |              | <i>96"W: 5 Piece Top - 4 Accent Doors</i>   |     |         |        |         |          |            |  |
|   | 96-6096BTK5  | HPL   | 96  | 60 - 48 | 1 3/16 | 282     | 23.0     | P\$ 9079   |  |
|   | 95-6096BTK5  | Veneer                                      |     |         |        |         |          | W\$ 10771  |  |
|   | 95-6096BTK5  | Veneer/HPL                                  |     |         |        |         |          | C\$ 11066  |  |
|   |              | <b>48"D Tops</b>                            |     |         |        |         |          |            |  |
|   |              | <i>192"W: 9 Piece Top - 12 Accent Doors</i> |     |         |        |         |          |            |  |
| Boat-Shaped Table<br>With Center Inlay also<br>available with a Block<br>Edge and coordinating<br>Block Base.     | 96-48192BTK5 | HPL   | 192 | 48 - 36 | 1 3/16 | 345     | 23.9     | P\$ 16674  |  |
|   | 95-48192BTK5 | Veneer                                      |     |         |        |         |          | W\$ 19247  |  |
|   | 95-48192BTK5 | Veneer/HPL                                  |     |         |        |         |          | C\$ 20047  |  |
|   |              | <i>168"W: 9 Piece Top - 8 Accent Doors</i>  |     |         |        |         |          |            |  |
| <a href="#">See Details.</a>  | 96-48168BTK5 | HPL   | 168 | 48 - 36 | 1 3/16 | 328     | 23.7     | P\$ 15007  |  |
|   | 95-48168BTK5 | Veneer                                      |     |         |        |         |          | W\$ 16514  |  |
|   | 95-48168BTK5 | Veneer/HPL                                  |     |         |        |         |          | C\$ 17329  |  |
|   |              | <i>144"W: 9 Piece Top - 8 Accent Doors</i>  |     |         |        |         |          |            |  |
|   | 96-48144BTK5 | HPL   | 144 | 48 - 36 | 1 3/16 | 311     | 23.4     | P\$ 14450  |  |
|   | 95-48144BTK5 | Veneer                                      |     |         |        |         |          | W\$ 15941  |  |
|   | 95-48144BTK5 | Veneer/HPL                                  |     |         |        |         |          | C\$ 16739  |  |
|   |              | <i>120"W: 5 Piece Top - 6 Accent Doors</i>  |     |         |        |         |          |            |  |
|   | 96-48120BTK5 | HPL   | 120 | 48 - 36 | 1 3/16 | 282     | 23.2     | P\$ 9368   |  |
|   | 95-48120BTK5 | Veneer                                      |     |         |        |         |          | W\$ 10682  |  |
|   | 95-48120BTK5 | Veneer/HPL                                  |     |         |        |         |          | C\$ 11119  |  |
|   |              | <i>108"W: 5 Piece Top - 6 Accent Doors</i>  |     |         |        |         |          |            |  |
|   | 96-48108BTK5 | HPL   | 108 | 48 - 36 | 1 3/16 | 260     | 22.8     | P\$ 9068   |  |
|   | 95-48108BTK5 | Veneer                                      |     |         |        |         |          | W\$ 10371  |  |
|   | 95-48108BTK5 | Veneer/HPL                                  |     |         |        |         |          | C\$ 10794  |  |
|   |              | <i>96"W: 5 Piece Top - 4 Accent Doors</i>   |     |         |        |         |          |            |  |
|   | 96-4896BTK5  | HPL   | 96  | 48 - 36 | 1 3/16 | 237     | 23.0     | P\$ 8320   |  |
|   | 95-4896BTK5  | Veneer                                      |     |         |        |         |          | W\$ 9128   |  |
|   | 95-4896BTK5  | Veneer/HPL                                  |     |         |        |         |          | C\$ 9585   |  |

*Continued on next page.*

P = HPL W = Veneer C = Combination of Wood/Laminate

[See One10 Overview For Ordering Options](#)

| Item | Model No. | W | D | H | Ship Wt | Cubic Ft | List Price |
|------|-----------|---|---|---|---------|----------|------------|
|------|-----------|---|---|---|---------|----------|------------|

Continued from  
Previous Page

**What You Get:**

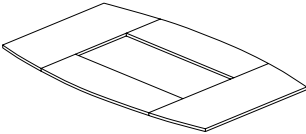

Outer Piece Top

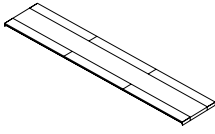

Center Inlay Top

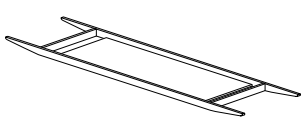

Trough

**Description**

- 1 $\frac{3}{16}$ " Boat-Shaped Top with Knife Edge
- Veneer Tops Feature UV Finish
- Center Inlay Includes Aluminum Accent Doors for Wire Management
- Center Inlay Available in Contrasting Laminate or Veneer
- Trough Reinforces and Supports Top
- Requires Two (2) Blade Bases; Tables 144"W or Larger Also Require Middle Blade Base; Sold Separately, See Below
- Silver Grommet Included for Optional Polycrom Installation
- Power and Data Options Available; Sold Separately, [See Multiple Power Unit Details](#); [See Location Options](#)
- Assembly Required

**Top Grain Direction**

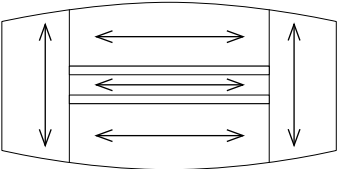

**BLADE BASES**

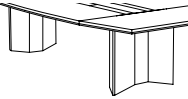

| <b>Blade Base Options; Must Order</b>                        |          |    |                  |    |    |     |          |
|--|----------|----|------------------|----|----|-----|----------|
| <i>Standard Blade Base - Two (2) Required</i>                |          |    |                  |    |    |     |          |
| 96-2828BD  | HPL      | 28 | 10 $\frac{1}{2}$ | 28 | 52 | 2.4 | P\$ 1210 |
| 95-2828BD  | Veneer   |    |                  |    |    |     | W\$ 1666 |
| <i>Middle Blade Base - Required for Tops 144"W or Larger</i> |          |    |                  |    |    |     |          |
| 96-2818MBD   | Aluminum | 18 | 3 $\frac{7}{8}$  | 28 | 72 | 2.8 | \$ 1602  |
| 95-2818MBD   | Aluminum |    |                  |    |    |     | \$ 1602  |



**Description**

- All Tops Require Two (2) Blade Bases; Tables 144"W or Larger Also Require Middle Blade Base
- Bases are Constructed with Removable Aluminum Interior Panel for Wire Management Installation
- Aluminum Middle Blade Base Features Two (2) Aluminum Doors for Wire Management
- Outer Panel of Standard Blade Base can be Specified in a Contrasting Finish/Color from Top Finish/Color
- Adjustable Glides Included

Must Specify (in this order):  
Standard Base Model #  
Primary Finish/Color  
Middle Base Model # (If needed)

P = HPL W = Veneer C = Combination of Wood/Laminate

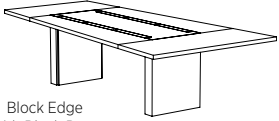
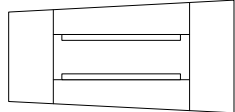
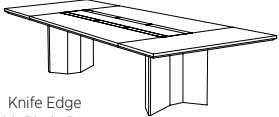
[See One10 Overview For Ordering Options](#)

| Item   | Model No.                                  |            | W       | D       | H   | Ship Wt | Cubic Ft  | List Price |  |
|--|--|------------|---------|---------|-----|---------|-----------|------------|--|
| <b>STANDARD TABLES</b>   |  |            |         |         |     |         |           |            |  |
| <b>Block Edge (Use with Block Base Only)</b>   |  |            |         |         |     |         |           |            |  |
| <i>192"W: 9 Piece Top - 12 Accent Doors</i>  |  |            |         |         |     |         |           |            |  |
| <b>VIEW-SHAPED TOP<br/>CENTER INLAY<br/>BLOCK EDGE W/BLOCK BASE<br/>OR KNIFE EDGE W/BLADE BASE</b><br><br><br>Block Edge with Block Base<br><br><br><br><br>Knife Edge with Blade Base<br><br> | 96-60192VTV5                               | HPL        | 192     | 60 - 48 | 1½  | 435     | 25.3      | P\$ 16044  |  |
|  | 95-60192VTV5                               | Veneer     |         |         |     |         |           | W\$ 18962  |  |
|  | 95-60192VTV5                               | Veneer/HPL |         |         |     |         |           | C\$ 19241  |  |
|  | <i>168"W: 9 Piece Top - 8 Accent Doors</i> |            |         |         |     |         |           |            |  |
|  | 96-60168VTV5                               | HPL        | 168     | 60 - 48 | 1½  | 407     | 24.9      | P\$ 14526  |  |
|  | 95-60168VTV5                               | Veneer     |         |         |     |         |           | W\$ 16858  |  |
|  | 95-60168VTV5                               | Veneer/HPL |         |         |     |         |           | C\$ 17297  |  |
|  | <i>144"W: 9 Piece Top - 8 Accent Doors</i> |            |         |         |     |         |           |            |  |
|  | 96-60144VTV5                               | HPL        | 144     | 60 - 48 | 1½  | 379     | 24.4      | P\$ 13946  |  |
| 95-60144VTV5   | Veneer                                     |            |         |         |     |         | W\$ 16005 |            |  |
| 95-60144VTV5   | Veneer/HPL                                 |            |         |         |     |         | C\$ 16414 |            |  |
| <i>120"W: 5 Piece Top - 6 Accent Doors</i>   |  |            |         |         |     |         |           |            |  |
| 96-60120VTV5   | HPL  | 120        | 60 - 48 | 1½      | 339 | 24.0    | P\$ 9088  |            |  |
| 95-60120VTV5   | Veneer                                     |            |         |         |     |         | W\$ 10758 |            |  |
| 95-60120VTV5   | Veneer/HPL                                 |            |         |         |     |         | C\$ 10896 |            |  |
| <i>108"W: 5 Piece Top - 6 Accent Doors</i>   |  |            |         |         |     |         |           |            |  |
| 96-60108VTV5   | HPL  | 108        | 60 - 48 | 1½      | 310 | 23.6    | P\$ 8824  |            |  |
| 95-60108VTV5   | Veneer                                     |            |         |         |     |         | W\$ 10385 |            |  |
| 95-60108VTV5   | Veneer/HPL                                 |            |         |         |     |         | C\$ 10507 |            |  |
| <i>96"W: 5 Piece Top - 4 Accent Doors</i>  |  |            |         |         |     |         |           |            |  |
| 96-6096VTV5  | HPL  | 96         | 60 - 48 | 1½      | 282 | 23.0    | P\$ 8105  |            |  |
| 95-6096VTV5  | Veneer                                     |            |         |         |     |         | W\$ 9617  |            |  |
| 95-6096VTV5  | Veneer/HPL                                 |            |         |         |     |         | C\$ 9870  |            |  |
| <b>Knife Edge (Use with Blade Base Only)</b>   |  |            |         |         |     |         |           |            |  |
| <i>192"W: 9 Piece Top - 12 Accent Doors</i>  |  |            |         |         |     |         |           |            |  |
| 96-60192VTK5   | HPL  | 192        | 60 - 48 | 1⅜      | 435 | 25.3    | P\$ 17971 |            |  |
| 95-60192VTK5   | Veneer                                     |            |         |         |     |         | W\$ 21237 |            |  |
| 95-60192VTK5   | Veneer/HPL                                 |            |         |         |     |         | C\$ 21597 |            |  |
| <i>168"W: 9 Piece Top - 8 Accent Doors</i>   |  |            |         |         |     |         |           |            |  |
| 96-60168VTK5   | HPL  | 168        | 60 - 48 | 1⅜      | 407 | 24.9    | P\$ 16267 |            |  |
| 95-60168VTK5   | Veneer                                     |            |         |         |     |         | W\$ 18881 |            |  |
| 95-60168VTK5   | Veneer/HPL                                 |            |         |         |     |         | C\$ 19393 |            |  |
| <i>144"W: 9 Piece Top - 8 Accent Doors</i>   |  |            |         |         |     |         |           |            |  |
| 96-60144VTK5   | HPL  | 144        | 60 - 48 | 1⅜      | 379 | 24.4    | P\$ 15618 |            |  |
| 95-60144VTK5   | Veneer                                     |            |         |         |     |         | W\$ 17927 |            |  |
| 95-60144VTK5   | Veneer/HPL                                 |            |         |         |     |         | C\$ 18407 |            |  |
| <i>120"W: 5 Piece Top - 6 Accent Doors</i>   |  |            |         |         |     |         |           |            |  |
| 96-60120VTK5   | HPL  | 120        | 60 - 48 | 1⅜      | 339 | 24.0    | P\$ 10178 |            |  |
| 95-60120VTK5   | Veneer                                     |            |         |         |     |         | W\$ 12048 |            |  |
| 95-60120VTK5   | Veneer/HPL                                 |            |         |         |     |         | C\$ 12233 |            |  |
| <i>108"W: 5 Piece Top - 6 Accent Doors</i>   |  |            |         |         |     |         |           |            |  |
| 96-60108VTK5   | HPL  | 108        | 60 - 48 | 1⅜      | 310 | 23.6    | P\$ 9883  |            |  |
| 95-60108VTK5   | Veneer                                     |            |         |         |     |         | W\$ 11630 |            |  |
| 95-60108VTK5   | Veneer/HPL                                 |            |         |         |     |         | C\$ 11797 |            |  |
| <i>96"W: 5 Piece Top - 4 Accent Doors</i>  |  |            |         |         |     |         |           |            |  |
| 96-6096VTK5  | HPL  | 96         | 60 - 48 | 1⅜      | 282 | 23.0    | P\$ 9079  |            |  |
| 95-6096VTK5  | Veneer                                     |            |         |         |     |         | W\$ 10771 |            |  |
| 95-6096VTK5  | Veneer/HPL                                 |            |         |         |     |         | C\$ 11066 |            |  |

Must Specify (in this order):

- Model #
- Primary Finish/Color
- Accent Material
- Accent Finish/Color

*Continued on next page.*

P = HPL W = Veneer C = Combination of Wood/Laminate

[See One10 Overview For Ordering Options](#)

| Item | Model No. | W | D | H | Ship Wt | Cubic Ft | List Price |
|------|-----------|---|---|---|---------|----------|------------|
|------|-----------|---|---|---|---------|----------|------------|

Continued from  
Previous Page

**What You Get:**

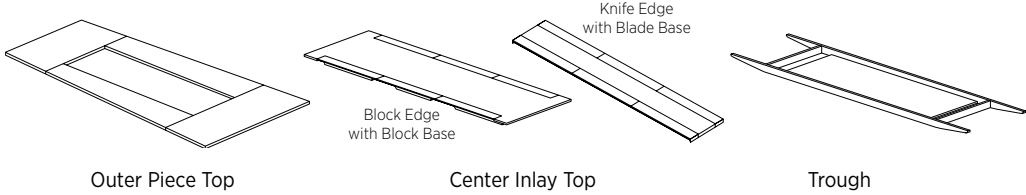

**Description**

- 1½" Thick View-Shaped Top with Block Edge or 1⅜" Thick View-Shaped Top with Knife Edge
- Veneer Tops Feature UV Finish
- Center Inlay Includes Aluminum Accent Doors for Wire Management
- Center Inlay Available in Contrasting Laminate or Veneer
- Trough Reinforces and Supports Top
- Requires Two (2) Block Bases (Block Edge) or Two (2) Blade Bases (Knife Edge); Tables 144"W or Larger Also Require Middle Base; Sold Separately, See Below
- Silver Grommet Included for Optional Polycorn Installation
- Power and Data Options Available; Sold Separately, [See Multiple Power Unit Details](#); [See Locations Options](#)
- Assembly Required

**Top Grain Direction**

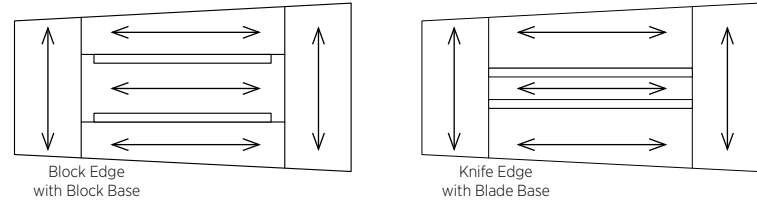

**BLOCK & BLADE BASES**

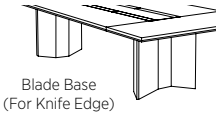
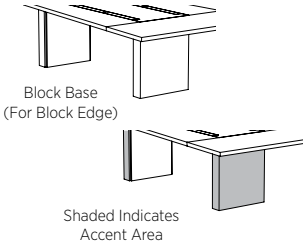

**Block Base Options (For Block Edge Top Only); Must Order**

| <i>Standard Block Base - Two (2) Required</i>                |            |    |    |    |    |     |          |
|--|------------|----|----|----|----|-----|----------|
| 96-2428BB  | HPL        | 24 | 6  | 28 | 52 | 2.4 | P\$ 1483 |
| 95-2428BB  | Veneer     |    |    |    |    |     | W\$ 2036 |
| 95-2428BB  | Veneer/HPL |    |    |    |    |     | C\$ 2280 |
| <i>Middle Block Base - Required for Tops 144"W or Larger</i> |            |    |    |    |    |     |          |
| 96-2428MSL   | HPL        | 24 | 7½ | 28 | 72 | 2.8 | P\$ 1811 |
| 95-2428MSL   | Veneer     |    |    |    |    |     | W\$ 2355 |
| 95-2428MSL   | Veneer/HPL |    |    |    |    |     | C\$ 2682 |

**Blade Base Options (For Knife Edge Top Only); Must Order**

| <i>Standard Blade Base - Two (2) Required</i>                |          |    |     |    |    |     |          |
|--|----------|----|-----|----|----|-----|----------|
| 96-2828BD  | HPL      | 28 | 10½ | 28 | 52 | 2.4 | P\$ 1210 |
| 95-2828BD  | Veneer   |    |     |    |    |     | W\$ 1666 |
| <i>Middle Blade Base - Required for Tops 144"W or Larger</i> |          |    |     |    |    |     |          |
| 96-2818MBD   | Aluminum | 18 | 3⅝  | 28 | 72 | 2.8 | \$ 1602  |
| 95-2818MBD   | Aluminum |    |     |    |    |     | \$ 1602  |

Must Specify (in this order):

- Standard Base Model #
- Primary Finish/Color
- Accent Material (Block)
- Accent Finish/Color (Block)
- Middle Base Model # (If needed)
- Middle Base Primary Finish/Color (Block)
- Middle Base Accent Material (Block)
- Middle Base Accent Finish/Color (Block)

**Description**

- All Tops Require Two (2) Bases; Tables 144"W or Larger Also Require Middle Base
- Bases are Constructed with Removable Interior Panel (Aluminum Interior Panel on Blade Bases) for Wire Management Installation
- Outer Panel can be Specified in a Contrasting Finish/Color from Top Finish/Color
- Adjustable Glides Included

P = HPL W = Veneer C = Combination of Wood/Laminate

[See One10 Overview For Ordering Options](#)

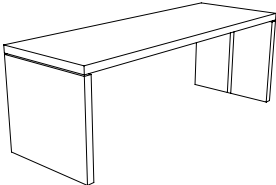
| Item   | Model No.              |        | W  | D   | H   | Ship Wt | Cubic Ft  | List Price |
|--|------------------------|--------|----|-----|-----|---------|-----------|------------|
| <b>PARSONS TABLES</b><br><b>SOLID TOP</b><br> | <b>Standing Height</b> |        |    |     |     |         |           |            |
|  | 96-36120TPT            | HPL    | 36 | 120 | 42  | 402     | 41.1      | P\$ 11922  |
|  | 95-36120TPT            | Veneer |    |     |     |         |           | W\$ 11884  |
|  | 96-3696TPT             | HPL    | 36 | 96  | 42  | 393     | 37.7      | P\$ 11565  |
|  | 95-3696TPT             | Veneer |    |     |     |         |           | W\$ 11245  |
|  | 96-3672TPT             | HPL    | 36 | 72  | 42  | 385     | 34.3      | P\$ 10472  |
|  | 95-3672TPT             | Veneer |    |     |     |         |           | W\$ 10407  |
|  | <b>Counter Height</b>  |        |    |     |     |         |           |            |
|  | 96-36120CPT            | HPL    | 36 | 120 | 36  | 380     | 33.6      | P\$ 11290  |
|  | 95-36120CPT            | Veneer |    |     |     |         |           | W\$ 11546  |
|  | 96-3696CPT             | HPL    | 36 | 96  | 36  | 372     | 30.1      | P\$ 10958  |
|  | 95-3696CPT             | Veneer |    |     |     |         |           | W\$ 10962  |
|  | 96-3672CPT             | HPL    | 36 | 72  | 36  | 363     | 26.8      | P\$ 9840   |
|  | 95-3672CPT             | Veneer |    |     |     |         |           | W\$ 10105  |
|  | <b>Seated Height</b>   |        |    |     |     |         |           |            |
|  | 96-36120PT             | HPL    | 36 | 120 | 30  | 358     | 26.1      | P\$ 11003  |
|  | 95-36120PT             | Veneer |    |     |     |         |           | W\$ 11133  |
|  | 96-3696PT              | HPL    | 36 | 96  | 30  | 350     | 22.6      | P\$ 10687  |
| 95-3696PT  | Veneer                 |        |    |     |     |         | W\$ 10566 |            |
| 96-3672PT  | HPL                    | 36     | 72 | 30  | 342 | 19.3    | P\$ 9557  |            |
| 95-3672PT  | Veneer                 |        |    |     |     |         | W\$ 9691  |            |

Must Specify (in this order):

Model #  
Finish/Color

#### Description

- One Piece Parsons Table
- Parsons Tables are Formed with Mitered Construction to Provide a Clean Aesthetic
- Panel Legs Feature Aluminum Accents for Design Appeal
- Assembly Required

P = HPL W = Veneer

[See One10 Overview For Ordering Options](#)

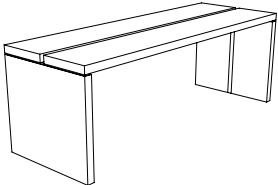

| Item  | Model No.    |                        | W           | D   | H   | Ship Wt | Cubic Ft | List Price |           |  |
|---|--------------|------------------------|-------------|-----|-----|---------|----------|------------|-----------|--|
| <b>PARSONS TABLES</b>   |              | <b>Standing Height</b> |             |     |     |         |          |            |           |  |
| <b>SPLIT TOP</b>  |              | <i>42"W</i>            |             |     |     |         |          |            |           |  |
|  | 96-42120TPST | HPL                    | 42          | 120 | 42  | 418     | 44.8     | P\$ 13862  |           |  |
|   | 95-42120TPST | Veneer                 |             |     |     |         |          | W\$ 14294  |           |  |
|   | 96-4296TPST  | HPL                    | 42          | 96  | 42  | 406     | 41.4     | P\$ 13547  |           |  |
|   | 95-4296TPST  | Veneer                 |             |     |     |         |          | W\$ 13633  |           |  |
|   | 96-4272TPST  | HPL                    | 42          | 72  | 42  | 395     | 38.0     | P\$ 13039  |           |  |
|   | 95-4272TPST  | Veneer                 |             |     |     |         |          | W\$ 12945  |           |  |
|   |              |                        | <i>36"W</i> |     |     |         |          |            |           |  |
|   |              | 96-36120TPST           | HPL         | 36  | 120 | 42      | 402      | 41.1       | P\$ 13529 |  |
|   |              | 95-36120TPST           | Veneer      |     |     |         |          |            | W\$ 13753 |  |
|   |              | 96-3696TPST            | HPL         | 36  | 96  | 42      | 393      | 37.7       | P\$ 13154 |  |
|   |              | 95-3696TPST            | Veneer      |     |     |         |          |            | W\$ 13301 |  |
|   |              | 96-3672TPST            | HPL         | 36  | 72  | 42      | 385      | 34.3       | P\$ 12684 |  |
|   | 95-3672TPST  | Veneer                 |             |     |     |         |          | W\$ 12371  |           |  |
|   |              | <b>Counter Height</b>  |             |     |     |         |          |            |           |  |
|   |              | <i>42"W</i>            |             |     |     |         |          |            |           |  |
|   | 96-42120CPST | HPL                    | 42          | 120 | 36  | 397     | 37.3     | P\$ 13136  |           |  |
|   | 95-42120CPST | Veneer                 |             |     |     |         |          | W\$ 14027  |           |  |
|   | 96-4296CPST  | HPL                    | 42          | 96  | 36  | 385     | 33.9     | P\$ 12799  |           |  |
|   | 95-4296CPST  | Veneer                 |             |     |     |         |          | W\$ 13284  |           |  |
|   | 96-4272CPST  | HPL                    | 42          | 72  | 36  | 374     | 30.5     | P\$ 12276  |           |  |
|   | 95-4272CPST  | Veneer                 |             |     |     |         |          | W\$ 12621  |           |  |
|   |              | <i>36"W</i>            |             |     |     |         |          |            |           |  |
|   | 96-36120CPST | HPL                    | 36          | 120 | 36  | 380     | 33.6     | P\$ 12838  |           |  |
|   | 95-36120CPST | Veneer                 |             |     |     |         |          | W\$ 13460  |           |  |
|   | 96-3696CPST  | HPL                    | 36          | 96  | 36  | 372     | 30.1     | P\$ 12504  |           |  |
|   | 95-3696CPST  | Veneer                 |             |     |     |         |          | W\$ 12999  |           |  |
|   | 96-3672CPST  | HPL                    | 36          | 72  | 36  | 363     | 26.8     | P\$ 12047  |           |  |
|   | 95-3672CPST  | Veneer                 |             |     |     |         |          | W\$ 12261  |           |  |
|   |              | <b>Seated Height</b>   |             |     |     |         |          |            |           |  |
|   |              | <i>42"W</i>            |             |     |     |         |          |            |           |  |
|   | 96-42120PST  | HPL                    | 42          | 120 | 30  | 377     | 36.0     | P\$ 12872  |           |  |
|   | 95-42120PST  | Veneer                 |             |     |     |         |          | W\$ 13666  |           |  |
|   | 96-4296PST   | HPL                    | 42          | 96  | 30  | 365     | 33.0     | P\$ 12518  |           |  |
|   | 95-4296PST   | Veneer                 |             |     |     |         |          | W\$ 12943  |           |  |
|   | 96-4272PST   | HPL                    | 42          | 72  | 30  | 354     | 29.5     | P\$ 12003  |           |  |
|   | 95-4272PST   | Veneer                 |             |     |     |         |          | W\$ 12370  |           |  |
|   |              | <i>36"W</i>            |             |     |     |         |          |            |           |  |
|   | 96-36120PST  | HPL                    | 36          | 120 | 30  | 360     | 32.5     | P\$ 12548  |           |  |
|   | 95-36120PST  | Veneer                 |             |     |     |         |          | W\$ 13031  |           |  |
|   | 96-3696PST   | HPL                    | 36          | 96  | 30  | 352     | 29.0     | P\$ 12231  |           |  |
|   | 95-3696PST   | Veneer                 |             |     |     |         |          | W\$ 12908  |           |  |
|   | 96-3672PST   | HPL                    | 36          | 72  | 30  | 343     | 25.8     | P\$ 11719  |           |  |
|   | 95-3672PST   | Veneer                 |             |     |     |         |          | W\$ 11973  |           |  |

Must Specify (in this order):

- Model #
- Finish/Color
- Power/Data Location

**Description**

- Split Top Parsons Table with Trough for Wire Management
- Parsons Tables are Formed with Mitered Construction to Provide a Clean Aesthetic
- Panel Legs Feature Aluminum Accents for Design Appeal
- Power and Data Options Available; Sold Separately, [See Multiple Power Unit Details](#); [See Locations Options](#)
- Assembly Required

P = HPL W = Veneer

[See One10 Overview For Ordering Options](#)

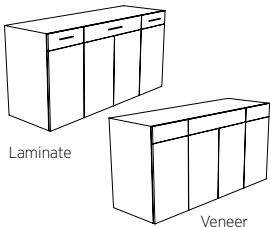
| Item  | Model No.                      |        | W  | D  | H  | Ship Wt | Cubic Ft | List Price |      |  |
|---|--------------------------------|--------|----|----|----|---------|----------|------------|------|--|
|  | <b>4 DOORS &amp; 3 DRAWERS</b> |        |    |    |    |         |          |            |      |  |
|   | 96-2460BF2                     | HPL    | 60 | 24 | 36 | 275     | 34.2     | P\$        | 5717 |  |
|   | 95-2460BF2                     | Veneer |    |    |    |         |          | W\$        | 7277 |  |
|   | <b>4 DOORS &amp; 2 DRAWERS</b> |        |    |    |    |         |          |            |      |  |
|   | 96-2460BF1                     | HPL    | 60 | 24 | 36 | 250     | 34.2     | P\$        | 4962 |  |
|   | 95-2460BF1                     | Veneer |    |    |    |         |          | W\$        | 6275 |  |
|   | <b>2 DOORS &amp; 1 DRAWER</b>  |        |    |    |    |         |          |            |      |  |
|   | 96-2430BF                      | HPL    | 30 | 24 | 36 | 150     | 17.6     | P\$        | 2613 |  |
|   | 95-2430BF                      | Veneer |    |    |    |         |          | W\$        | 3399 |  |

**Description**

- Touch Latch Doors
- Laminate Unit features Aluminum Beam Pull on Drawers While Veneer Unit Features Finger Pull
- Storage Behind Doors with Adjustable Shelves (Laminate or Veneer Shelves, Depending Upon Unit Specified)
- Adjustable Glides
- Finished Back

Must Specify (in this order):

Model #  
Finish/Color

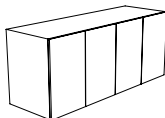
| Item  | Model No.      |        | W  | D  | H   | Ship Wt | Cubic Ft | List Price |      |  |
|---|----------------|--------|----|----|-----|---------|----------|------------|------|--|
|  | <b>4 DOORS</b> |        |    |    |     |         |          |            |      |  |
|   | 96-2472C       | HPL    | 72 | 24 | 30  | 290     | 28.0     | P\$        | 4461 |  |
|   | 95-2472C       | Veneer |    |    |     |         |          | W\$        | 6053 |  |
|   | <b>4 DOORS</b> |        |    |    |     |         |          |            |      |  |
|   | 96-2460C       | HPL    | 60 | 24 | 30  | 250     | 23.4     | P\$        | 4169 |  |
|   | 95-2460C       | Veneer |    |    |     |         |          | W\$        | 5336 |  |
|   | <b>3 DOORS</b> |        |    |    |     |         |          |            |      |  |
|   | 96-2448C       | HPL    | 48 | 24 | 30  | 210     | 19.5     | P\$        | 3062 |  |
|   | 95-2448C       | Veneer |    |    |     |         |          | W\$        | 4044 |  |
|   | <b>2 DOORS</b> |        |    |    |     |         |          |            |      |  |
| 96-2436C  | HPL            | 36     | 24 | 30 | 150 | 17.6    | P\$      | 2289       |      |  |
| 95-2436C  | Veneer         |        |    |    |     |         | W\$      | 3085       |      |  |

**Description**

- Touch Latch Doors; Veneer Units Also Feature Finger Pulls
- Storage Behind Doors with Adjustable Shelves
- Adjustable Glides
- Finished Back

Must Specify (in this order):

Model #  
Finish/Color

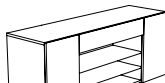
| Item  | Model No.      |        | W  | D  | H  | Ship Wt | Cubic Ft | List Price |      |  |
|---|----------------|--------|----|----|----|---------|----------|------------|------|--|
|  | <b>4 DOORS</b> |        |    |    |    |         |          |            |      |  |
|   | 96-1872OMC     | HPL    | 72 | 18 | 36 | 175     | 24.0     | P\$        | 4148 |  |
|   | 95-1872OMC     | Veneer |    |    |    |         |          | W\$        | 5327 |  |
|   | <b>2 DOORS</b> |        |    |    |    |         |          |            |      |  |
|   | 96-1860OMC     | HPL    | 60 | 18 | 36 | 155     | 19.5     | P\$        | 3830 |  |
|   | 95-1860OMC     | Veneer |    |    |    |         |          | W\$        | 4823 |  |

**Description**

- Storage Behind Two (2) Doors with Adjustable Laminate Shelves
- Open Storage with Two (2) Adjustable Metal Shelves in Middle Section Below Flip Down Door
- Flip Down Door (Does Not Feature Soft Close Hinges)
- Finished Back is Recessed and Open 2" Below Worksurface for Wire Management
- Touch Latch Closure; Veneer Units Also Feature Finger Pulls
- Adjustable Glides

Must Specify (in this order):

Model #  
Finish/Color

P = HPL W = Veneer

[See One10 Overview For Ordering Options](#)

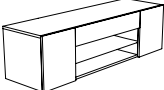
| Item  | Model No.   |        | W  | D  | H  | Ship Wt | Cubic Ft |     | List Price |
|---|-------------|--------|----|----|----|---------|----------|-----|------------|
|  | 96-1872LOMC | HPL    | 72 | 18 | 24 | 145     | 24.0     | P\$ | 3810       |
|   | 95-1872LOMC | Veneer |    |    |    |         |          | W\$ | 4967       |
|   | 96-1860LOMC | HPL    | 60 | 18 | 24 | 125     | 19.5     | P\$ | 3564       |
|   | 95-1860LOMC | Veneer |    |    |    |         |          | W\$ | 4548       |

### Description

- Storage Behind Two (2) Doors with Adjustable Veneer Shelves
- Open Storage with Adjustable Metal Shelf in Middle Section Below Flip Down Door
- Flip Down Door (Does Not Feature Soft Close Hinges)
- Finished Back is Recessed and Open 2" Below Worksurface for Wire Management
- Touch Latch Doors; Veneer Units Also Feature Finger Pulls
- Adjustable Glides

### Must Specify (in this order):

Model #  
Finish/Color

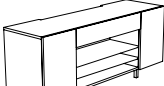
| Item  | Model No.  |        | W  | D  | H  | Ship Wt | Cubic Ft |     | List Price |
|---|------------|--------|----|----|----|---------|----------|-----|------------|
|  | 96-1872FMC | HPL    | 72 | 18 | 36 | 175     | 24.0     | P\$ | 3992       |
|   | 95-1872FMC | Veneer |    |    |    |         |          | W\$ | 5240       |
|   | 96-1860FMC | HPL    | 60 | 18 | 36 | 155     | 19.5     | P\$ | 3770       |
|   | 95-1860FMC | Veneer |    |    |    |         |          | W\$ | 4833       |

### Description

- Storage Behind Two (2) Doors with Adjustable Shelves (Laminate or Veneer Shelves, Depending Upon Unit Specified)
- Open Storage with Two (2) Adjustable Metal Shelves in Middle Section Below Flip Down Door
- Flip Down Door (Does Not Feature Soft Close Hinges)
- Finished Back is Recessed and Open 2" Below Worksurface for Wire Management
- Top is Routed to Accommodate Wire Management or Flat Panel Monitor Stand ([See Flat Panel Monitor Stand](#))
- Touch Latch Doors; Veneer Units Also Feature Finger Pulls
- Doors are Hinged from the Inside of the Cabinet and Swing in to Accommodate the Meeting Table
- Aluminum Post Legs with Adjustable Glides

### Must Specify (in this order):

Model #  
Finish/Color

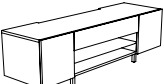
| Item  | Model No.   |        | W  | D  | H  | Ship Wt | Cubic Ft |     | List Price |
|---|-------------|--------|----|----|----|---------|----------|-----|------------|
|  | 96-1872LFMC | HPL    | 72 | 18 | 24 | 145     | 24.0     | P\$ | 3548       |
|   | 95-1872LFMC | Veneer |    |    |    |         |          | W\$ | 4364       |
|   | 96-1860LFMC | HPL    | 60 | 18 | 24 | 125     | 19.5     | P\$ | 3362       |
|   | 95-1860LFMC | Veneer |    |    |    |         |          | W\$ | 4106       |

### Description

- Storage Behind Two (2) Doors with Adjustable Shelves (Laminate or Veneer Shelves, Depending Upon Unit Specified)
- Open Storage with Adjustable Metal Shelf in Middle Section Below Flip Down Door
- Flip Down Door (Does Not Feature Soft Close Hinges)
- Finished Back is Recessed and Open 2" Below Worksurface for Wire Management
- Top is Routed to Accommodate Wire Management or Flat Panel Monitor Stand ([See Flat Panel Monitor Stand](#))
- Touch Latch Doors; Veneer Units Also Feature Finger Pulls
- Doors are Hinged from the Inside of the Cabinet and Swing in to Accommodate the Meeting Table
- Aluminum Post Legs with Adjustable Glides

### Must Specify (in this order):

Model #  
Finish/Color

P = HPL W = Veneer

[See One10 Overview For Ordering Options](#)

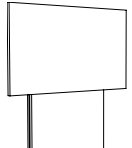
| Item   | Model No.  |        | W   | D  | H   | Ship Wt | Cubic Ft | List Price |      |
|--|--|--------|-----|----|-----|---------|----------|------------|------|
| <b>FLAT PANEL MONITOR STAND</b><br><br>Shown with Monitor<br>(Not Included) | <b>COORDINATES WITH ≥60" MEETING TABLES 42" TALL AND FOOTED MEDIA CREDENZAS 36"H</b>     |        |     |    |     |         |          |            |      |
|  | 96-3067FP  | HPL    | 30½ | 14 | 67% | 140     | 16.7     | P\$        | 2099 |
|  | 95-3067FP  | Veneer |     |    |     |         |          | W\$        | 2634 |
|  | <b>COORDINATES WITH ≥60" MEETING TABLES 42" TALL AND LOW FOOTED MEDIA CREDENZAS 24"H</b> |        |     |    |     |         |          |            |      |
|  | 96-3055FP  | HPL    | 30½ | 14 | 55% | 123     | 13.8     | P\$        | 1921 |
|  | 95-3055FP  | Veneer |     |    |     |         |          | W\$        | 2366 |

**Description**

- Not Freestanding; Must be Used with a Coordinating Product
- Finished Back is Removable for Wire Management
- Grain Direction is Vertical
- Aluminum Metal Base
- Accommodates 200, 300, and 400mm VESA Patterns
- Check the Monitor Manufacturer's Specifications for Compliance
- Mounting Hardware Not Included
- Not Responsible for Monitors Improperly Installed or Any Attempt To Use As A Freestanding Unit

Must Specify (in this order):

- Model #
- Finish/Color

|   |           |        |    |    |    |     |      |     |      |
|---|-----------|--------|----|----|----|-----|------|-----|------|
| <b>LECTERN STAND</b><br> | 96-2650LS | HPL    | 24 | 23 | 49 | 130 | 21.9 | P\$ | 1801 |
|   | 95-2650LS | Veneer |    |    |    |     |      | W\$ | 3019 |

**Description**

- Top Fixed Shelf Angled for User Comfort
- Two (2) Fixed Shelves and One (1) Adjustable Shelf
- Two (2) Locking and Two (2) Non-Locking Casters
- Wire Management Grommet on Second and Bottom Shelf, Middle Shelf Features Wire Management Grommet Cut Out

Must Specify (in this order):

- Model #
- Finish/Color

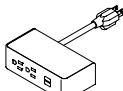
|   |              |        |    |   |   |   |     |    |     |
|---|--------------|--------|----|---|---|---|-----|----|-----|
| <b>DUO CLAMP NEMA PLUG</b><br> | 01-DUOCLAMPW | White  | 5½ | 3 | 7 | 1 | 0.2 | \$ | 537 |
|   | 01-DUOCLAMPB | Black  |    |   |   |   |     | \$ | 537 |
|   | 01-DUOCLAMPS | Silver |    |   |   |   |     | \$ | 537 |

**Description**

- Clamps to Table Top and Includes: Two (2) Power, Two (2) USB, 10' Cord, and All Mounting Hardware
- Silver Metal Trim on All Color Options
- Independent USB Circuit Controllers Deliver up to 2.1 Amps to Each Post
- FCC Part 15A, UL Recognized for Horizontal and Vertical Applications

|  |               |        |   |   |   |   |     |    |     |
|--|---------------|--------|---|---|---|---|-----|----|-----|
| <b>TRIO CLAMP NEMA PLUG</b><br> | 01-TRIOCLAMPW | White  | 8 | 3 | 7 | 1 | 0.2 | \$ | 629 |
|  | 01-TRIOCLAMPB | Black  |   |   |   |   |     | \$ | 629 |
|  | 01-TRIOCLAMPS | Silver |   |   |   |   |     | \$ | 629 |

**Description**

- Clamps to Table Top and Includes: Three (3) Power Outlets, Two (2) USB Ports, One (1) Open Data Port, 10' Cord, and All Mounting Hardware
- HDMI, VGA, and RJ45 Accessories for Open Data Port; Sold Separately, [See Accessories](#)
- Silver Metal Trim on All Color Options
- Independent USB Circuit Controllers Deliver up to 2.1 Amps to Each Post
- FCC Part 15A, UL Recognized for Horizontal and Vertical Applications

P = HPL W = Veneer

[See One10 Overview For Ordering Options](#)

| Item  | Model No.    |        | W  | D  | H  | Ship Wt | Cubic Ft | List Price |
|---|--------------|--------|----|----|----|---------|----------|------------|
|  | 01-DUOBEZELW | White  | 6½ | 2¼ | 3⅞ | 1       | 0.2      | \$ 633     |
|   | 01-DUOBEZELB | Black  |    |    |    |         |          | \$ 633     |
|   | 01-DUOBEZELS | Silver |    |    |    |         |          | \$ 633     |

**Description**

- Sits on Table Top and Includes: Two (2) Power, Two (2) USB, 10' Cord, and All Mounting Hardware
- Independent USB Circuit Controllers Deliver up to 2.1 Amps to Each Post
- FCC Part 15A, UL Recognized for Horizontal and Vertical Applications
- Works with One10 Small Meeting Tables, Standard Tables, and Single Column Meeting Tables

|   |               |        |   |    |   |   |     |        |
|---|---------------|--------|---|----|---|---|-----|--------|
|  | 01-TRIOBEZELW | White  | 9 | 2¼ | 3 | 1 | 0.2 | \$ 680 |
|   | 01-TRIOBEZELB | Black  |   |    |   |   |     | \$ 680 |
|   | 01-TRIOBEZELS | Silver |   |    |   |   |     | \$ 680 |

**Description**

- Sits on Table Top and Includes: Three (3) Power Outlets, Two (2) USB Ports, One (1) Open Data Port, 10' Cord, and All Mounting Hardware
- HDMI, VGA, and RJ45 Accessories for Open Data Port; Sold Separately, [See Accessories](#)
- Independent USB Circuit Controllers Deliver up to 2.1 Amps to Each Post
- FCC Part 15A, UL Recognized for Horizontal and Vertical Applications
- Works with One10 Small Meeting Tables, Standard Tables, and Single Column Meeting Tables

|   |         |        |    |   |    |   |     |        |
|---|---------|--------|----|---|----|---|-----|--------|
|  | 01-DUOW | White  | 5½ | 2 | 3⅞ | 1 | 0.2 | \$ 667 |
|   | 01-DUOB | Black  |    |   |    |   |     | \$ 667 |
|   | 01-DUOS | Silver |    |   |    |   |     | \$ 667 |

**Description**

- Sits Between Worksurfaces or Below the Worksurface and Includes: Two (2) Power, Two (2) USB, 10' Cord, and All Mounting Hardware
- Independent USB Circuit Controllers Deliver up to 2.1 Amps to Each Post
- FCC Part 15A, UL Recognized for Horizontal and Vertical Applications
- Works with One10 Small Meeting Tables, Standard Tables with Center Inlay, Standard Tables with Center Channel, and Parsons Tables with Split Top

|   |           |        |   |   |   |   |     |        |
|---|-----------|--------|---|---|---|---|-----|--------|
|  | 01-TRIOBW | White  | 8 | 2 | 3 | 1 | 0.2 | \$ 687 |
|   | 01-TRIOB  | Black  |   |   |   |   |     | \$ 687 |
|   | 01-TRIOS  | Silver |   |   |   |   |     | \$ 687 |

**Description**

- Sits Between Worksurfaces or Below the Worksurface and Includes: Three (3) Power Outlets, Two (2) USB Ports, One (1) Open Data Port, 10' Cord, and All Mounting Hardware
- HDMI, VGA, and RJ45 Accessories for Open Data Port; Sold Separately, [See Accessories](#)
- Independent USB Circuit Controllers Deliver up to 2.1 Amps to Each Post
- FCC Part 15A, UL Recognized for Horizontal and Vertical Applications
- Works with One10 Small Meeting Tables, Standard Tables with Center Inlay, Standard Tables with Center Channel, and Parsons Tables with Split Top

| Item  | Model No.     |        | W  | D  | H | Ship Wt | Cubic Ft | List Price |
|---|---------------|--------|----|----|---|---------|----------|------------|
|  | 01-PDUOBEZELW | White  | 6½ | 2½ | 3 | 1       | 0.2      | \$ 626     |
|   | 01-PDUOBEZELB | Black  |    |    |   |         |          | \$ 626     |
|   | 01-PDUOBEZELS | Silver |    |    |   |         |          | \$ 626     |

**Description**

- Sits on Table Top and Includes: Two (2) Power, Two (2) USB, 12” Cord, and All Mounting Hardware
- Requires Daisy Chain Power Box; Sold Separately, [See Power Box Details](#)
- Non-Sequential System Allows up to Eight (8) Modules to be Connected with Jumper Cord, [See Jumper Cord Details](#)
- Independent USB Circuit Controllers Deliver up to 2.1 Amps to Each Post
- FCC Part 15A, RU Listed and UL Recognized for Horizontal and Vertical Applications
- Works with One10 Small Meeting Tables, Standard Tables, and Single Column Meeting Tables

|   |                |        |   |    |   |   |     |        |
|---|----------------|--------|---|----|---|---|-----|--------|
|  | 01-PTRIOBEZELW | White  | 9 | 2½ | 3 | 1 | 0.2 | \$ 671 |
|   | 01-PTRIOBEZELB | Black  |   |    |   |   |     | \$ 671 |
|   | 01-PTRIOBEZELS | Silver |   |    |   |   |     | \$ 671 |

**Description**

- Sits on Table Top and Includes: Three (3) Power Outlets, Two (2) USB Ports, One (1) Open Data Port, 12” Cord, and All Mounting Hardware
- HDMI, VGA, or RJ45 Accessory for Open Data Port; Sold Separately, [See Accessories](#)
- Requires Daisy Chain Power Box, Specified Separately, See Next Page
- Non-Sequential System Allows up to Eight (8) Modules to be Connected with Jumper Cord, [See Jumper Cord Details](#)
- Independent USB Circuit Controllers Deliver up to 2.1 Amps to Each Post
- FCC Part 15A, RU Listed and UL Recognized for Horizontal and Vertical Applications
- Works with One10 Small Meeting Tables, Standard Tables, and Single Column Meeting Tables

|   |          |        |    |   |   |   |     |        |
|---|----------|--------|----|---|---|---|-----|--------|
|  | 01-PDUOW | White  | 5½ | 2 | 3 | 1 | 0.2 | \$ 661 |
|   | 01-PDUOB | Black  |    |   |   |   |     | \$ 661 |
|   | 01-PDUOS | Silver |    |   |   |   |     | \$ 661 |

**Description**

- Sits Between Worksurfaces or Below the Worksurface and Includes: Two (2) Power, Two (2) USB, 12” Cord, and All Mounting Hardware
- Requires Daisy Chain Power Box; Sold Separately, [See Power Box Details](#)
- Non-Sequential System Allows up to Eight (8) Modules to be Connected with Jumper Cord, [See Jumper Cord Details](#)
- Independent USB Circuit Controllers Deliver up to 2.1 Amps to Each Post
- FCC Part 15A, RU Listed and UL Recognized for Horizontal and Vertical Applications
- Works with One10 Small Meeting Tables, Standard Tables with Center Inlay, Standard Tables with Center Channel, and Parsons Tables with Split Top

[See One10 Overview For Ordering Options](#)

| Item  | Model No. |        | W | D | H | Ship Wt | Cubic Ft | List Price |
|---|-----------|--------|---|---|---|---------|----------|------------|
|  | 01-PTRIOW | White  | 8 | 2 | 3 | 1       | 0.2      | \$ 680     |
|   | 01-PTRIOB | Black  |   |   |   |         |          | \$ 680     |
|   | 01-PTRIOS | Silver |   |   |   |         |          | \$ 680     |

**Description**

- Sits on Table Top and Includes: Three (3) Power Outlets, Two (2) USB Ports, One (1) Open Data Port, 12" Cord, and All Mounting Hardware
- HDMI, VGA, or RJ45 Accessory for Open Data Port; Sold Separately, See Accessories Below
- Requires Daisy Chain Power Box; Sold Separately, See Details Below
- Non-Sequential System Allows up to Eight (8) Modules to be Connected with Jumper Cord, [See Jumper Cord Details](#)
- Independent USB Circuit Controllers Deliver up to 2.1 Amps to Each Post
- FCC Part 15A, RU Listed and UL Recognized for Horizontal and Vertical Applications
- Works with One10 Small Meeting Tables, Standard Tables with Center Inlay, Standard Tables with Center Channel, and Parsons Tables with Split Top

|   |             |  |   |   |   |   |     |        |
|---|-------------|--|---|---|---|---|-----|--------|
| HDMI DATA PORT ACCESSORY FOR TRIO UNITS | 01-LCOMHDMI |  | - | - | - | 1 | 0.2 | \$ 155 |
|---|-------------|--|---|---|---|---|-----|--------|

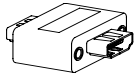

Open Market

|  |            |  |   |   |   |   |     |        |
|--|------------|--|---|---|---|---|-----|--------|
| VGA DATA PORT ACCESSORY FOR TRIO UNITS | 01-LCOMVGA |  | - | - | - | 1 | 0.2 | \$ 114 |
|--|------------|--|---|---|---|---|-----|--------|

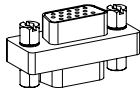

|   |             |  |   |   |   |   |     |       |
|---|-------------|--|---|---|---|---|-----|-------|
| RJ45 DATA PORT ACCESSORY FOR TRIO UNITS | 01-LCOMRJ45 |  | - | - | - | 1 | 0.2 | \$ 74 |
|---|-------------|--|---|---|---|---|-----|-------|

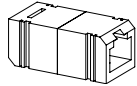

|                       |            |                                       |   |   |   |   |     |        |
|-----------------------|------------|---------------------------------------|---|---|---|---|-----|--------|
| DAISY CHAIN POWER BOX | 01-PPOWER  |                                       | - | - | - | 1 | 0.2 | \$ 727 |
|                       |            | <i>76" Perimeter, 36" Power Cord</i>  |   |   |   |   |     |        |
|                       | 01-PPOWER2 |                                       | - | - | - | 1 | 0.2 | \$ 747 |
|                       |            | <i>24" Perimeter, 144" Power Cord</i> |   |   |   |   |     |        |



**Description**

- Powers up to Eight (8) Duo and Trio Daisy Chain Units
- One Nema Plug and One Daisy Chain Plug
- 12-Amp System Rating
- 15-Amp Over-Current Protection

[See One10 Overview For Ordering Options](#)

| Item  | Model No. |          | W | D | H | Ship Wt | Cubic Ft | List Price |
|---|-----------|----------|---|---|---|---------|----------|------------|
|  DAISY CHAIN JUMPER CORD | 01-6JUMP  | 72" Long | - | - | - | 1       | 0.2      | \$ 281     |
|   | 01-5JUMP  | 60" Long | - | - | - | 1       | 0.2      | \$ 266     |
|   | 01-4JUMP  | 48" Long | - | - | - | 1       | 0.2      | \$ 225     |
|   | 01-2JUMP  | 24" Long | - | - | - | 1       | 0.2      | \$ 207     |

**Description**

- Connects Duo and Trio Daisy Chain Units
- Non-Sequential System Allows up to Eight (8) Modules to be Connected

|                    |          |  |     |    |     |    |     |         |
|--------------------|----------|--|-----|----|-----|----|-----|---------|
| VESTA POWER CENTER | 01-PDCTR |  | 10¾ | 12 | 28¼ | 14 | 2.5 | \$ 1666 |
|--------------------|----------|--|-----|----|-----|----|-----|---------|

**Description**

- Top Includes One (1) Power Outlet, Two (2) USB Ports and One (1) USBC Port; Base Includes Three (3) Outlet
- Available in White
- 120" Power Cord
- Built with Weight Distribution for Optimal Stability
- Base is 5" Tall

|             |         |  |   |   |   |   |   |        |
|-------------|---------|--|---|---|---|---|---|--------|
| POWER STRIP | 01-PRSP |  | 9 | 2 | 2 | 1 | - | \$ 192 |
|-------------|---------|--|---|---|---|---|---|--------|

**Description**

- Includes Four (4) Outlets and Two (2) Phone Jacks
- Black Plastic with Rocker On/Off Switch
- 13 Amp Circuit Breaker
- 10' Power Cord and Two (2) 14' Phone Hook Up Cords
- UL and CSA Recognized
- Suitable for Surface or Recessed Mounting
- Ships via UPS Only

|               |          |  |    |    |   |   |   |        |
|---------------|----------|--|----|----|---|---|---|--------|
| WIRE MANAGERS | 01-WMGR4 |  | 16 | 1½ | ¾ | 1 | - | \$ 109 |
|---------------|----------|--|----|----|---|---|---|--------|

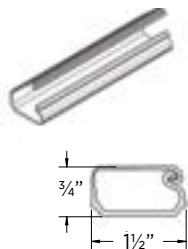
**Description**

- Four (4) Wire Manager Strips
- Black Plastic
- Snap Lock Channel
- Attaches with Adhesive Strips
- Can be Placed on All Units to Route Wires

|            |           |  |    |    |   |   |   |       |
|------------|-----------|--|----|----|---|---|---|-------|
| CABLE GRIP | 01-WMGRCB |  | 5¾ | 2¾ | - | - | - | \$ 16 |
|------------|-----------|--|----|----|---|---|---|-------|

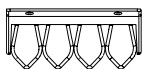
**Description**

- Under Surface Wire Management
- Black

[See One10 Overview For Ordering Options](#)



Crafted in select solids and American veneers, Phoenix's clean, transitional styling is at ease in both contemporary and traditional settings. It is a perfect choice for value-minded companies who want a sophisticated, yet uncomplicated, furniture solution.

### CONSTRUCTION

*Phoenix features a Veneer chassis with your choice of a Veneer or HPL top.*

### VENEER

- Exposed surfaces feature select grade sliced American Black Walnut or Cherry veneers carefully selected and matched to assure proper balance and consistency

### TOPS

- Veneer tops are 5-ply balanced construction and 1 $\frac{1}{32}$ " thick with solid hardwood rims
- High Pressure Laminate (HPL) tops are 3-ply balanced construction and 1 $\frac{1}{32}$ " thick with solid hardwood rims
- Grain direction runs left to right unless noted

### CHASSIS

- Chassis is securely fastened using high quality European fastening systems and heavy-duty, 16-gauge joining brackets to assure maximum strength
- Units feature finished backs unless otherwise noted
- All units equipped with heavy-duty, adjustable glides to ensure proper leveling and compensate for uneven floors

### DRAWERS

- Drawer fronts standard with matched veneer faces
- Drawer sides, back and front are woodgrain vinyl-wrapped, and are  $\frac{1}{2}$ " thick
- 5-sided drawer construction for easy removal of drawer fronts
- Lateral file drawers feature  $\frac{1}{4}$ " thick bottoms and tested for 200lb capacity
- All drawers feature full extension, progressive action slides with precision steel ball bearings
- All suspensions have a limited lifetime warranty

### FILING

- File drawers are standard with filing systems designed to accommodate a variety of filing requirements
- Letter width file drawers provide letter filing front to back and legal filing side to side

### STORAGE

- All hinged doors include soft close hinges, unless noted
- One piece hinge and base plate combination
- Soft close hinges reduce stress placed on the cabinet when the door is closed and offers a quiet closure

### LOCKING

- Storage credenzas feature standard locking; optional locking on wardrobe/storage cabinets
- Lock core will coordinate with pull selection unless otherwise noted
- Removable lock cylinders allow for units to be re-keyed at a later date if required
- Units are shipped randomly keyed as standard. Keyed alike units available upon request at no additional charge.

### INTERIOR DRAWER DIMENSIONS & FILING CAPABILITIES

#### Models

21-2072SC      21-2066SC

#### Drawers

File

W

12 $\frac{1}{8}$ "

L

16 $\frac{3}{16}$ "

D

9 $\frac{1}{16}$ "

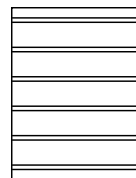

Letter Front to Back

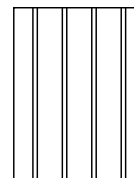

Legal Side to Side

### HOW TO ORDER EXAMPLES

|           | Model No.  | QTY | Description   | Example |
|-----------|------------|-----|---------------|---------|
| TABLE TOP | 21-4848CT  | 1   | Top Material  | P       |
|           |            |     | Finish/Color  | CO      |
| BASE      | 01-3230DBB | 1   | Disc Base     |         |
| CREDENZA  | 21-2072SC  | 1   | Top Material  | W       |
|           |            |     | Finish/Color  | CO      |
|           |            |     | Pull          | NBT     |
|           |            |     | Flush Feature | -       |

### VENEER (W) OPTIONS

Veneer features UVAdvantage, an ultra-violet finish, on all exposed surfaces by utilizing roll-coat UV technology.

*Note: Base molding, decorative molding and cylinder base feature multi-step, hand-finished catalyzed finish.*

|     |                    |     |                     |
|-----|--------------------|-----|---------------------|
| AW  | Artisan Walnut     | HW  | Harvest Walnut      |
| CO  | Columbian Walnut   | LW  | Legacy Walnut       |
| DC  | Dark Cherry        | MW  | Mahogany Walnut     |
| DFW | Dark Forest Walnut | SCH | Select Cherry       |
| EW  | Espresso           | SKC | Shaker Cherry       |
| GC  | Golden Cherry      | WC  | Williamsburg Cherry |

### HPL (P) TOP OPTIONS

#### WOODGRAIN

|    |                  |     |                     |
|----|------------------|-----|---------------------|
| CO | Columbian Walnut | SCH | Select Cherry       |
| EF | Espresso         | SKC | Shaker Cherry       |
| GC | Golden Cherry    | WC  | Williamsburg Cherry |
| MW | Mahogany Walnut  |     |                     |

**EDGE PROFILE**

O Phoenix



Phoenix (O)

**FLUSH FEATURE OPTION**

Select units feature multiple flush options allowing units to be placed next to each other. See specific units for details. Must specify when placing ordering.

- FL Flush Left
- FR Flush Right
- FLR Flush Left and Right



(FL) Flush Left Shown

**PULL OPTIONS**

*Note: Lock Core will match Pull Color*

- |                      |                      |
|----------------------|----------------------|
| AAC Arc, Aluminum    | AEL Elite, Aluminum  |
| BAC Arc, Black       | BEL Elite, Black     |
| ABM Beam, Aluminum   | AFL Flair, Aluminum  |
| BBM Beam, Black      | CFL Flair, Chrome    |
| BBT Bow Tie, Black   | AFC Focus, Aluminum  |
| NBT Bow Tie, Nickel  | BFC Focus, Black     |
| ABU Buckle, Aluminum | AQD Quadra, Aluminum |
| BBU Buckle, Black    | BQD Quadra, Black    |

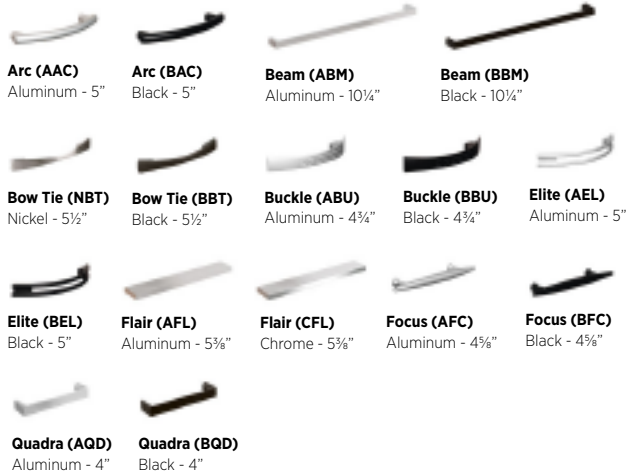

**LOCKING DOORS**

Locking doors are available on Wardrobes. You must specify WITH LOCKING when ordering and add upcharge.

|        |                   |    |    |
|--------|-------------------|----|----|
| LKT_HU | 36"W - 30"W Units | \$ | 85 |
| LKT_HU | 18"W Units        | \$ | 65 |

**LOCK CORE OPTIONS**

Lock core will coordinate with pull color unless otherwise noted.

- BLK Black
- SLV Silver



Black (BLK) Silver (SLV)

**CERTIFICATIONS & COMPLIANCE**

- Intertek Sustainability Certified
- BIFMA level® Certified
- BIFMA Compliant Certified
- TSCA Title VI (formerly CARB) Compliance
- US Green Building's LEED Contribution

**Tops and Bases**



Circular Tops  
[\(See Details\)](#)



Disc Bases  
[\(See Details\)](#)



Small and Large X  
Bases [\(See Details\)](#)



HA Pneumatic X  
Bases [\(See Details\)](#)



Metal Bases  
[\(See Details\)](#)

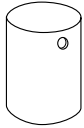

Cylinder  
[\(See Details\)](#)

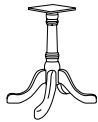

Queen Anne  
[\(See Details\)](#)

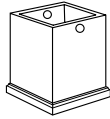

Square  
[\(See Details\)](#)

**Storage Components**

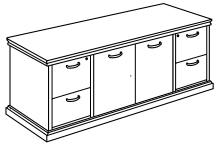

Storage Credenzas  
[\(See Details\)](#)

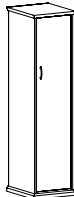

Wardrobe/Storage  
[\(See Details\)](#)

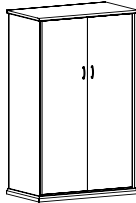

Double Wardrobe/ Storage  
[\(See Details\)](#)

For additional solutions for desking, storage, and accessories, see the [Phoenix Casegoods](#) and [Accessories](#) Price Lists.

| Item  | Model No.   | Width | Depth | Height          | Ship Wt | Cubic Ft | List Price           |
|---|---|-------|-------|-----------------|---------|----------|----------------------|
|  | 21-4848CT<br><i>Accommodates Five (5) Chairs</i>  | 48    | 48    | 1½ <sup>2</sup> | 63      | 5.7      | P\$ 1488<br>W\$ 1921 |
|   | 21-4242CT<br><i>Accommodates Four (4) Chairs</i>  | 42    | 42    | 1½ <sup>2</sup> | 40      | 4.4      | P\$ 1380<br>W\$ 1774 |
|   | 21-3636CT<br><i>Accommodates Three (3) Chairs</i> | 36    | 36    | 1½ <sup>2</sup> | 35      | 3.4      | P\$ 1279<br>W\$ 1627 |

Must Specify (in this order):

Model #  
Top Material  
Finish/Color

#### Description

- Single Base Required; Ordered Separately (See Below and [Additional Base Options](#))
- Power Options not Available

#### DISC BASE



| For 48" Circular Tops         |          |    |    |     |    |     |         |  |
|-------------------------------|----------|----|----|-----|----|-----|---------|--|
| 01-3230DBB                    | Black    | 30 | 30 | 27¾ | 42 | 4.1 | \$ 1728 |  |
| 01-3230DBA                    | Aluminum | 30 | 30 | 27¾ | 42 | 4.1 | \$ 1728 |  |
| For 36" and 42" Circular Tops |          |    |    |     |    |     |         |  |
| 01-2430DBB                    | Black    | 24 | 24 | 27¾ | 32 | 3.2 | \$ 1440 |  |
| 01-2430DBA                    | Aluminum | 24 | 24 | 27¾ | 32 | 3.2 | \$ 1440 |  |

#### Description

- 4" Diameter Column

#### METAL X-BASE

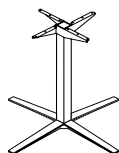

| For 42" and 48" Circular Tops |          |     |     |    |    |      |         |  |
|-------------------------------|----------|-----|-----|----|----|------|---------|--|
| 08-2642LXB                    | Aluminum | 35½ | 35½ | 40 | 33 | 20.0 | \$ 1240 |  |
| <i>For 42" High Tables</i>    |          |     |     |    |    |      |         |  |
| 08-2636LXB                    | Aluminum | 35½ | 35½ | 34 | 30 | 17.2 | \$ 1196 |  |
| <i>For 36" High Tables</i>    |          |     |     |    |    |      |         |  |
| 08-2630LXB                    | Aluminum | 35½ | 35½ | 28 | 27 | 14.5 | \$ 1144 |  |
| <i>For 30" High Tables</i>    |          |     |     |    |    |      |         |  |
| For 36" Circular Tops         |          |     |     |    |    |      |         |  |
| 08-2042SXB                    | Aluminum | 29½ | 29½ | 40 | 27 | 15.9 | \$ 1158 |  |
| <i>For 42" High Tables</i>    |          |     |     |    |    |      |         |  |
| 08-2036SXB                    | Aluminum | 29½ | 29½ | 34 | 24 | 13.7 | \$ 1112 |  |
| <i>For 36" High Tables</i>    |          |     |     |    |    |      |         |  |
| 08-2030SXB                    | Aluminum | 29½ | 29½ | 28 | 21 | 11.6 | \$ 1068 |  |
| <i>For 30" High Tables</i>    |          |     |     |    |    |      |         |  |

#### Description

- Not Available to Be Sold Separately

#### HEIGHT ADJUSTABLE PNEUMATIC X-BASE

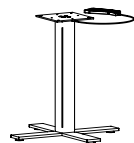

| Maximum Round 42", Maximum Square 36" |          |    |    |        |   |     |         |  |
|---------------------------------------|----------|----|----|--------|---|-----|---------|--|
| 01-3232HAXBB                          | Black    | 32 | 32 | 26-45¾ | 1 | 0.2 | \$ 1615 |  |
| 01-3232HAXBA                          | Aluminum | 32 | 32 | 26-45¾ | 1 | 0.2 | \$ 1615 |  |
| Maximum Round 36", Maximum Square 30" |          |    |    |        |   |     |         |  |
| 01-2626HAXBB                          | Black    | 22 | 22 | 26-45¾ | 1 | 0.2 | \$ 1583 |  |
| 01-2626HAXBA                          | Aluminum | 22 | 22 | 26-45¾ | 1 | 0.2 | \$ 1583 |  |

#### Description

- Pre-Drilled Boring Pattern May Not Match Underside of Table Top
- Steel Mounting Plate: 8"x 8"x ¼"
- Eight (8) \*MM Bolts Included for Assembly
- Ships KD

P = HPL W = Veneer

For ordering options, see overview at the beginning of this section.

| Item       | Model No.  |          | Width | Depth | Height | Ship Wt | Cubic Ft | List Price |
|------------|------------|----------|-------|-------|--------|---------|----------|------------|
| METAL BASE | 01-0400MBB | Black    | 32    | 32    | 27¾    | 32      | 3.2      | \$ 936     |
|            | 01-0400MBA | Aluminum | 32    | 32    | 27¾    | 32      | 3.2      | \$ 936     |



Open Market Only

**Description**  
 • Shipped KD; Some Assembly Required

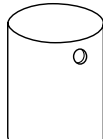
| CYLINDER BASE   | For Tables 42"D to 48"D |  |    |    |     |     |      |          |
|---|-------------------------|--|----|----|-----|-----|------|----------|
|  | 01-2020CB               |  | 20 | 20 | 28½ | 136 | 10.9 | W\$ 1456 |
|   | For Tables 36"D         |  |    |    |     |     |      |          |
|   | 01-1616CB               |  | 16 | 16 | 28½ | 101 | 7.2  | W\$ 1331 |

Must Specify (in this order):  
 Model #  
 Finish  
 Grommet Options

**Description**  
 • Veneer Base Features Multi-Step, Hand-Finished Catalyzed Finish  
 • Weighted for Stability  
 • Two (2) Wire Management Black Grommets Standard at Top Edge; 8" Opening Standard at Bottom

**Additional Grommet Options: Specify & Add**

|       |                                  |    |     |
|-------|----------------------------------|----|-----|
| GCB1S | Only One (1) Grommet At Top Edge | \$ | N/C |
| NOGC  | No Grommets At Top Edge          | \$ | N/C |

|                 |           |  |    |    |     |     |      |          |
|-----------------|-----------|--|----|----|-----|-----|------|----------|
| QUEEN ANNE BASE | 01-0606QB |  | 20 | 20 | 28¼ | 136 | 11.1 | W\$ 1318 |
|-----------------|-----------|--|----|----|-----|-----|------|----------|

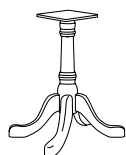

Must Specify (in this order):  
 Model #  
 Finish

**Description**  
 • Classic Design Detail on Column  
 • Base Features Multi-Step, Hand-Finished Catalyzed Finish  
 • Four (4) Legs with Adjustable Glides

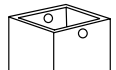
| SQUARE BASE   |           |                                     | Width | Depth | Height | Ship Wt | Cubic Ft | List Price |
|---|-----------|-------------------------------------|-------|-------|--------|---------|----------|------------|
|  | 21-2020SB |                                     | 20    | 20    | 28¼    | 57      | 8.4      | W\$ 1110   |
|   |           | <i>For Use with 48" or 42" Tops</i> |       |       |        |         |          |            |
|   | 21-1616SB |                                     | 16    | 16    | 28¼    | 41      | 6.0      | W\$ 1032   |
|   |           | <i>For Use with 36" Top</i>         |       |       |        |         |          |            |

Must Specify (in this order):  
 Model #  
 Finish  
 Grommet Options

**Description**  
 • Veneer Base  
 • Two (2) Wire Management Black Grommets Standard at Top and 8" Wire Management Opening in Bottom

**Options: Specify & Add**

|      |                        |    |     |
|------|------------------------|----|-----|
| NOGC | No Grommet at Top Edge | \$ | N/C |
|------|------------------------|----|-----|



P = HPL W = Veneer

For ordering options, see overview at the beginning of this section.

| Item             | Model No. | Width | Depth                           | Height | Ship Wt | Cubic Ft | List Price           |
|------------------|-----------|-------|---------------------------------|--------|---------|----------|----------------------|
| STORAGE CREDENZA | 21-2072SC | 72    | 20 <sup>7</sup> / <sub>16</sub> | 30     | 349     | 29.0     | P\$ 4090<br>W\$ 4459 |
|                  | 21-2066SC | 66    | 20 <sup>7</sup> / <sub>16</sub> | 30     | 320     | 26.6     | P\$ 3946<br>W\$ 4305 |

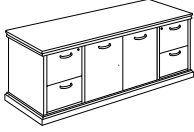

Must Specify (in this order):

Model #  
Top Material  
Finish/Color  
Pull  
Flush Feature

**Description**

- Letter Width Locking File/File Pedestals
- Available with Veneer (W) or HPL (P) Top, Must Specify
- Fixed Storage Shelf Behind Doors
- Profiles on Three (3) Sides for Flush Wall Application Standard
- Flush Feature Available; Must Specify: Flush Left (FL), Flush Right (FR) or Flush Left and Right (FLR)
- Flush Option Reduces Unit by 3/4" Per Side and 1/2" for Both Flush Sides

**WARDROBE/STORAGE CABINET**

|  | Hinged Left | Hinged Right |    |                                 |                                |     |      |          |
|--|-------------|--------------|----|---------------------------------|--------------------------------|-----|------|----------|
|  | 21-1872WL   | 21-1872WR    | 18 | 20 <sup>7</sup> / <sub>16</sub> | 70 <sup>7</sup> / <sub>8</sub> | 152 | 19.2 | W\$ 2796 |

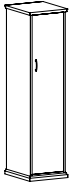

Shown as Right

Must Specify (in this order):

Model #  
Finish  
Pull  
Locking Doors  
Flush Feature

**Description**

- Coat Rod Under Top Fixed Shelf
- Three (3) Adjustable Shelves; Adjustable Shelves can be Removed for Wardrobe Application
- Profiles on Three (3) Sides for Flush Wall Application Standard
- Flush Feature Available; Must Specify: Flush Left (FL), Flush Right (FR) or Flush on Both Sides (FLR)
- Flush Option Reduces Unit by 3/4" Per Side and 1/2" if Both Sides Are Selected to be Flush
- Optional Locking Doors ([See Locking Options](#)), Lock Core will Coordinate with Pull Color

**DOUBLE WARDROBE/STORAGE**

|  |           |    |                                 |                                |     |      |          |
|--|-----------|----|---------------------------------|--------------------------------|-----|------|----------|
|  | 21-3672WC | 36 | 20 <sup>7</sup> / <sub>16</sub> | 70 <sup>7</sup> / <sub>8</sub> | 290 | 42.0 | W\$ 3883 |
|  | 21-3072WC | 30 | 20 <sup>7</sup> / <sub>16</sub> | 70 <sup>7</sup> / <sub>8</sub> | 240 | 35.7 | W\$ 3781 |

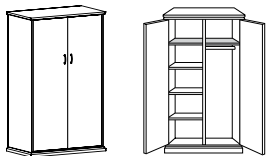

Must Specify (in this order):

Model #  
Finish  
Pull  
Locking Doors  
Flush Feature

**Description**

- Fixed Top Shelf Behind Each Door
- Three (3) Adjustable Shelves on Left Side; Coat Rod Under Fixed Shelf on Right Side
- Profiled on Three (3) Sides for Flush Wall Applications Standard
- Flush Feature Available; Must Specify: Flush Left (FL), Flush Right (FR) or Flush on Both Sides (FLR)
- Flush Option Reduces Unit by 3/4" Per Side and 1/2" if Both Sides Are Selected to be Flush
- Optional Locking Doors ([See Locking Options](#)), Lock Core will Coordinate with Pull Color

P = HPL W = Veneer

For ordering options, see overview at the beginning of this section.

Designers Jim Contois and Ramsey Madsen complement existing products with the Tri-One Table Collection. A full offering of training, meeting, and modular tables are available in flexible models that is sure to meet every expectation with integrated power and data capabilities.

**CONSTRUCTION**

**LAMINATE**

- Thermally-Fused Laminate (TFL) and High-Pressure Laminate (HPL) are made of woodgrain and solid color laminates fused to particleboard core; each laminate offers lasting beauty, superior resistance to normal wear, and easy maintenance

**VENEER**

- Surfaces feature select-grade, plain-sliced hardwood Cherry, Maple, American Black Walnut, White Oak, and composite veneers; Veneers are carefully selected and matched to assure proper balance and consistency
- Veneer features UVAdvantage, an ultra-violet finish, on all exposed surfaces by utilizing roll-coat UV technology

**TOPS**

- Tops with the Square (Y) edge profile are 1" thick TFL or 1 3/16" HPL with a 3mm PVC rim; or 1 3/16" Veneer with 1.5mm edge banding
- Tops with the Knife (K) edge profile are 1 3/16" HPL with a 3mm PVC rim or 1 3/16" Veneer with 1 1/2 mm edge banding
- Training and Modular tops feature shaped profiles on the user side while Meeting tops are shaped on all four sides
- Tops are pre-drilled for the specified base assembly and for ganging where applicable
- Grain direction runs left-to-right, unless noted



Knife (K)



Square (Y)

**LEGS/BASES**

- The Envy and Vantage leg/base styles are powder-coated Aluminum and include a 5mm steel mounting plate; Strut legs are made of steel and are powder-coated Aluminum or Black
- Envy style legs are aluminum extrusions while Vantage style legs are welded steel
- All legs and bases come standard with adjustable glides

**GANGING**

- All Modular and Training tops are pre-drilled with threaded inserts for ganging applications
- Ganging brackets include quick release thumb screws for ease of use; No tools required

**NESTING**

- Training tables offer an exclusive flip mechanism which can be accessed from any position to allow easier nesting of tables
- Optional flip mechanisms are factory installed and must be specified at the time of order

**POWER/DATA/CORD MANAGEMENT**

- Grommets are available in tops, where noted
- Grommets are 2 3/8" in diameter and available in black or silver
- Power/Data units available for under-surface mount, routed into tops, or for use in standard grommet holes (e.g., Sand Dollar)
- Power/Data Units comply with FCC Part 15A and UL
- Standard Power/Data plugs and daisy-chain connections are available; daisy chains are non-sequential; connect up to 8 modules

**HOW TO ORDER EXAMPLES**

| MODULAR TABLE      | QTY | MODEL NO.    | EXAMPLE |       |
|--------------------|-----|--------------|---------|-------|
| TOP                | 4   | 85-3084MCT   | Finish  | FO    |
| LEG                | 4   | 08-0227APL4  |         |       |
| GANGING            | 3   | 08-1505GB    |         |       |
| MODESTY            | 4   | 85-0884MD    | Finish  | FO    |
| GROMMET/POWER/DATA | 4   | 01-DUOBEZELS |         | PDC-L |

| FLEXIBLE SIZE TOP  | QTY | MODEL NO.    | EXAMPLE |    |
|--------------------|-----|--------------|---------|----|
| TOP                | 4   | 86-FLEXMCT30 | Width   | 79 |
|                    |     |              | Color   | WH |
| LEG                | 4   | 08-0227SPL4  |         |    |
| GANGING            | 3   | 08-1505GB    |         |    |
| MODESTY            |     | No Modesty   |         |    |
| GROMMET/POWER/DATA |     | No Grommet   |         |    |

| MEETING TABLE      | QTY | MODEL NO.    | EXAMPLE |     |
|--------------------|-----|--------------|---------|-----|
| TOP                | 1   | 86-4296MTKH  | Color   | WTA |
| LEG                | 1   | 08-2828YLG84 | Finish  | BLK |
| GROMMET/POWER/DATA | 1   | GC           | Color   | BLK |

| TRAINING TABLE     | QTY | MODEL NO.     | EXAMPLE |       |
|--------------------|-----|---------------|---------|-------|
| TOP                | 6   | 86-2472TTKH   | Color   | PTM   |
| LEG                | 6   | 08-2427TLC72  | Casters | SOFT  |
| GANGING            | 5   | 08-1505GB     |         |       |
| NESTING            | 6   | 08-FLIP       |         |       |
| MODESTY            | 6   | 86-0865HMD    | Color   | PTM   |
| GROMMET/POWER/DATA | 6   | 01-PDUOBEZELW |         | PDC-C |

**TFL (T) & HPL (P) LAMINATE OPTIONS**

*Tops with Knife Edge Profile available in HPL Only.*

**WOODGRAIN**

|     |                  |     |                     |
|-----|------------------|-----|---------------------|
| AS  | Asian Night      | PNW | Pinnacle Walnut     |
| BW  | Beigewood        | SCH | Select Cherry       |
| CO  | Columbian Walnut | SKC | Shaker Cherry       |
| EF  | Espresso         | SBP | Smoky Brown Pear    |
| GC  | Golden Cherry    | TK  | Studio Teak         |
| HVM | Harvest Maple    | SM  | Sugar Maple         |
| MW  | Mahogany Walnut  | WTA | Weathered Ash       |
| ORW | Oak Riftwood     | WC  | Williamsburg Cherry |

**SOLID**

|     |                |     |            |
|-----|----------------|-----|------------|
| BL  | Black          | PPD | Pepperdust |
| WH  | Designer White | SG  | Slate Grey |
| FHG | Fashion Grey   | WHS | White Sand |

**PATTERNED (HPL ONLY)**

|     |             |     |            |
|-----|-------------|-----|------------|
| PTM | Pewter Mesh | STM | Steel Mesh |
|-----|-------------|-----|------------|

### VENEER (W) OPTIONS

Veneer features UVAdvantage, an ultra-violet finish, on all exposed surfaces by utilizing roll-coat UV technology

|     |                    |     |                     |
|-----|--------------------|-----|---------------------|
| AW  | Artisan Walnut     | MW  | Mahogany Walnut     |
| AS  | Asian Night        | MO  | Medium Oak*         |
| CO  | Columbian Walnut   | ORW | Oak Riftwood*       |
| DC  | Dark Cherry        | SCH | Select Cherry       |
| DFW | Dark Forest Walnut | SKC | Shaker Cherry       |
| EF  | Espresso           | SBP | Smoky Brown Pear    |
| FO  | Fawn Oak*          | SM  | Sugar Maple         |
| GC  | Golden Cherry      | SW  | Sunglow Walnut      |
| HVM | Harvest Maple      | WTA | Weathered Ash*      |
| HW  | Harvest Walnut     | WC  | Williamsburg Cherry |
| LW  | Legacy Walnut      |     |                     |

\* Finish is Low Sheen

### GROMMET OPTIONS & POWER/DATA UNIT LOCATIONS

Grommets are available in modular, meeting, and training tops. Tops may also be ordered without grommets at no additional charge. Please specify NO GROMMET on order.

Power/Data units must be specified separately with surface mount location. Specify location on order, as well as the power/data unit. Routed for field placement at no additional charge.

Grommets are available in standard locations. Please specify using info below. Multiple locations may be selected. Only one grommet/power/data unit per location.

#### GROMMET LOCATIONS (Black = BLK and Silver = SLV)

|    |   |    |    |
|----|---|----|----|
| GC | Grommet, Center - Must Specify BLK or SLV | \$ | 72 |
| GL | Grommet, Left - Must Specify BLK or SLV   | \$ | 72 |
| GR | Grommet, Right - Must Specify BLK or SLV  | \$ | 72 |

#### DUO/TRIO BEZEL LOCATIONS (Starting on Page 200)

|       |               |
|-------|---------------|
| PDC-C | Bezel, Center |
| PDC-L | Bezel, Left   |
| PDC-R | Bezel, Right  |

Grommets and Power/Data Units may be ordered in non-standard locations. Call Customer Service to assist with specification and/or please attach a drawing to the PO showing the location of the grommet. Note additional charges and lead times may apply.

#### 24" Modular Tops

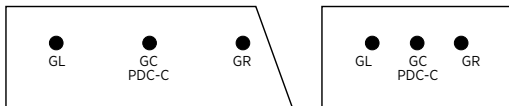

GL/GR: Located 10" from end based on widest dimension, 13 3/8" from user side  
GC/PDC-C: Located 13 3/8" from user side

#### 30" Modular Tops

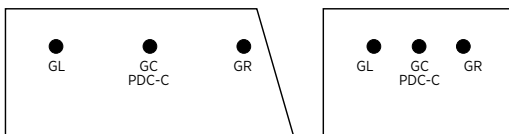

GL/GR: Located 10" from end based on widest dimension, 19 3/8" from user side  
GC/PDC-C: Located 19 3/8" from user side

#### Meeting Tops (Where Applicable)

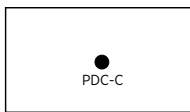

PDC-C: On Center, front to back

#### 18" Training Tables

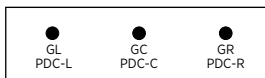

GL/GR/PDC-L/PDC-R: Located 10" from end, 12" from user side  
GC/PDC-C: Located 12" from user side

#### 24" Training Tables

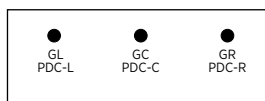

GL/GR: Located 10" from end, 16 1/2" from user side  
GC: Located 16 1/2" from user side

#### 30" Training Tables

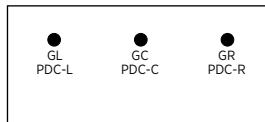

GL/GR: Located 10" from end, 20" from user side  
GC: Located 20" from user side

### CERTIFICATIONS & COMPLIANCE

- Intertek Sustainability Certified
- BIFMA level® Certified
- BIFMA Compliant® Certified
- TSCA Title VI (formerly CARB) Compliance
- US Green Building's LEED® Contribution



**Modular Tops & Legs**



Rectangular Modular Tops in Standard Sizes [\(See Details\)](#)  
Flexible Sizes [\(See Details\)](#)

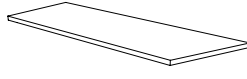

Trapezoid Modular Tops in Standard [\(See Multiple Unit Details\)](#)  
Flexible Sizes [\(See Multiple Unit Details\)](#)



Pentagon Ganging Tops [\(See Details\)](#)

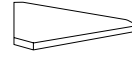

Bridge Ganging Tops [\(See Multiple Unit Details\)](#)



Envy Post Leg [\(See Details\)](#)



Vantage Post Leg [\(See Details\)](#)

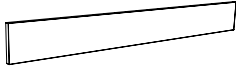

Modesty Panels [\(See Multiple Unit Details\)](#)

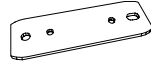

Ganging Brackets [\(See Details\)](#)



Grommets, Power/Data, and Accessories [\(See Multiple Unit Details\)](#)

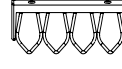

**Meeting Tops & Legs**



Rectangular Meeting Tops [\(See Details\)](#)



Soft Rectangular Meeting Tops [\(See Details\)](#)



Soft View Meeting Tops [\(See Details\)](#)



Ellipse Meeting Tops\* [\(See Details\)](#)

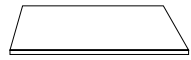

Square Meeting Tops [\(See Details\)](#)

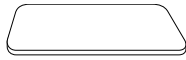

Soft Square Meeting Tops [\(See Details\)](#)



Round Meeting Tops [\(See Details\)](#)



Grommets, Power/Data, and Accessories [\(See Multiple Unit Details\)](#)

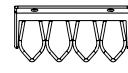
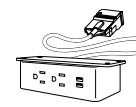

**Bases and Legs** [\(See Multiple Base Options\)](#)



Y-Bases [\(See Details\)](#)

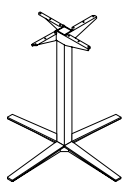

X-Bases [\(See Details\)](#)

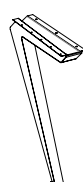

Strut Legs [\(See Details\)](#)

\* The Ellipse Meeting Tops will use the Envy Post or Vantage Post Legs

**Training Tops & Legs**

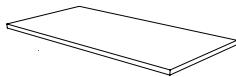

Rectangular Training Tops [\(See Details\)](#)

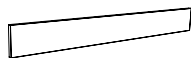

Modesty Panels [\(See Details\)](#)



Grommets, Power/Data, and Accessories [\(See Multiple Unit Details\)](#)

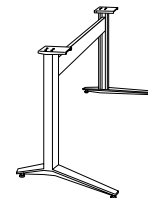
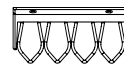

Envy C-Legs [\(See Details\)](#)

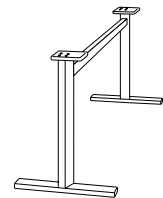

Vantage T-Legs [\(See Details\)](#)

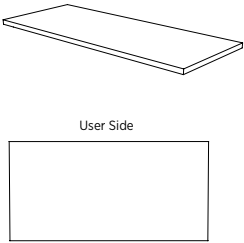
| Item   | Model No.          |              | W      | D  | H  | Ship Wt | Cubic Ft | List Price |          |
|--|--------------------|--------------|--------|----|----|---------|----------|------------|----------|
| <b>RECTANGULAR MODULAR TOPS</b>  |                    |              |        |    |    |         |          |            |          |
|  <p>User Side</p> | <b>Square Edge</b> |              |        |    |    |         |          |            |          |
|  | 86-3084MCT         | TFL          | 84     | 30 | -  | 76.4    | 6.0      | T\$ 951    |          |
|  | 86-3084MCTH        | HPL          |        |    |    |         |          | P\$ 1288   |          |
|  | 85-3084MCT         | Veneer       |        |    |    |         |          | W\$ 1908   |          |
|  | 86-3072MCT         | TFL          | 72     | 30 | -  | 65.5    | 5.1      | T\$ 768    |          |
|  | 86-3072MCTH        | HPL          |        |    |    |         |          | P\$ 1042   |          |
|  | 85-3072MCT         | Veneer       |        |    |    |         |          | W\$ 1545   |          |
|  | 86-3060MCT         | TFL          | 60     | 30 | -  | 54.6    | 4.3      | T\$ 692    |          |
|  | 86-3060MCTH        | HPL          |        |    |    |         |          | P\$ 937    |          |
|  | 85-3060MCT         | Veneer       |        |    |    |         |          | W\$ 1385   |          |
|  | 86-3048MCT         | TFL          | 48     | 30 | -  | 43.7    | 3.5      | T\$ 516    |          |
|  | 86-3048MCTH        | HPL          |        |    |    |         |          | P\$ 701    |          |
|  | 85-3048MCT         | Veneer       |        |    |    |         |          | W\$ 1039   |          |
|  | 86-2484MCT         | TFL          | 84     | 24 | -  | 61.1    | 4.9      | T\$ 882    |          |
|  | 86-2484MCTH        | HPL          |        |    |    |         |          | P\$ 1198   |          |
|  | 85-2484MCT         | Veneer       |        |    |    |         |          | W\$ 1772   |          |
|  | 86-2472MCT         | TFL          | 72     | 24 | -  | 52.4    | 4.2      | T\$ 711    |          |
|  | 86-2472MCTH        | HPL          |        |    |    |         |          | P\$ 962    |          |
|  | 85-2472MCT         | Veneer       |        |    |    |         |          | W\$ 1424   |          |
|  | 86-2460MCT         | TFL          | 60     | 24 | -  | 43.7    | 3.5      | T\$ 648    |          |
|  | 86-2460MCTH        | HPL          |        |    |    |         |          | P\$ 874    |          |
|  | 85-2460MCT         | Veneer       |        |    |    |         |          | W\$ 1293   |          |
|  | 86-2448MCT         | TFL          | 48     | 24 | -  | 34.9    | 2.8      | T\$ 479    |          |
|  | 86-2448MCTH        | HPL          |        |    |    |         |          | P\$ 650    |          |
|  | 85-2448MCT         | Veneer       |        |    |    |         |          | W\$ 959    |          |
|  | <b>Knife Edge</b>  |              |        |    |    |         |          |            |          |
|  |                    | 86-3084MCTKH | HPL    | 84 | 30 | -       | 76.4     | 6.0        | P\$ 1686 |
|  |                    | 85-3084MCTK  | Veneer |    |    |         |          |            | W\$ 2325 |
|  | 86-3072MCTKH       | HPL          | 72     | 30 | -  | 65.5    | 5.1      | P\$ 1367   |          |
|  | 85-3072MCTK        | Veneer       |        |    |    |         |          | W\$ 1883   |          |
|  | 86-3060MCTKH       | HPL          | 60     | 30 | -  | 54.6    | 4.3      | P\$ 1228   |          |
|  | 85-3060MCTK        | Veneer       |        |    |    |         |          | W\$ 1692   |          |
|  | 86-3048MCTKH       | HPL          | 48     | 30 | -  | 43.7    | 3.5      | P\$ 919    |          |
|  | 85-3048MCTK        | Veneer       |        |    |    |         |          | W\$ 1268   |          |
|  | 86-2484MCTKH       | HPL          | 84     | 24 | -  | 61.1    | 4.9      | P\$ 1571   |          |
|  | 85-2484MCTK        | Veneer       |        |    |    |         |          | W\$ 2160   |          |
|  | 86-2472MCTKH       | HPL          | 72     | 24 | -  | 52.4    | 4.2      | P\$ 1262   |          |
|  | 85-2472MCTK        | Veneer       |        |    |    |         |          | W\$ 1740   |          |
|  | 86-2460MCTKH       | HPL          | 60     | 24 | -  | 43.7    | 3.5      | P\$ 1144   |          |
|  | 85-2460MCTK        | Veneer       |        |    |    |         |          | W\$ 1577   |          |
|  | 86-2448MCTKH       | HPL          | 48     | 24 | -  | 34.9    | 2.8      | P\$ 847    |          |
|  | 85-2448MCTK        | Veneer       |        |    |    |         |          | W\$ 1170   |          |



Must Order Envy or Vantage Post Legs. [See Leg Options.](#)

**Description**

- Profile on User Side Only
- Flexible Sizes Available, [See Next Page](#)
- Tops 60" or Larger Include Stiffener Bar
- Legs Required (Assembly Required); Sold Separately, [See Leg Options](#)
- Pre-Drilled for Optional Ganging Brackets; Sold Separately, [See Details](#)
- Fixed Modesty Panel Options Available; Sold Separately, [See Modesty Options](#)
- Power & Data Options Available; Sold Separately, [See Multiple Units](#) and [See Locations](#)

T = TFL P = HPL W = Veneer

[See Tri-One Overview For Ordering Options](#)

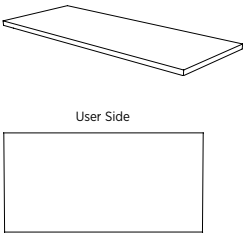
| Item  | Model No.          |               | W     | D     | H  | Ship Wt | Cubic Ft | List Price |          |
|---|--------------------|---------------|-------|-------|----|---------|----------|------------|----------|
| <b>RECTANGULAR MODULAR TOPS</b><br><b>FLEXIBLE SIZES</b><br> | <b>Square Edge</b> |               |       |       |    |         |          |            |          |
|   | 86-FLEXMCT30       | TFL           | 84-73 | 30    | -  | 76.4    | 6.0      | T\$ 951    |          |
|   | 86-FLEXMCTH30      | HPL           |       |       |    |         |          | P\$ 1288   |          |
|   | 85-FLEXMCT30       | Veneer        |       |       |    |         |          | W\$ 1908   |          |
|   |                    |               | 72-61 | 30    | -  | 65.5    | 5.1      | T\$ 768    |          |
|   |                    |               |       |       |    |         |          | P\$ 1042   |          |
|   |                    |               |       |       |    |         |          | W\$ 1545   |          |
|   |                    |               | 60-49 | 30    | -  | 54.6    | 4.3      | T\$ 692    |          |
|   |                    |               |       |       |    |         |          | P\$ 937    |          |
|   |                    |               |       |       |    |         |          | W\$ 1385   |          |
|   |                    |               | 48-36 | 30    | -  | 43.7    | 3.5      | T\$ 516    |          |
|   |                    |               |       |       |    |         |          | P\$ 701    |          |
|   |                    |               |       |       |    |         |          | W\$ 1039   |          |
|   |                    | 86-FLEXMCT24  | TFL   | 84-73 | 24 | -       | 61.1     | 4.9        | T\$ 882  |
|   |                    | 86-FLEXMCTH24 | HPL   |       |    |         |          |            | P\$ 1198 |
|   | 85-FLEXMCT24       | Veneer        |       |       |    |         |          | W\$ 1772   |          |
|   |                    |               | 72-61 | 24    | -  | 52.4    | 4.2      | T\$ 711    |          |
|   |                    |               |       |       |    |         |          | P\$ 962    |          |
|   |                    |               |       |       |    |         |          | W\$ 1424   |          |
|   |                    |               | 60-49 | 24    | -  | 43.7    | 3.5      | T\$ 648    |          |
|   |                    |               |       |       |    |         |          | P\$ 874    |          |
|   |                    |               |       |       |    |         |          | W\$ 1293   |          |
|   |                    |               | 48-36 | 24    | -  | 34.9    | 2.8      | T\$ 479    |          |
|   |                    |               |       |       |    |         |          | P\$ 650    |          |
|   |                    |               |       |       |    |         |          | W\$ 959    |          |
|   | <b>Knife Edge</b>  |               |       |       |    |         |          |            |          |
|   | 86-FLEXMCTKH30     | HPL           | 84-73 | 30    | -  | 76.4    | 6.0      | P\$ 1686   |          |
|   | 85-FLEXMCTK30      | Veneer        |       |       |    |         |          | W\$ 2325   |          |
|   |                    |               | 72-61 | 30    | -  | 65.5    | 5.1      | P\$ 1367   |          |
|   |                    |               |       |       |    |         |          | W\$ 1883   |          |
|   |                    |               | 60-49 | 30    | -  | 54.6    | 4.3      | P\$ 1228   |          |
|   |                    |               |       |       |    |         |          | W\$ 1692   |          |
|   |                    |               | 48-36 | 30    | -  | 43.7    | 3.5      | P\$ 919    |          |
|   |                    |               |       |       |    |         |          | W\$ 1268   |          |
|   | 86-FLEXMCTKH24     | HPL           | 84-73 | 24    | -  | 61.1    | 4.9      | P\$ 1571   |          |
|   | 85-FLEXMCTK24      | Veneer        |       |       |    |         |          | W\$ 2160   |          |
|   |                    |               | 72-61 | 24    | -  | 52.4    | 4.2      | P\$ 1262   |          |
|   |                    |               |       |       |    |         |          | W\$ 1740   |          |
|   |                    |               | 60-49 | 24    | -  | 43.7    | 3.5      | P\$ 1144   |          |
|   |                    |               |       |       |    |         |          | W\$ 1577   |          |
|   |                    |               | 48-36 | 24    | -  | 34.9    | 2.8      | P\$ 847    |          |
|   |                    |               |       |       |    |         |          | W\$ 1170   |          |

Must Specify (in this order):  
 Model #  
 Top Width Measurement  
 Top Finish/Color  
 Leg Model #  
 Ganging Brackets  
 Modesty Model # and Finish/Color  
 Grommet/Power/Data Location

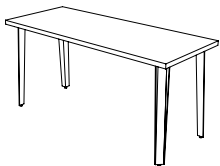

**Must Order Envy or Vantage Post Legs. See Leg Options.**

**Description**

- Profile on User Side Only
- Must Specify Width In One Inch Increments from 36" to 84"
- Tops 60" or Larger Include Stiffener Bar
- Legs Required (Assembly Required); Sold Separately, [See Leg Options](#)
- Pre-Drilled for Optional Ganging Brackets; Sold Separately, [See Details](#)
- Fixed Modesty Panel Options Available; Sold Separately, [See Modesty Options](#)
- Power & Data Options Available; Sold Separately, [See Multiple Units](#) and [See Locations](#)

T = TFL P = HPL W = Veneer

[See Tri-One Overview For Ordering Options](#)

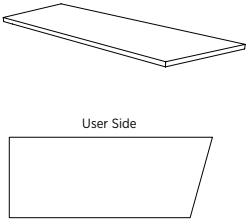
| Item   | Model No.     |        | W  | D  | H    | Ship Wt | Cubic Ft | List Price |
|--|---------------|--------|----|----|------|---------|----------|------------|
| <b>LEFT TRAPEZOID MODULAR TOPS</b>   |               |        |    |    |      |         |          |            |
| <b>Square Edge</b>   |               |        |    |    |      |         |          |            |
|  <p>User Side</p> | 86-3084LMCT   | TFL    | 84 | 30 | -    | 76.4    | 6.0      | T\$ 914    |
|  | 86-3084LMCTH  | HPL    |    |    |      |         |          | P\$ 1237   |
|  | 85-3084LMCT   | Veneer |    |    |      |         |          | W\$ 1831   |
|  | 86-3072LMCT   | TFL    | 72 | 30 | -    | 65.5    | 5.1      | T\$ 739    |
|  | 86-3072LMCTH  | HPL    |    |    |      |         |          | P\$ 1000   |
|  | 85-3072LMCT   | Veneer |    |    |      |         |          | W\$ 1480   |
|  | 86-3060LMCT   | TFL    | 60 | 30 | -    | 54.6    | 4.3      | T\$ 664    |
|  | 86-3060LMCTH  | HPL    |    |    |      |         |          | P\$ 902    |
|  | 85-3060LMCT   | Veneer |    |    |      |         |          | W\$ 1334   |
|  | 86-3048LMCT   | TFL    | 48 | 30 | -    | 43.7    | 3.5      | T\$ 497    |
|  | 86-3048LMCTH  | HPL    |    |    |      |         |          | P\$ 674    |
|  | 85-3048LMCT   | Veneer |    |    |      |         |          | W\$ 996    |
|  | 86-2484LMCT   | TFL    | 84 | 24 | -    | 61.1    | 4.9      | T\$ 847    |
|  | 86-2484LMCTH  | HPL    |    |    |      |         |          | P\$ 1152   |
|  | 85-2484LMCT   | Veneer |    |    |      |         |          | W\$ 1706   |
|  | 86-2472LMCT   | TFL    | 72 | 24 | -    | 52.4    | 4.2      | T\$ 680    |
|  | 86-2472LMCTH  | HPL    |    |    |      |         |          | P\$ 922    |
|  | 85-2472LMCT   | Veneer |    |    |      |         |          | W\$ 1366   |
| 86-2460LMCT  | TFL           | 60     | 24 | -  | 43.7 | 3.5     | T\$ 620  |            |
| 86-2460LMCTH   | HPL           |        |    |    |      |         | P\$ 839  |            |
| 85-2460LMCT  | Veneer        |        |    |    |      |         | W\$ 1245 |            |
| 86-2448LMCT  | TFL           | 48     | 24 | -  | 34.9 | 2.8     | T\$ 456  |            |
| 86-2448LMCTH   | HPL           |        |    |    |      |         | P\$ 618  |            |
| 85-2448LMCT  | Veneer        |        |    |    |      |         | W\$ 916  |            |
| <b>Knife Edge</b>  |               |        |    |    |      |         |          |            |
|  | 86-3084LMCTKH | HPL    | 84 | 30 | -    | 76.4    | 6.0      | P\$ 1622   |
|  | 85-3084LMCTK  | Veneer |    |    |      |         |          | W\$ 2235   |
|  | 86-3072LMCTKH | HPL    | 72 | 30 | -    | 65.5    | 5.1      | P\$ 1309   |
|  | 85-3072LMCTK  | Veneer |    |    |      |         |          | W\$ 1805   |
|  | 86-3060LMCTKH | HPL    | 60 | 30 | -    | 54.6    | 4.3      | P\$ 1180   |
|  | 85-3060LMCTK  | Veneer |    |    |      |         |          | W\$ 1626   |
|  | 86-3048LMCTKH | HPL    | 48 | 30 | -    | 43.7    | 3.5      | P\$ 881    |
|  | 85-3048LMCTK  | Veneer |    |    |      |         |          | W\$ 1214   |
|  | 86-2484LMCTKH | HPL    | 84 | 24 | -    | 61.1    | 4.9      | P\$ 1506   |
|  | 85-2484LMCTK  | Veneer |    |    |      |         |          | W\$ 2078   |
|  | 86-2472LMCTKH | HPL    | 72 | 24 | -    | 52.4    | 4.2      | P\$ 1210   |
|  | 85-2472LMCTK  | Veneer |    |    |      |         |          | W\$ 1667   |
|  | 86-2460LMCTKH | HPL    | 60 | 24 | -    | 43.7    | 3.5      | P\$ 1100   |
|  | 85-2460LMCTK  | Veneer |    |    |      |         |          | W\$ 1517   |
|  | 86-2448LMCTKH | HPL    | 48 | 24 | -    | 34.9    | 2.8      | P\$ 811    |
|  | 85-2448LMCTK  | Veneer |    |    |      |         |          | W\$ 1118   |

Must Specify (in this order):  
 Model #  
 Top Finish/Color  
 Leg Model #  
 Ganging Brackets  
 Modesty Model # and Finish/Color  
 Grommet/Power/Data Location

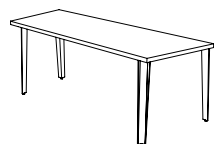

Must Order Envy or Vantage Post Legs. [See Leg Options.](#)

**Description**

- Profile on User Side Only
- Flexible Sizes Available, [See Next Page](#)
- Tops 60" or Larger Include Stiffener Bar
- Legs Required (Assembly Required); Sold Separately, [See Leg Options](#)
- Pre-Drilled for Optional Ganging Brackets; Sold Separately, [See Details](#)
- Fixed Modesty Panel Options Available; Sold Separately, [See Modesty Options](#)
- Power & Data Options Available; Sold Separately, [See Multiple Units](#) and [See Locations](#)

T = TFL P = HPL W = Veneer

[See Tri-One Overview For Ordering Options](#)

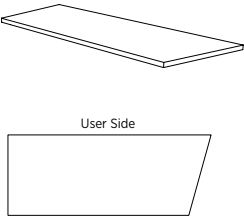
| Item   | Model No.          |                | W     | D     | H  | Ship Wt | Cubic Ft | List Price |          |
|--|--------------------|----------------|-------|-------|----|---------|----------|------------|----------|
| <b>LEFT TRAPEZOID MODULAR TOPS</b><br><b>FLEXIBLE SIZES</b><br> | <b>Square Edge</b> |                |       |       |    |         |          |            |          |
|  | 86-FLEXLMCT30      | TFL            | 84-73 | 30    | -  | 76.4    | 6.0      | T\$ 914    |          |
|  | 86-FLEXLMCTH30     | HPL            |       |       |    |         |          | P\$ 1237   |          |
|  | 85-FLEXLMCT30      | Veneer         |       |       |    |         |          | W\$ 1831   |          |
|  |                    |                | 72-61 | 30    | -  | 65.5    | 5.1      | T\$ 739    |          |
|  |                    |                |       |       |    |         |          | P\$ 1000   |          |
|  |                    |                |       |       |    |         |          | W\$ 1480   |          |
|  |                    |                | 60-49 | 30    | -  | 54.6    | 4.3      | T\$ 664    |          |
|  |                    |                |       |       |    |         |          | P\$ 902    |          |
|  |                    |                |       |       |    |         |          | W\$ 1334   |          |
|  |                    |                | 48-36 | 30    | -  | 43.7    | 3.5      | T\$ 497    |          |
|  |                    |                |       |       |    |         |          | P\$ 674    |          |
|  |                    |                |       |       |    |         |          | W\$ 996    |          |
|  |                    | 86-FLEXLMCT24  | TFL   | 84-73 | 24 | -       | 61.1     | 4.9        | T\$ 847  |
|  |                    | 86-FLEXLMCTH24 | HPL   |       |    |         |          |            | P\$ 1152 |
|  | 85-FLEXLMCT24      | Veneer         |       |       |    |         |          | W\$ 916    |          |
|  |                    |                | 72-61 | 24    | -  | 52.4    | 4.2      | T\$ 680    |          |
|  |                    |                |       |       |    |         |          | P\$ 922    |          |
|  |                    |                |       |       |    |         |          | W\$ 1366   |          |
|  |                    |                | 60-49 | 24    | -  | 43.7    | 3.5      | T\$ 620    |          |
|  |                    |                |       |       |    |         |          | P\$ 839    |          |
|  |                    |                |       |       |    |         |          | W\$ 1245   |          |
|  |                    |                | 48-36 | 24    | -  | 34.9    | 2.8      | T\$ 456    |          |
|  |                    |                |       |       |    |         |          | P\$ 618    |          |
|  |                    |                |       |       |    |         |          | W\$ 916    |          |
|  | <b>Knife Edge</b>  |                |       |       |    |         |          |            |          |
|  | 86-FLEXLMCTKH30    | HPL            | 84-73 | 30    | -  | 76.4    | 6.0      | P\$ 1622   |          |
|  | 85-FLEXLMCTK30     | Veneer         |       |       |    |         |          | W\$ 2235   |          |
|  |                    |                | 72-61 | 30    | -  | 65.5    | 5.1      | P\$ 1309   |          |
|  |                    |                |       |       |    |         |          | W\$ 1805   |          |
|  |                    |                | 60-49 | 30    | -  | 54.6    | 4.3      | P\$ 1180   |          |
|  |                    |                |       |       |    |         |          | W\$ 1626   |          |
|  |                    |                | 48-36 | 30    | -  | 43.7    | 3.5      | P\$ 881    |          |
|  |                    |                |       |       |    |         |          | W\$ 1214   |          |
|  | 86-FLEXLMCTKH24    | HPL            | 84-73 | 24    | -  | 61.1    | 4.9      | P\$ 1506   |          |
|  | 85-FLEXLMCTK24     | Veneer         |       |       |    |         |          | W\$ 2078   |          |
|  |                    |                | 72-61 | 24    | -  | 52.4    | 4.2      | P\$ 1210   |          |
|  |                    |                |       |       |    |         |          | W\$ 1667   |          |
|  |                    |                | 60-49 | 24    | -  | 43.7    | 3.5      | P\$ 1100   |          |
|  |                    |                |       |       |    |         |          | W\$ 1517   |          |
|  |                    |                | 48-36 | 24    | -  | 34.9    | 2.8      | P\$ 811    |          |
|  |                    |                |       |       |    |         |          | W\$ 1118   |          |

Must Specify (in this order):  
 Model #  
 Top Width Measurement  
 Top Finish/Color  
 Leg Model #  
 Ganging Brackets  
 Modesty Model # and Finish/Color  
 Grommet/Power/Data Location

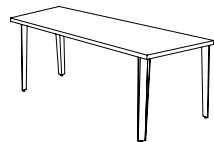

**Must Order Envy or Vantage Post Legs. See Leg Options.**

**Description**

- Profile on User Side Only
- Tops 60" or Larger Include Stiffener Bar
- Legs Required (Assembly Required); Sold Separately, [See Leg Options](#)
- Pre-Drilled for Optional Ganging Brackets; Sold Separately, [See Details](#)
- Fixed Modesty Panel Options Available; Sold Separately, [See Modesty Options](#)
- Power & Data Options Available; Sold Separately, [See Multiple Units](#) and [See Locations](#)

T = TFL P = HPL W = Veneer

[See Tri-One Overview For Ordering Options](#)

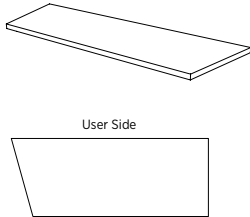
| Item   | Model No.     |        | W  | D  | H    | Ship Wt | Cubic Ft | List Price |
|--|---------------|--------|----|----|------|---------|----------|------------|
| <b>RIGHT TRAPEZOID MODULAR TOPS</b>  |               |        |    |    |      |         |          |            |
| <b>Square Edge</b>   |               |        |    |    |      |         |          |            |
|  <p>User Side</p> | 86-3084RMCT   | TFL    | 84 | 30 | -    | 76.4    | 6.0      | T\$ 914    |
|  | 86-3084RMCTH  | HPL    |    |    |      |         |          | P\$ 1237   |
|  | 85-3084RMCT   | Veneer |    |    |      |         |          | W\$ 1831   |
|  | 86-3072RMCT   | TFL    | 72 | 30 | -    | 65.5    | 5.1      | T\$ 739    |
|  | 86-3072RMCTH  | HPL    |    |    |      |         |          | P\$ 1000   |
|  | 85-3072RMCT   | Veneer |    |    |      |         |          | W\$ 1480   |
|  | 86-3060RMCT   | TFL    | 60 | 30 | -    | 54.6    | 4.3      | T\$ 664    |
|  | 86-3060RMCTH  | HPL    |    |    |      |         |          | P\$ 902    |
|  | 85-3060RMCT   | Veneer |    |    |      |         |          | W\$ 1334   |
|  | 86-3048RMCT   | TFL    | 48 | 30 | -    | 43.7    | 3.5      | T\$ 497    |
|  | 86-3048RMCTH  | HPL    |    |    |      |         |          | P\$ 674    |
|  | 85-3048RMCT   | Veneer |    |    |      |         |          | W\$ 996    |
|  | 86-2484RMCT   | TFL    | 84 | 24 | -    | 61.1    | 4.9      | T\$ 847    |
|  | 86-2484RMCTH  | HPL    |    |    |      |         |          | P\$ 1152   |
|  | 85-2484RMCT   | Veneer |    |    |      |         |          | W\$ 1706   |
|  | 86-2472RMCT   | TFL    | 72 | 24 | -    | 52.4    | 4.2      | T\$ 680    |
|  | 86-2472RMCTH  | HPL    |    |    |      |         |          | P\$ 922    |
|  | 85-2472RMCT   | Veneer |    |    |      |         |          | W\$ 1366   |
| 86-2460RMCT  | TFL           | 60     | 24 | -  | 43.7 | 3.5     | T\$ 620  |            |
| 86-2460RMCTH   | HPL           |        |    |    |      |         | P\$ 839  |            |
| 85-2460RMCT  | Veneer        |        |    |    |      |         | W\$ 1245 |            |
| 86-2448RMCT  | TFL           | 48     | 24 | -  | 34.9 | 2.8     | T\$ 456  |            |
| 86-2448RMCTH   | HPL           |        |    |    |      |         | P\$ 618  |            |
| 85-2448RMCT  | Veneer        |        |    |    |      |         | W\$ 916  |            |
| <b>Knife Edge</b>  |               |        |    |    |      |         |          |            |
|  | 86-3084RMCTKH | HPL    | 84 | 30 | -    | 76.4    | 6.0      | P\$ 1622   |
|  | 85-3084RMCTK  | Veneer |    |    |      |         |          | W\$ 2235   |
|  | 86-3072RMCTKH | HPL    | 72 | 30 | -    | 65.5    | 5.1      | P\$ 1309   |
|  | 85-3072RMCTK  | Veneer |    |    |      |         |          | W\$ 1805   |
|  | 86-3060RMCTKH | HPL    | 60 | 30 | -    | 54.6    | 4.3      | P\$ 1180   |
|  | 85-3060RMCTK  | Veneer |    |    |      |         |          | W\$ 1626   |
|  | 86-3048RMCTKH | HPL    | 48 | 30 | -    | 43.7    | 3.5      | P\$ 881    |
|  | 85-3048RMCTK  | Veneer |    |    |      |         |          | W\$ 1214   |
|  | 86-2484RMCTKH | HPL    | 84 | 24 | -    | 61.1    | 4.9      | P\$ 1506   |
|  | 85-2484RMCTK  | Veneer |    |    |      |         |          | W\$ 2078   |
|  | 86-2472RMCTKH | HPL    | 72 | 24 | -    | 52.4    | 4.2      | P\$ 1210   |
|  | 85-2472RMCTK  | Veneer |    |    |      |         |          | W\$ 1667   |
|  | 86-2460RMCTKH | HPL    | 60 | 24 | -    | 43.7    | 3.5      | P\$ 1100   |
|  | 85-2460RMCTK  | Veneer |    |    |      |         |          | W\$ 1517   |
|  | 86-2448RMCTKH | HPL    | 48 | 24 | -    | 34.9    | 2.8      | P\$ 811    |
|  | 85-2448RMCTK  | Veneer |    |    |      |         |          | W\$ 1118   |

Must Specify (in this order):  
 Model #  
 Top Finish/Color  
 Leg Model #  
 Ganging Brackets  
 Modesty Model # and Finish/Color  
 Grommet/Power/Data Location

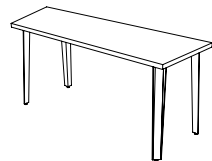

Must Order Envy or Vantage Post Legs. [See Leg Options.](#)

**Description**

- Profile on User Side Only
- Flexible Sizes Available, [See Next Page](#)
- Tops 60" or Larger Include Stiffener Bar
- Legs Required (Assembly Required); Sold Separately, [See Leg Options](#)
- Pre-Drilled for Optional Ganging Brackets; Sold Separately, [See Details](#)
- Fixed Modesty Panel Options Available; Sold Separately, [See Modesty Options](#)
- Power & Data Options Available; Sold Separately, [See Multiple Units](#) and [See Locations](#)

T = TFL P = HPL W = Veneer

[See Tri-One Overview For Ordering Options](#)

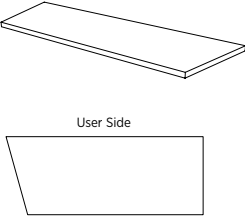
| Item  | Model No.       |        | W     | D     | H  | Ship Wt | Cubic Ft | List Price |          |
|---|-----------------|--------|-------|-------|----|---------|----------|------------|----------|
| <b>RIGHT TRAPEZOID MODULAR TOPS</b>   |                 |        |       |       |    |         |          |            |          |
| <b>FLEXIBLE SIZES</b>   |                 |        |       |       |    |         |          |            |          |
| <b>Square Edge</b>  |                 |        |       |       |    |         |          |            |          |
|  | 86-FLEXRMCT30   | TFL    | 84-73 | 30    | -  | 76.4    | 6.0      | T\$ 914    |          |
|   | 86-FLEXRMCTH30  | HPL    |       |       |    |         |          | P\$ 1237   |          |
|   | 85-FLEXRMCT30   | Veneer |       |       |    |         |          | W\$ 1831   |          |
|   |                 |        |       | 72-61 | 30 | -       | 65.5     | 5.1        | T\$ 739  |
|   |                 |        |       |       |    |         |          |            | P\$ 1000 |
|   |                 |        |       |       |    |         |          |            | W\$ 1480 |
|   |                 |        |       | 60-49 | 30 | -       | 54.6     | 4.3        | T\$ 664  |
|   |                 |        |       |       |    |         |          |            | P\$ 902  |
|   |                 |        |       |       |    |         |          |            | W\$ 1334 |
|   |                 |        |       | 48-36 | 30 | -       | 43.7     | 3.5        | T\$ 497  |
|   |                 |        |       |       |    |         |          |            | P\$ 674  |
|   |                 |        |       |       |    |         |          |            | W\$ 996  |
| <b>Knife Edge</b>   |                 |        |       |       |    |         |          |            |          |
|   | 86-FLEXRMCTK30  | HPL    | 84-73 | 30    | -  | 76.4    | 6.0      | P\$ 1622   |          |
|   | 85-FLEXRMCTK30  | Veneer |       |       |    |         |          | W\$ 2235   |          |
|   |                 |        | 72-61 | 30    | -  | 65.5    | 5.1      | P\$ 1309   |          |
|   |                 |        |       |       |    |         |          | W\$ 1805   |          |
|   |                 |        | 60-49 | 30    | -  | 54.6    | 4.3      | P\$ 1180   |          |
|   |                 |        |       |       |    |         |          | W\$ 1626   |          |
|   |                 |        | 48-36 | 30    | -  | 43.7    | 3.5      | P\$ 881    |          |
|   |                 |        |       |       |    |         |          | W\$ 1214   |          |
|   | 86-FLEXRMCTKH24 | HPL    | 84-73 | 24    | -  | 61.1    | 4.9      | P\$ 1506   |          |
|   | 85-FLEXRMCTK24  | Veneer |       |       |    |         |          | W\$ 2078   |          |
|   |                 |        | 72-61 | 24    | -  | 52.4    | 4.2      | P\$ 1210   |          |
|   |                 |        |       |       |    |         |          | W\$ 1667   |          |
|   |                 |        | 60-49 | 24    | -  | 43.7    | 3.5      | P\$ 1100   |          |
|   |                 |        |       |       |    |         |          | W\$ 1517   |          |
|   |                 |        | 48-36 | 24    | -  | 34.9    | 2.8      | P\$ 811    |          |
|   |                 |        |       |       |    |         |          | W\$ 1118   |          |

Must Specify (in this order):  
 Model #  
 Top Width Measurement  
 Top Finish/Color  
 Ganging Brackets  
 Ganging Model #  
 Modesty Model # and Finish/Color  
 Grommet/Power/Data Location

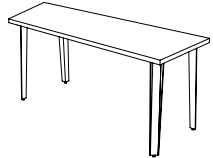

**Must Order Envy or Vantage Post Legs. [See Leg Options.](#)**

**Description**

- Profile on User Side Only
- Tops 60" or Larger Include Stiffener Bar
- Legs Required (Assembly Required); Sold Separately, [See Leg Options](#)
- Pre-Drilled for Optional Ganging Brackets; Sold Separately, [See Details](#)
- Fixed Modesty Panel Options Available; Sold Separately, [See Modesty Options](#)
- Power & Data Options Available; Sold Separately, [See Multiple Units](#) and [See Locations](#)

T = TFL P = HPL W = Veneer

[See Tri-One Overview For Ordering Options](#)

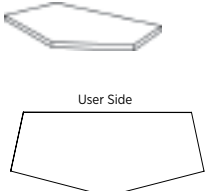
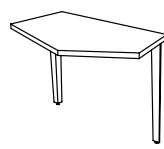
| Item   | Model No.  |        | W      | D      | H | Ship Wt | Cubic Ft | List Price |      |  |
|--|--|--------|--------|--------|---|---------|----------|------------|------|--|
| <b>PENTAGON MODULAR TOPS</b><br><br><br><br>User Side<br><br>Must Specify (in this order):<br>Model #<br>Top Finish/Color<br>Leg Model #<br>Ganging Brackets<br><br><br><br>Must Order Envy or Vantage Post Legs. <a href="#">See Leg Options.</a> | <b>Square Edge</b>                               |        |        |        |   |         |          |            |      |  |
|  | <i>For Use with 30"D Modular Tops:</i>           |        |        |        |   |         |          |            |      |  |
|  | 86-30MCTP  | TFL    | 58-48% | 18-25  | - | 44      | 3.6      | T\$        | 581  |  |
|  | 86-30MCTPH                                       | HPL    |        |        |   |         |          | P\$        | 785  |  |
|  | 85-30MCTP  | Veneer |        |        |   |         |          | W\$        | 1163 |  |
|  | <i>For Use with 24"D Modular Tops:</i>           |        |        |        |   |         |          |            |      |  |
|  | 86-24MCTP  | TFL    | 46½-37 | 18-23½ | - | 33.7    | 3.6      | T\$        | 512  |  |
|  | 86-24MCTPH                                       | HPL    |        |        |   |         |          | P\$        | 693  |  |
|  | 85-24MCTP  | Veneer |        |        |   |         |          | W\$        | 1027 |  |
|  | <b>Knife Edge</b>                                |        |        |        |   |         |          |            |      |  |
|  | <i>For Use with 30"D Modular Tops:</i>           |        |        |        |   |         |          |            |      |  |
|  | 86-30MCTPKH                                      | HPL    | 58-48% | 18-25  | - | 44      | 3.6      | P\$        | 1031 |  |
|  | 85-30MCTPK                                       | Veneer |        |        |   |         |          | W\$        | 1416 |  |
|  | <i>For Use with 24"D Modular Tops:</i>           |        |        |        |   |         |          |            |      |  |
|  | 86-24MCTPKH                                      | HPL    | 46½-37 | 18-23½ | - | 33.7    | 3.6      | P\$        | 906  |  |
| 85-24MCTPK   | Veneer   |        |        |        |   |         | W\$      | 1251       |      |  |
| <b>Description</b>   |  |        |        |        |   |         |          |            |      |  |
| <ul style="list-style-type: none"> <li>• Profile on User Side Only</li> <li>• Not a Freestanding Unit</li> <li>• Legs Required (Assembly Required); <a href="#">See Leg Options</a></li> <li>• 24" Tops Require Set of 2 Legs; 30" Tops Require Set of 4 Legs</li> <li>• Pre-Drilled for Required Ganging Brackets</li> </ul>  |  |        |        |        |   |         |          |            |      |  |
| <b>Specify &amp; Add: Ganging Brackets - Requires 2 Sets</b>   |  |        |        |        |   |         |          |            |      |  |
| 08-1505GB  | Ganging Bracket Kit - Set of 2 with Thumb Screws |        |        |        |   |         |          | \$         | 77   |  |

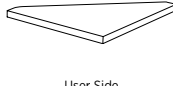
|  |  |        |     |    |   |      |     |      |      |  |
|--|--|--------|-----|----|---|------|-----|------|------|--|
| <b>90° BRIDGE MODULAR TOPS</b><br><br><br><br>User Side<br><br>Must Specify (in this order):<br>Model #<br>Top Finish/Color<br>Ganging Brackets | <b>Square Edge</b>                               |        |     |    |   |      |     |      |      |  |
|  | <i>For Use with 30"D Modular Tops:</i>           |        |     |    |   |      |     |      |      |  |
|  | 86-3090MCTB                                      | TFL    | 42% | 30 | - | 18.2 | 2.0 | T\$  | 649  |  |
|  | 86-3090MCTBH                                     | HPL    |     |    |   |      |     | P\$  | 876  |  |
|  | 85-3090MCTB                                      | Veneer |     |    |   |      |     | W\$  | 1296 |  |
|  | <i>For Use with 24"D Modular Tops:</i>           |        |     |    |   |      |     |      |      |  |
|  | 86-2490MCTB                                      | TFL    | 34  | 24 | - | 11.6 | 1.3 | T\$  | 456  |  |
|  | 86-2490MCTBH                                     | HPL    |     |    |   |      |     | P\$  | 618  |  |
|  | 85-2490MCTB                                      | Veneer |     |    |   |      |     | W\$  | 916  |  |
|  | <b>Knife Edge</b>                                |        |     |    |   |      |     |      |      |  |
|  | <i>For Use with 30"D Modular Tops:</i>           |        |     |    |   |      |     |      |      |  |
|  | 86-3090MCTBKH                                    | HPL    | 42% | 30 | - | 18.2 | 2.0 | P\$  | 1148 |  |
|  | 85-3090MCTBK                                     | Veneer |     |    |   |      |     | W\$  | 1582 |  |
|  | <i>For Use with 24"D Modular Tops:</i>           |        |     |    |   |      |     |      |      |  |
|  | 86-2490MCTBKH                                    | HPL    | 34  | 24 | - | 11.6 | 1.3 | P\$  | 811  |  |
| 85-2490MCTBK   | Veneer   |        |     |    |   |      | W\$ | 1118 |      |  |
| <b>Description</b>   |  |        |     |    |   |      |     |      |      |  |
| <ul style="list-style-type: none"> <li>• Profile on User Side Only</li> <li>• 90° Bridge to Connect Two Table Tops</li> <li>• Not a Freestanding Unit</li> <li>• Pre-Drilled for Required Ganging Brackets</li> </ul>              |  |        |     |    |   |      |     |      |      |  |
| <b>Specify &amp; Add: Ganging Brackets - Requires 2 Sets</b>   |  |        |     |    |   |      |     |      |      |  |
| 08-1505GB  | Ganging Bracket Kit - Set of 2 with Thumb Screws |        |     |    |   |      |     | \$   | 77   |  |

T = TFL P = HPL W = Veneer

[See Tri-One Overview For Ordering Options](#)

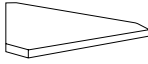
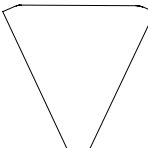

| Item  | Model No.     |  | W                | D  | H | Ship Wt | Cubic Ft | List Price |       |
|---|---------------|--|------------------|----|---|---------|----------|------------|-------|
| <b>45° BRIDGE MODULAR TOPS</b>  |               |  |                  |    |   |         |          |            |       |
| <b>Square Edge</b>  |               |  |                  |    |   |         |          |            |       |
| <i>For Use with 30"D Modular Tops:</i>  |               |  |                  |    |   |         |          |            |       |
| <br>User Side  | 86-3045MCTB   | TFL  | 27 $\frac{1}{8}$ | 30 | - | 16.1    | 2.0      | T\$ 469    |       |
|   | 86-3045MCTBH  | HPL  |                  |    |   |         |          | P\$ 636    |       |
|   | 85-3045MCTB   | Veneer   |                  |    |   |         |          | W\$ 943    |       |
| <i>For Use with 24"D Modular Tops:</i>  |               |  |                  |    |   |         |          |            |       |
| <br>User Side  | 86-2445MCTB   | TFL  | 22 $\frac{2}{8}$ | 24 | - | 10.8    | 1.4      | T\$ 419    |       |
|   | 86-2445MCTBH  | HPL  |                  |    |   |         |          | P\$ 570    |       |
|   | 85-2445MCTB   | Veneer   |                  |    |   |         |          | W\$ 839    |       |
| <b>Knife Edge</b>   |               |  |                  |    |   |         |          |            |       |
| <i>For Use with 30"D Modular Tops:</i>  |               |  |                  |    |   |         |          |            |       |
|   | 86-3045MCTBKH | HPL  | 27 $\frac{1}{8}$ | 30 | - | 16.1    | 2.0      | P\$ 834    |       |
|   | 85-3045MCTBK  | Veneer   |                  |    |   |         |          | W\$ 1148   |       |
| <i>For Use with 24"D Modular Tops:</i>  |               |  |                  |    |   |         |          |            |       |
|   | 86-2445MCTBKH | HPL  | 22 $\frac{2}{8}$ | 24 | - | 10.8    | 1.4      | P\$ 745    |       |
|   | 85-2445MCTBK  | Veneer   |                  |    |   |         |          | W\$ 1026   |       |
| <b>Description</b>  |               |  |                  |    |   |         |          |            |       |
| <ul style="list-style-type: none"> <li>• Profile on User Side Only</li> <li>• 45° Bridge to Connect Two Table Tops</li> <li>• Not a Freestanding Unit</li> <li>• Pre-Drilled for Required Ganging Brackets</li> </ul> |               |  |                  |    |   |         |          |            |       |
| <b>Specify &amp; Add: Ganging Brackets - Requires 2 Sets</b>  |               |  |                  |    |   |         |          |            |       |
|   | 08-1505GB     | Ganging Bracket Kit - Set of 2 with Thumb Screws |                  |    |   |         |          |            | \$ 77 |

Must Specify (in this order):

- Model #
- Top Finish/Color
- Ganging Brackets

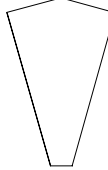
| Item  | Model No.     |  | W                | D  | H | Ship Wt | Cubic Ft | List Price |       |
|---|---------------|--|------------------|----|---|---------|----------|------------|-------|
| <b>30° BRIDGE MODULAR TOPS</b>  |               |  |                  |    |   |         |          |            |       |
| <b>Square Edge</b>  |               |  |                  |    |   |         |          |            |       |
| <i>For Use with 30"D Modular Tops:</i>  |               |  |                  |    |   |         |          |            |       |
| <br>User Side  | 86-3030MCTB   | TFL  | 19 $\frac{3}{4}$ | 30 | - | 11.4    | 1.5      | T\$ 441    |       |
|   | 86-3030MCTBH  | HPL  |                  |    |   |         |          | P\$ 596    |       |
|   | 85-3030MCTB   | Veneer   |                  |    |   |         |          | W\$ 881    |       |
| <i>For Use with 24"D Modular Tops:</i>  |               |  |                  |    |   |         |          |            |       |
| <br>User Side  | 86-2430MCTB   | TFL  | 16 $\frac{2}{3}$ | 24 | - | 8.6     | 1.1      | T\$ 401    |       |
|   | 86-2430MCTBH  | HPL  |                  |    |   |         |          | P\$ 618    |       |
|   | 85-2430MCTB   | Veneer   |                  |    |   |         |          | W\$ 797    |       |
| <b>Knife Edge</b>   |               |  |                  |    |   |         |          |            |       |
| <i>For Use with 30"D Modular Tops:</i>  |               |  |                  |    |   |         |          |            |       |
|   | 86-3030MCTBKH | HPL  | 19 $\frac{3}{4}$ | 30 | - | 11.4    | 1.5      | P\$ 782    |       |
|   | 85-3030MCTBK  | Veneer   |                  |    |   |         |          | W\$ 1074   |       |
| <i>For Use with 24"D Modular Tops:</i>  |               |  |                  |    |   |         |          |            |       |
|   | 86-2430MCTBKH | HPL  | 16 $\frac{2}{3}$ | 24 | - | 8.6     | 1.1      | P\$ 709    |       |
|   | 85-2430MCTBK  | Veneer   |                  |    |   |         |          | W\$ 973    |       |
| <b>Description</b>  |               |  |                  |    |   |         |          |            |       |
| <ul style="list-style-type: none"> <li>• Profile on User Side Only</li> <li>• 30° Bridge to Connect Two Table Tops</li> <li>• Not a Freestanding Unit</li> <li>• Pre-Drilled for Required Ganging Brackets</li> </ul> |               |  |                  |    |   |         |          |            |       |
| <b>Specify &amp; Add: Ganging Brackets - Requires 2 Sets</b>  |               |  |                  |    |   |         |          |            |       |
|   | 08-1505GB     | Ganging Bracket Kit - Set of 2 with Thumb Screws |                  |    |   |         |          |            | \$ 77 |

Must Specify (in this order):

- Model #
- Top Finish/Color
- Ganging Brackets

T = TFL P = HPL W = Veneer

[See Tri-One Overview For Ordering Options](#)

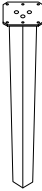
| Item  | Model No.   | Ship Wt | Cubic Ft | List Price |
|---|---|---------|----------|------------|
| ENVY POST LEG FOR MODULAR TOPS<br> | 08-0227APL2<br><i>Set of 2: For Use with 24" Pentagon Modular Tops Only</i> | 10      | 0.8      | \$ 467     |
|   | 08-0227APL4<br><i>Set of 4</i>  | 20      | 1.6      | \$ 811     |

**Description**

- Available in Aluminum
- Each Leg has Adjustable Glides
- Must Specify with Modular Top; Legs Are Not Available To Be Sold Separately

|  |   |    |     |        |
|--|---|----|-----|--------|
| VANTAGE POST LEG FOR MODULAR TOPS<br> | 08-0227SPL2<br><i>Set of 2: For Use with 24" Pentagon Modular Tops Only</i> | 10 | 0.8 | \$ 387 |
|  | 08-0227SPL4<br><i>Set of 4</i>  | 20 | 1.6 | \$ 655 |

**Description**

- Available in Aluminum
- Each Leg has Adjustable Glides
- Must Specify with Modular Top; Legs Are Not Available To Be Sold Separately

|   |  |   |     |       |
|---|--|---|-----|-------|
| GANGING BRACKET FOR MODULAR TOPS<br> | 08-1505GB<br><i>Set of 2 with Thumb Screws</i> | 2 | 0.5 | \$ 77 |
|---|--|---|-----|-------|

**FIXED MODESTY PANEL FOR RECTANGULAR MODULAR TOPS**

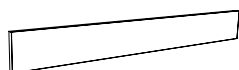

Must Specify (in this order):

Model #  
Finish/Color

| For 84"W TOPS |        |  |         |
|---------------|--------|--|---------|
| 86-0884MD     | TFL    |  | T\$ 475 |
| 86-0884MDH    | HPL    |  | P\$ 649 |
| 85-0884MD     | Veneer |  | W\$ 958 |
| For 72"W TOPS |        |  |         |
| 86-0872MD     | TFL    |  | T\$ 464 |
| 86-0872MDH    | HPL    |  | P\$ 628 |
| 85-0872MD     | Veneer |  | W\$ 930 |
| For 60"W Tops |        |  |         |
| 86-0860MD     | TFL    |  | T\$ 439 |
| 86-0860MDH    | HPL    |  | P\$ 590 |
| 85-0860MD     | Veneer |  | W\$ 876 |
| For 48"W Tops |        |  |         |
| 86-0848MD     | TFL    |  | T\$ 423 |
| 86-0848MDH    | HPL    |  | P\$ 574 |
| 85-0848MD     | Veneer |  | W\$ 847 |

**Description**

- Modesty Panels are 8"H
- Must Specify Color; See [HPL/TFL Colors](#) and [Veneer Finishes](#)

T = TFL P = HPL W = Veneer

[See Tri-One Overview For Ordering Options](#)

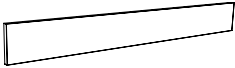
| Item   | Model No.                | Ship Wt | Cubic Ft | List Price |
|--|--------------------------|---------|----------|------------|
| <b>FIXED MODESTY PANEL FOR RECTANGULAR MODULAR TOPS WITH FLEXIBLE SIZES</b><br><br> | <b>For 84"-73"W TOPS</b> |         |          |            |
|  | 86-FLEXMD84              | TFL     |          | T\$ 475    |
|  | 86-FLEXMDH84             | HPL     |          | P\$ 649    |
|  | 85-FLEXMD84              | Veneer  |          | W\$ 958    |
|  | <b>For 72"-61"W TOPS</b> |         |          |            |
|  | 86-FLEXMD72              | TFL     |          | T\$ 464    |
|  | 86-FLEXMDH72             | HPL     |          | P\$ 628    |
|  | 85-FLEXMD72              | Veneer  |          | W\$ 930    |
|  | <b>For 60"-49"W Tops</b> |         |          |            |
|  | 86-FLEXMD60              | TFL     |          | T\$ 439    |
|  | 86-FLEXMDH60             | HPL     |          | P\$ 590    |
|  | 85-FLEXMD60              | Veneer  |          | W\$ 876    |
|  | <b>For 48"-36"W Tops</b> |         |          |            |
|  | 86-FLEXMD48              | TFL     |          | T\$ 423    |
|  | 86-FLEXMDH48             | HPL     |          | P\$ 574    |
| 85-FLEXMD48  | Veneer                   |         | W\$ 847  |            |

Must Specify (in this order):

Model #  
Finish/Color

**Description**

- Modesty Panels are 8"H
- Must Specify Color; See [HPL/TFL Colors](#) and [Veneer Finishes](#)

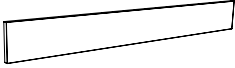
|   |                                |        |         |          |
|---|--------------------------------|--------|---------|----------|
| <b>FIXED MODESTY PANEL FOR LEFT &amp; RIGHT TRAPEZOID MODULAR TOPS</b><br><br> | <b>For 30"D TRAPEZOID TOPS</b> |        |         |          |
|   | <b>For 84"W TOPS</b>           |        |         |          |
|   | 86-0884MDT30                   | TFL    |         | T\$ 505  |
|   | 86-0884MDTH30                  | HPL    |         | P\$ 681  |
|   | 85-0884MDT30                   | Veneer |         | W\$ 1009 |
|   | <b>For 72"W TOPS</b>           |        |         |          |
|   | 86-0872MDT30                   | TFL    |         | T\$ 455  |
|   | 86-0872MDTH30                  | HPL    |         | P\$ 617  |
|   | 85-0872MDT30                   | Veneer |         | W\$ 914  |
|   | <b>For 60"W Tops</b>           |        |         |          |
|   | 86-0860MDT30                   | TFL    |         | T\$ 427  |
|   | 86-0860MDTH30                  | HPL    |         | P\$ 581  |
|   | 85-0860MDT30                   | Veneer |         | W\$ 860  |
|   | <b>For 48"W Tops</b>           |        |         |          |
|   | 86-0848MDT30                   | TFL    |         | T\$ 404  |
|   | 86-0848MDTH30                  | HPL    |         | P\$ 545  |
|   | 85-0848MDT30                   | Veneer |         | W\$ 808  |
|   | <b>For 24"D TRAPEZOID TOPS</b> |        |         |          |
|   | <b>For 84"W TOPS</b>           |        |         |          |
|   | 86-0884MDT24                   | TFL    |         | T\$ 494  |
|   | 86-0884MDTH24                  | HPL    |         | P\$ 670  |
|   | 85-0884MDT24                   | Veneer |         | W\$ 990  |
|   | <b>For 72"W TOPS</b>           |        |         |          |
|   | 86-0872MDT24                   | TFL    |         | T\$ 445  |
|   | 86-0872MDTH24                  | HPL    |         | P\$ 602  |
|   | 85-0872MDT24                   | Veneer |         | W\$ 890  |
|   | <b>For 60"W Tops</b>           |        |         |          |
| 86-0860MDT24  | TFL                            |        | T\$ 419 |          |
| 86-0860MDTH24   | HPL                            |        | P\$ 570 |          |
| 85-0860MDT24  | Veneer                         |        | W\$ 839 |          |
| <b>For 48"W Tops</b>  |                                |        |         |          |
| 86-0848MDT24  | TFL                            |        | T\$ 390 |          |
| 86-0848MDTH24   | HPL                            |        | P\$ 534 |          |
| 85-0848MDT24  | Veneer                         |        | W\$ 790 |          |

**Description**

- Modesty Panels are 8"H
- Must Specify Color; See [HPL/TFL Colors](#) and [Veneer Finishes](#)

T = TFL P = HPL W = Veneer

[See Tri-One Overview For Ordering Options](#)

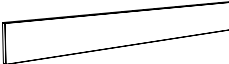
| Item  | Model No.                      | Ship Wt | Cubic Ft | List Price |      |
|---|--------------------------------|---------|----------|------------|------|
| <b>FIXED MODESTY PANEL FOR LEFT &amp; RIGHT TRAPEZOID MODULAR TOPS WITH FLEXIBLE SIZES</b><br><br> | <b>For 30"D TRAPEZOID TOPS</b> |         |          |            |      |
|   | <b>For 84"W-73"W TOPS</b>      |         |          |            |      |
|   | 86-FLEXMDTRP3084               | TFL     |          | T\$        | 505  |
|   | 86-FLEXMDTRP30H84              | HPL     |          | P\$        | 681  |
|   | 85-FLEXMDTRP3084               | Veneer  |          | W\$        | 1009 |
|   | <b>For 72"W-61"W TOPS</b>      |         |          |            |      |
|   | 86-FLEXMDTRP3072               | TFL     |          | T\$        | 455  |
|   | 86-FLEXMDTRP30H72              | HPL     |          | P\$        | 617  |
|   | 85-FLEXMDTRP3072               | Veneer  |          | W\$        | 914  |
|   | <b>For 60"W-49"W Tops</b>      |         |          |            |      |
|   | 86-FLEXMDTRP3060               | TFL     |          | T\$        | 427  |
|   | 86-FLEXMDTRP30H60              | HPL     |          | P\$        | 581  |
|   | 85-FLEXMDTRP3060               | Veneer  |          | W\$        | 860  |
|   | <b>For 48"W-36"W Tops</b>      |         |          |            |      |
|   | 86-FLEXMDTRP3048               | TFL     |          | T\$        | 404  |
|   | 86-FLEXMDTRP30H48              | HPL     |          | P\$        | 545  |
|   | 85-FLEXMDTRP3048               | Veneer  |          | W\$        | 808  |
|   | <b>For 24"D TRAPEZOID TOPS</b> |         |          |            |      |
|   | <b>For 84"W-73"W TOPS</b>      |         |          |            |      |
|   | 86-FLEXMDTRP2484               | TFL     |          | T\$        | 494  |
|   | 86-FLEXMDTRP24H84              | HPL     |          | P\$        | 670  |
|   | 85-FLEXMDTRP2484               | Veneer  |          | W\$        | 990  |
|   | <b>For 72"W-61"W TOPS</b>      |         |          |            |      |
|   | 86-FLEXMDTRP2472               | TFL     |          | T\$        | 445  |
|   | 86-FLEXMDTRP24H72              | HPL     |          | P\$        | 602  |
|   | 85-FLEXMDTRP2472               | Veneer  |          | W\$        | 890  |
|   | <b>For 60"W-49"W Tops</b>      |         |          |            |      |
| 86-FLEXMDTRP2460  | TFL                            |         | T\$      | 419        |      |
| 86-FLEXMDTRP24H60   | HPL                            |         | P\$      | 570        |      |
| 85-FLEXMDTRP2460  | Veneer                         |         | W\$      | 839        |      |
| <b>For 48"W-36"W Tops</b>   |                                |         |          |            |      |
| 86-FLEXMDTRP2448  | TFL                            |         | T\$      | 390        |      |
| 86-FLEXMDTRP24H48   | HPL                            |         | P\$      | 534        |      |
| 85-FLEXMDTRP2448  | Veneer                         |         | W\$      | 790        |      |

Must Specify (in this order):

Model #  
Finish/Color

**Description**

- Modesty Panels are 8"H
- Must Specify Color; See [HPL/TFL Colors](#) and [Veneer Finishes](#)

T = TFL P = HPL W = Veneer

[See Tri-One Overview For Ordering Options](#)

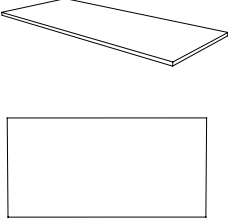
| Item  | Model No.  |        | Kneespace | W  | D  | H     | Ship Wt | Cubic Ft | List Price |
|---|------------|--------|-----------|----|----|-------|---------|----------|------------|
| <b>RECTANGULAR MEETING TOPS</b>   |            |        |           |    |    |       |         |          |            |
| <b>Square Edge</b>  |            |        |           |    |    |       |         |          |            |
|  | 86-4296MT  | TFL    | 55        | 96 | 42 | -     | 122.2   | 9.4      | T\$ 1094   |
|   | 86-4296MTH | HPL    |           |    |    |       |         |          | P\$ 1483   |
|   | 85-4296MT  | Veneer |           |    |    |       |         |          | W\$ 2196   |
|   | 86-4284MT  | TFL    | 47        | 84 | 42 | -     | 106.9   | 8.2      | T\$ 1028   |
|   | 86-4284MTH | HPL    |           |    |    |       |         |          | P\$ 1393   |
|   | 85-4284MT  | Veneer |           |    |    |       |         |          | W\$ 2060   |
|   | 86-4272MT  | TFL    | 39        | 72 | 42 | -     | 91.7    | 7.1      | T\$ 914    |
|   | 86-4272MTH | HPL    |           |    |    |       |         |          | P\$ 1237   |
|   | 85-4272MT  | Veneer |           |    |    |       |         |          | W\$ 1831   |
|   | 86-4260MT  | TFL    | 31½       | 60 | 42 | -     | 76.4    | 5.7      | T\$ 837    |
|   | 86-4260MTH | HPL    |           |    |    |       |         |          | P\$ 1135   |
|   | 85-4260MT  | Veneer |           |    |    |       |         |          | W\$ 1681   |
|   | 86-3696MT  | TFL    | 55        | 96 | 36 | -     | 104.8   | 8.1      | T\$ 988    |
|   | 86-3696MTH | HPL    |           |    |    |       |         |          | P\$ 1337   |
|   | 85-3696MT  | Veneer |           |    |    |       |         |          | W\$ 1983   |
|   | 86-3684MT  | TFL    | 47        | 84 | 36 | -     | 92      | 7.1      | T\$ 919    |
|   | 86-3684MTH | HPL    |           |    |    |       |         |          | P\$ 1246   |
|   | 85-3684MT  | Veneer |           |    |    |       |         |          | W\$ 1844   |
| 86-3672MT   | TFL        | 39     | 72        | 36 | -  | 78.6  | 6.1     | T\$ 836  |            |
| 86-3672MTH  | HPL        |        |           |    |    |       |         | P\$ 1132 |            |
| 85-3672MT   | Veneer     |        |           |    |    |       |         | W\$ 1678 |            |
| 86-3660MT   | TFL        | 31½    | 60        | 36 | -  | 65.5  | 5.1     | T\$ 767  |            |
| 86-3660MTH  | HPL        |        |           |    |    |       |         | P\$ 1041 |            |
| 85-3660MT   | Veneer     |        |           |    |    |       |         | W\$ 1543 |            |
| <b>Knife Edge</b>   |            |        |           |    |    |       |         |          |            |
| 86-4296MTKH   | HPL        | 55     | 96        | 42 | -  | 122.2 | 9.4     | P\$ 1943 |            |
| 85-4296MTK  | Veneer     |        |           |    |    |       |         | W\$ 2678 |            |
| 86-4284MTKH   | HPL        | 47     | 84        | 42 | -  | 106.9 | 8.2     | P\$ 1823 |            |
| 85-4284MTK  | Veneer     |        |           |    |    |       |         | W\$ 2513 |            |
| 86-4272MTKH   | HPL        | 39     | 72        | 42 | -  | 91.7  | 7.1     | P\$ 1622 |            |
| 85-4272MTK  | Veneer     |        |           |    |    |       |         | W\$ 2235 |            |
| 86-4260MTKH   | HPL        | 31½    | 60        | 42 | -  | 76.4  | 5.7     | P\$ 1488 |            |
| 85-4260MTK  | Veneer     |        |           |    |    |       |         | W\$ 2047 |            |
| 86-3696MTKH   | HPL        | 55     | 96        | 36 | -  | 104.8 | 8.1     | P\$ 1753 |            |
| 85-3696MTK  | Veneer     |        |           |    |    |       |         | W\$ 2417 |            |
| 86-3684MTKH   | HPL        | 47     | 84        | 36 | -  | 92    | 7.1     | P\$ 1628 |            |
| 85-3684MTK  | Veneer     |        |           |    |    |       |         | W\$ 2250 |            |
| 86-3672MTKH   | HPL        | 39     | 72        | 36 | -  | 78.6  | 6.1     | P\$ 1486 |            |
| 85-3672MTK  | Veneer     |        |           |    |    |       |         | W\$ 2046 |            |
| 86-3660MTKH   | HPL        | 31½    | 60        | 36 | -  | 65.5  | 5.1     | P\$ 1365 |            |
| 85-3660MTK  | Veneer     |        |           |    |    |       |         | W\$ 1880 |            |

Must Specify (in this order):  
 Model #  
 Top Finish/Color  
 Leg Model # and Color (if applicable)  
 Grommet/Power/Data Location





Must Order X-Base, Y-Base, or Strut Legs. [See Base/Leg Options.](#)

**Description**

- Profiled on All Four Sides
- Seated Height Base/Legs Required (Assembly Required); Sold Separately, [See Base/Legs Options](#)
- When Using with Strut Legs, We Recommend Using Two Stiffener Bars on 42" D Tops that are 72" and wider; Must Order Separately, [See Strut Details](#)
- Strut Leg Not Available on 60"W x 36"D Tops or 60"W x 42"D
- Power & Data Options Available; Sold Separately, [See Multiple Units](#) and [See Locations](#)

T = TFL P = HPL W = Veneer

[See Tri-One Overview For Ordering Options](#)

| Item  | Model No.          |        | Kneespace | W  | D  | H     | Ship Wt | Cubic Ft | List Price |  |
|---|--------------------|--------|-----------|----|----|-------|---------|----------|------------|--|
| <b>SOFT RECTANGULAR MEETING TOPS</b><br><br><br><br><br><br><p>Must Specify (in this order):<br/>                     Model #<br/>                     Top Finish/Color<br/>                     Leg Model # and Color (if applicable)<br/>                     Grommet/Power/Data Location</p> | <b>Square Edge</b> |        |           |    |    |       |         |          |            |  |
|   | 86-4296SMT         | TFL    | 55        | 96 | 42 | -     | 122.2   | 9.4      | T\$ 1057   |  |
|   | 86-4296SMTH        | HPL    |           |    |    |       |         |          | P\$ 1432   |  |
|   | 85-4296SMT         | Veneer |           |    |    |       |         |          | W\$ 2120   |  |
|   | 86-4284SMT         | TFL    | 47        | 84 | 42 | -     | 106.9   | 8.2      | T\$ 995    |  |
|   | 86-4284SMTH        | HPL    |           |    |    |       |         |          | P\$ 1347   |  |
|   | 85-4284SMT         | Veneer |           |    |    |       |         |          | W\$ 1994   |  |
|   | 86-4272SMT         | TFL    | 39        | 72 | 42 | -     | 91.7    | 7.1      | T\$ 882    |  |
|   | 86-4272SMTH        | HPL    |           |    |    |       |         |          | P\$ 1198   |  |
|   | 85-4272SMT         | Veneer |           |    |    |       |         |          | W\$ 1772   |  |
|   | 86-4260SMT         | TFL    | 31½       | 60 | 42 | -     | 76.4    | 5.7      | T\$ 812    |  |
|   | 86-4260SMTH        | HPL    |           |    |    |       |         |          | P\$ 1100   |  |
|   | 85-4260SMT         | Veneer |           |    |    |       |         |          | W\$ 1627   |  |
|   | 86-3696SMT         | TFL    | 55        | 96 | 36 | -     | 104.8   | 8.1      | T\$ 952    |  |
|   | 86-3696SMTH        | HPL    |           |    |    |       |         |          | P\$ 1293   |  |
|   | 85-3696SMT         | Veneer |           |    |    |       |         |          | W\$ 1909   |  |
|   | 86-3684SMT         | TFL    | 47        | 84 | 36 | -     | 92      | 7.1      | T\$ 888    |  |
|   | 86-3684SMTH        | HPL    |           |    |    |       |         |          | P\$ 1202   |  |
|   | 85-3684SMT         | Veneer |           |    |    |       |         |          | W\$ 1781   |  |
|   | 86-3672SMT         | TFL    | 39        | 72 | 36 | -     | 78.6    | 6.1      | T\$ 810    |  |
|   | 86-3672SMTH        | HPL    |           |    |    |       |         |          | P\$ 1096   |  |
|   | 85-3672SMT         | Veneer |           |    |    |       |         |          | W\$ 1623   |  |
|   | 86-3660SMT         | TFL    | 31½       | 60 | 36 | -     | 65.5    | 5.1      | T\$ 746    |  |
|   | 86-3660SMTH        | HPL    |           |    |    |       |         |          | P\$ 1009   |  |
|   | 85-3660SMT         | Veneer |           |    |    |       |         |          | W\$ 1496   |  |
|   | <b>Knife Edge</b>  |        |           |    |    |       |         |          |            |  |
|   | 86-4296SMTKH       | HPL    | 55        | 96 | 42 | -     | 122.2   | 9.4      | P\$ 1877   |  |
| 85-4296SMTK   | Veneer             |        |           |    |    |       |         | W\$ 2585 |            |  |
| 86-4284SMTKH  | HPL                | 47     | 84        | 42 | -  | 106.9 | 8.2     | P\$ 1766 |            |  |
| 85-4284SMTK   | Veneer             |        |           |    |    |       |         | W\$ 2433 |            |  |
| 86-4272SMTKH  | HPL                | 39     | 72        | 42 | -  | 91.7  | 7.1     | P\$ 1571 |            |  |
| 85-4272SMTK   | Veneer             |        |           |    |    |       |         | W\$ 2160 |            |  |
| 86-4260SMTKH  | HPL                | 31½    | 60        | 42 | -  | 76.4  | 5.7     | P\$ 1442 |            |  |
| 85-4260SMTK   | Veneer             |        |           |    |    |       |         | W\$ 1988 |            |  |
| 86-3696SMTKH  | HPL                | 55     | 96        | 36 | -  | 104.8 | 8.1     | P\$ 1691 |            |  |
| 85-3696SMTK   | Veneer             |        |           |    |    |       |         | W\$ 2326 |            |  |
| 86-3684SMTKH  | HPL                | 47     | 84        | 36 | -  | 92    | 7.1     | P\$ 1576 |            |  |
| 85-3684SMTK   | Veneer             |        |           |    |    |       |         | W\$ 2171 |            |  |
| 86-3672SMTKH  | HPL                | 39     | 72        | 36 | -  | 78.6  | 6.1     | P\$ 1435 |            |  |
| 85-3672SMTK   | Veneer             |        |           |    |    |       |         | W\$ 1981 |            |  |
| 86-3660SMTKH  | HPL                | 31½    | 60        | 36 | -  | 65.5  | 5.1     | P\$ 1324 |            |  |
| 85-3660SMTK   | Veneer             |        |           |    |    |       |         | W\$ 1823 |            |  |

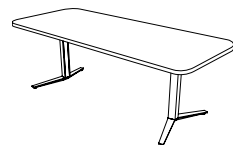

Must Order X-Base, Y-Base, or Strut Legs. [See Base/Leg Options.](#)

**Description**

- Profiled on All Four Sides
- Seated Height Base/Legs Required (Assembly Required); Sold Separately, [See Base/Legs Options](#)
- When Using with Strut Legs, We Recommend Using Two Stiffener Bars on 42" D Tops that are 72" and wider; Must Order Separately, [See Strut Details](#)
- Strut Leg Not Available on 60"W x 36"D Tops or 60"W x 42"D
- Power & Data Options Available; Sold Separately, [See Multiple Units](#) and [See Locations](#)

T = TFL P = HPL W = Veneer

[See Tri-One Overview For Ordering Options](#)

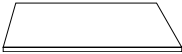
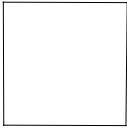
| Item  | Model No.  |                    | W  | D  | H | Ship Wt | Cubic Ft | List Price |  |
|---|------------|--------------------|----|----|---|---------|----------|------------|--|
| <b>SQUARE MEETING TOPS</b>  |            | <b>Square Edge</b> |    |    |   |         |          |            |  |
|  | 86-4242SQ  | TFL                | 42 | 42 | - | 70      | 3.3      | T\$ 644    |  |
|   | 86-4242SQH | HPL                |    |    |   |         |          | P\$ 871    |  |
|   | 85-4242SQ  | Veneer             |    |    |   |         |          | W\$ 1288   |  |
|  | 86-3636SQ  | TFL                | 36 | 36 | - | 37      | 2.5      | T\$ 547    |  |
|   | 86-3636SQH | HPL                |    |    |   |         |          | P\$ 745    |  |
|   | 85-3636SQ  | Veneer             |    |    |   |         |          | W\$ 1100   |  |
|   | 86-3030SQ  | TFL                | 30 | 30 | - | 30      | 2.2      | T\$ 483    |  |
|   | 86-3030SQH | HPL                |    |    |   |         |          | P\$ 654    |  |
|   | 85-3030SQ  | Veneer             |    |    |   |         |          | W\$ 965    |  |

Must Specify (in this order):

- Model #
- Top Finish/Color
- Leg Model # and Color (if applicable)

| <b>Knife Edge</b> |        |    | W  | D | H  | Ship Wt | Cubic Ft | List Price |
|-------------------|--------|----|----|---|----|---------|----------|------------|
| 86-4242SQKH       | HPL    | 42 | 42 | - | 70 | 3.3     | P\$ 1138 |            |
| 85-4242SQK        | Veneer |    |    |   |    |         | W\$ 1573 |            |
| 86-3636SQKH       | HPL    | 36 | 36 | - | 37 | 2.5     | P\$ 973  |            |
| 85-3636SQK        | Veneer |    |    |   |    |         | W\$ 1341 |            |
| 86-3030SQKH       | HPL    | 30 | 30 | - | 30 | 2.2     | P\$ 857  |            |
| 85-3030SQK        | Veneer |    |    |   |    |         | W\$ 1178 |            |

**Description**

- Profiled on All Four Sides
- Base/Legs Required (Assembly Required); Sold Separately, [See Base/Legs Options](#)
- Strut Legs Available on 42" Tops Only

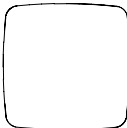

Must Order X-Base or Strut Legs. [See Base/Leg Options.](#)

|   |             |                    |    |    |   |    |     |          |  |
|---|-------------|--------------------|----|----|---|----|-----|----------|--|
| <b>SOFT SQUARE MEETING TOPS</b>   |             | <b>Square Edge</b> |    |    |   |    |     |          |  |
|  | 86-4242SSQ  | TFL                | 42 | 42 | - | 70 | 3.3 | T\$ 621  |  |
|   | 86-4242SSQH | HPL                |    |    |   |    |     | P\$ 840  |  |
|   | 85-4242SSQ  | Veneer             |    |    |   |    |     | W\$ 1288 |  |
|  | 86-3636SSQ  | TFL                | 36 | 36 | - | 37 | 2.5 | T\$ 534  |  |
|   | 86-3636SSQH | HPL                |    |    |   |    |     | P\$ 720  |  |
|   | 85-3636SSQ  | Veneer             |    |    |   |    |     | W\$ 1068 |  |
|   | 86-3030SSQ  | TFL                | 30 | 30 | - | 30 | 2.2 | T\$ 470  |  |
|   | 86-3030SSQH | HPL                |    |    |   |    |     | P\$ 638  |  |
|   | 85-3030SSQ  | Veneer             |    |    |   |    |     | W\$ 947  |  |

Must Specify (in this order):

- Model #
- Top Finish/Color
- Leg Model # and Color (if applicable)

| <b>Knife Edge</b> |        |    | W  | D | H  | Ship Wt | Cubic Ft | List Price |
|-------------------|--------|----|----|---|----|---------|----------|------------|
| 86-4242SSQKH      | HPL    | 42 | 42 | - | 70 | 3.3     | P\$ 1101 |            |
| 85-4242SSQK       | Veneer |    |    |   |    |         | W\$ 1519 |            |
| 86-3636SSQKH      | HPL    | 36 | 36 | - | 37 | 2.5     | P\$ 946  |            |
| 85-3636SSQK       | Veneer |    |    |   |    |         | W\$ 1303 |            |
| 86-3030SSQKH      | HPL    | 30 | 30 | - | 30 | 2.2     | P\$ 837  |            |
| 85-3030SSQK       | Veneer |    |    |   |    |         | W\$ 1155 |            |

**Description**



- Profiled on All Four Sides
- Base/Legs Required (Assembly Required); Sold Separately, [See Base/Legs Options](#)
- Strut Legs Available on 42" Tops Only



Must Order X-Base or Strut Legs. [See Base/Leg Options.](#)

T = TFL P = HPL W = Veneer

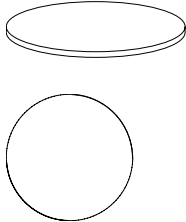
[See Tri-One Overview For Ordering Options](#)



| Item  | Model No.   |                    | W                 | D  | H  | Ship Wt | Cubic Ft | List Price |          |  |
|---|---|--------------------|-------------------|----|----|---------|----------|------------|----------|--|
| <b>ROUND MEETING TOPS</b>   |   | <b>Square Edge</b> |                   |    |    |         |          |            |          |  |
|  | 86-4848CT   | TFL                | 48                | 48 | -  | 95      | 4.3      | T\$ 695    |          |  |
|   | 86-4848CTH  | HPL                |                   |    |    |         |          | P\$ 943    |          |  |
|   | 85-4848CT   | Veneer             |                   |    |    |         |          | W\$ 1394   |          |  |
|   | 86-4242CT   | TFL                | 42                | 42 | -  | 70      | 3.3      | T\$ 603    |          |  |
|   | 86-4242CTH  | HPL                |                   |    |    |         |          | P\$ 818    |          |  |
|   | 85-4242CT   | Veneer             |                   |    |    |         |          | W\$ 1210   |          |  |
|   | 86-3636CT   | TFL                | 36                | 36 | -  | 37      | 2.5      | T\$ 528    |          |  |
|   | 86-3636CTH  | HPL                |                   |    |    |         |          | P\$ 715    |          |  |
|   | 85-3636CT   | Veneer             |                   |    |    |         |          | W\$ 1058   |          |  |
|   | 86-3030CT   | TFL                | 30                | 30 | -  | 30      | 2.2      | T\$ 467    |          |  |
|   | 86-3030CTH  | HPL                |                   |    |    |         |          | P\$ 631    |          |  |
|   | 85-3030CT   | Veneer             |                   |    |    |         |          | W\$ 935    |          |  |
|   |   |                    | <b>Knife Edge</b> |    |    |         |          |            |          |  |
|   |  | 86-4848CTKH        | HPL               | 48 | 48 | -       | 95       | 4.3        | P\$ 1234 |  |
|   |   | 85-4848CTK         | Veneer            |    |    |         |          |            | W\$ 1700 |  |
| 86-4242CTKH   |   | HPL                | 42                | 42 | -  | 70      | 3.3      | P\$ 1071   |          |  |
| 85-4242CTK  |   | Veneer             |                   |    |    |         |          | W\$ 1476   |          |  |
| 86-3636CTKH   |   | HPL                | 36                | 36 | -  | 37      | 2.5      | P\$ 937    |          |  |
| 85-3636CTK  |   | Veneer             |                   |    |    |         |          | W\$ 1292   |          |  |
| 86-3030CTKH   |   | HPL                | 30                | 30 | -  | 30      | 2.2      | P\$ 828    |          |  |
| 85-3030CTK  |   | Veneer             |                   |    |    |         |          | W\$ 1140   |          |  |

Must Specify (in this order):  
 Model #  
 Top Finish/Color  
 Leg Model # and Color (if applicable)

Must Order X-Base or Strut Legs. [See Base/Leg Options.](#)

**Description**

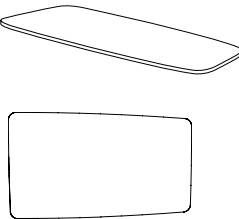
- Profiled on All Sides
- Base/Legs Required (Assembly Required); Sold Separately, [See Base/Leg Options](#)
- Strut Legs Available on 48" Tops Only

| Item  | Model No.   |                    | W                 | D     | H     | Ship Wt | Cubic Ft | List Price |          |  |
|---|---|--------------------|-------------------|-------|-------|---------|----------|------------|----------|--|
| <b>SOFT VIEW MEETING TOPS</b>   |   | <b>Square Edge</b> |                   |       |       |         |          |            |          |  |
|  | 86-4296SVT  | TFL                | 96                | 42-36 | -     | 122.2   | 9.4      | T\$ 1052   |          |  |
|   | 86-4296SVTH   | HPL                |                   |       |       |         |          | P\$ 1423   |          |  |
|   | 85-4296SVT  | Veneer             |                   |       |       |         |          | W\$ 2108   |          |  |
|   | 86-4284SVT  | TFL                | 84                | 42-36 | -     | 106.9   | 8.2      | T\$ 951    |          |  |
|   | 86-4284SVTH   | HPL                |                   |       |       |         |          | P\$ 1288   |          |  |
|   | 85-4284SVT  | Veneer             |                   |       |       |         |          | W\$ 1908   |          |  |
|   | 86-4272SVT  | TFL                | 72                | 42-36 | -     | 91.7    | 7.1      | T\$ 881    |          |  |
|   | 86-4272SVTH   | HPL                |                   |       |       |         |          | P\$ 1197   |          |  |
|   | 85-4272SVT  | Veneer             |                   |       |       |         |          | W\$ 1770   |          |  |
|   |   |                    | <b>Knife Edge</b> |       |       |         |          |            |          |  |
|   |  | 86-4296SVTKH       | HPL               | 96    | 42-36 | -       | 122.2    | 9.4        | P\$ 1866 |  |
|   |   | 85-4296SVTK        | Veneer            |       |       |         |          |            | W\$ 2573 |  |
|   |   | 86-4284SVTKH       | HPL               | 84    | 42-36 | -       | 106.9    | 8.2        | P\$ 1686 |  |
|   |   | 85-4284SVTK        | Veneer            |       |       |         |          |            | W\$ 2325 |  |
|   |   | 86-4272SVTKH       | HPL               | 72    | 42-36 | -       | 91.7     | 7.1        | P\$ 1568 |  |
| 85-4272SVTK   |   | Veneer             |                   |       |       |         |          | W\$ 2159   |          |  |

Must Specify (in this order):  
 Model #  
 Top Finish/Color  
 Leg Model # and Color (if applicable)  
 Grommet/Power/Data Location

Must Order X-Base, Y-Base, or Strut Legs. [See Base/Leg Options.](#)

**Description**

- Profiled on All Four Sides
- Base/Legs Required (Assembly Required); Sold Separately, [See Base/Leg Options](#)
- When Using with Strut Legs, We Recommend Using Two Stiffener Bars on Tops that are 84" and wider; Must Order Separately, [See Strut Details](#)
- Power & Data Options Available; Sold Separately, [See Multiple Units](#) and [See Locations](#)

T = TFL P = HPL W = Veneer

[See Tri-One Overview For Ordering Options](#)

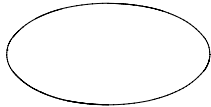

| Item  | Model No.    |        | W  | D  | H | Ship Wt | Cubic Ft | List Price |
|---|--------------|--------|----|----|---|---------|----------|------------|
| <b>ELLIPSE MEETING TOPS</b>   |              |        |    |    |   |         |          |            |
| <b>Square Edge</b>  |              |        |    |    |   |         |          |            |
|  | 86-4284EMT   | TFL    | 84 | 42 | - | 106.9   | 8.2      | T\$ 987    |
|   | 86-4284EMTH  | HPL    |    |    |   |         |          | P\$ 1335   |
|   | 85-4284EMT   | Veneer |    |    |   |         |          | W\$ 1978   |
|  | 86-3672EMT   | TFL    | 72 | 36 | - | 78.6    | 6.1      | T\$ 800    |
|   | 86-3672EMTH  | HPL    |    |    |   |         |          | P\$ 1086   |
|   | 85-3672EMT   | Veneer |    |    |   |         |          | W\$ 1608   |
| <b>Knife Edge</b>   |              |        |    |    |   |         |          |            |
|   | 86-4284EMTKH | HPL    | 84 | 42 | - | 106.9   | 8.2      | P\$ 1749   |
|   | 85-4284EMTK  | Veneer |    |    |   |         |          | W\$ 2409   |
|   | 86-3672EMTKH | HPL    | 72 | 36 | - | 78.6    | 6.1      | P\$ 1421   |
|   | 85-3672EMTK  | Veneer |    |    |   |         |          | W\$ 1959   |

Must Specify (in this order):  
 Model #  
 Top Finish/Color  
 Leg Model #  
 Grommet/Power/Data Location

**Description**

- Includes Stiffener Bar
- Profiled on All Four Sides
- Legs Required (Assembly Required); Sold Separately, See Below
- Power & Data Options Available; Sold Separately, [See Multiple Units](#) and [See Locations](#)

**Specify & Add: Your Choice Of Legs**



|             |   |  |    |     |  |        |
|-------------|---|--|----|-----|--|--------|
| 08-0227APL4 | Envy Post Leg (Set of 4)  |  | 20 | 1.6 |  | \$ 811 |
|             | <ul style="list-style-type: none"> <li>• Available in Aluminum</li> <li>• Each Leg has Adjustable Glides</li> <li>• Legs Are Not Available To Be Sold Separately</li> </ul> |  |    |     |  |        |
| 08-0227SPL4 | Vantage Post Leg (Set of 4)   |  | 20 | 1.6 |  | \$ 655 |
|             | <ul style="list-style-type: none"> <li>• Available in Aluminum</li> <li>• Each Leg has Adjustable Glides</li> <li>• Legs Are Not Available To Be Sold Separately</li> </ul> |  |    |     |  |        |



**Must Order Envy or Vantage Post Legs.**

T = TFL P = HPL W = Veneer

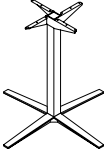
[See Tri-One Overview For Ordering Options](#)

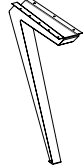
| Item  | Model No.   | Ship Wt | Cubic Ft | List Price |
|---|---|---------|----------|------------|
|    | <b>Large X-Base: For Use with 42"D and 48"D Tops</b>                |         |          |            |
|   | 08-2642LXB  | 33      | 20.0     | \$ 1240    |
|   | <i>For 42"H Tables; Square, Soft Square, and Circular Tops Only</i> |         |          |            |
|   | 08-2636LXB  | 30      | 17.2     | \$ 1196    |
|   | <i>For 36"H Tables; Square, Soft Square, and Circular Tops Only</i> |         |          |            |
|   | 08-2630LXB  | 27      | 14.5     | \$ 1144    |
|   | <i>For 30"H Tables</i>  |         |          |            |
|   | <b>Small X-Base: For Use with 30"D and 36"D Tops</b>                |         |          |            |
|   | 08-2042SXB  | 27      | 15.9     | \$ 1158    |
|   | <i>For 42"H Tables; Square, Soft Square, and Circular Tops Only</i> |         |          |            |
| 08-2036SXB  | 24  | 13.7    | \$ 1112  |            |
| <i>For 36"H Tables; Square, Soft Square, and Circular Tops Only</i>   |   |         |          |            |
| 08-2030SXB  | 21  | 11.6    | \$ 1068  |            |
| <i>For 30"H Tables</i>  |   |         |          |            |
| <b>Description</b>  |   |         |          |            |
| <ul style="list-style-type: none"> <li>• Available in Aluminum</li> <li>• Square, Soft Square, and Circular Tops Require One (1) Base; All Other Meeting Tops Require Two (2) Seated Height (30"H) Bases</li> <li>• Bases Are Not Available To Be Sold Separately</li> </ul>  |   |         |          |            |
|    | 08-2828YLG96  | 47      | 6.5      | \$ 1628    |
|   | <i>For Use with 96"W Meeting Tops</i>                               |         |          |            |
|   | 08-2828YLG84  | 43      | 5.4      | \$ 1607    |
|   | <i>For Use with 84"W Meeting Tops</i>                               |         |          |            |
|   | 08-2828YLG72  | 39      | 4.3      | \$ 1572    |
| <i>For Use with 72"W Meeting Tops</i>   |   |         |          |            |
| 08-2828YLG60  | 35  | 3.2     | \$ 1508  |            |
| <i>For Use with 60"W Meeting Tops</i>   |   |         |          |            |
| <b>Description</b>  |   |         |          |            |
| <ul style="list-style-type: none"> <li>• Available in Aluminum</li> <li>• Y-Base Includes Trough with Removable Panels for Wire Management</li> <li>• Bases Are Not Available To Be Sold Separately</li> </ul>  |   |         |          |            |
|    | 01-2228STR4   | 64      | 9.0      | \$ 2398    |
|   | <i>Set of 4</i>   |         |          |            |
| <b>Description</b>  |   |         |          |            |
| <ul style="list-style-type: none"> <li>• Available in Aluminum (ALUM) or Black (BLK), Must Specify Color</li> <li>• Built-In Wire Management Cover on Inside of Legs</li> <li>• Each Leg has Adjustable Glides</li> <li>• See Individual Meeting Tops For Usage Availability and Stiffener Bar Recommendations (Order Separately, Shown Below)</li> <li>• Legs Not Available To Be Sold Separately; For Use with Indiana Furniture Tops Only</li> </ul> |   |         |          |            |
| <b>Specify &amp; Add: Stiffener Bar</b>   |   |         |          |            |
| 01-00048SB  | Stiffener Bar   |         |          | \$ 234     |

T = TFL P = HPL W = Veneer

[See Tri-One Overview For Ordering Options](#)

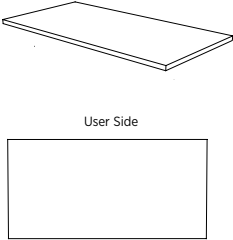
| Item   | Model No.   | Kneespace | W  | D  | H | Ship Wt | Cubic Ft | List Price |
|--|-------------|-----------|----|----|---|---------|----------|------------|
| <b>RECTANGULAR TRAINING TOPS</b>   |             |           |    |    |   |         |          |            |
| <b>Square Edge</b>   |             |           |    |    |   |         |          |            |
|  <p>User Side</p> | 86-3072TT   | 65½       | 72 | 30 | - | 75.5    | 5.2      | T\$ 691    |
|  | 86-3072TTH  |           |    |    |   |         |          | P\$ 935    |
|  | 86-3060TT   | 53¾       | 60 | 30 | - | 64.6    | 4.3      | T\$ 616    |
|  | 86-3060TTH  |           |    |    |   |         |          | P\$ 834    |
|  | 86-3048TT   | 41½       | 48 | 30 | - | 53.7    | 3.5      | T\$ 561    |
|  | 86-3048TTH  |           |    |    |   |         |          | P\$ 760    |
|  | 86-2472TT   | 65½       | 72 | 24 | - | 62.4    | 4.2      | T\$ 629    |
|  | 86-2472TTH  |           |    |    |   |         |          | P\$ 857    |
|  | 86-2460TT   | 53¾       | 60 | 24 | - | 53.7    | 3.5      | T\$ 568    |
|  | 86-2460TTH  |           |    |    |   |         |          | P\$ 764    |
|  | 86-2448TT   | 41½       | 48 | 24 | - | 44.9    | 2.8      | T\$ 519    |
|  | 86-2448TTH  |           |    |    |   |         |          | P\$ 703    |
|  | 86-1872TT   | 65½       | 72 | 18 | - | 49.3    | 3.2      | T\$ 570    |
|  | 86-1872TTH  |           |    |    |   |         |          | P\$ 768    |
|  | 86-1860TT   | 53¾       | 60 | 18 | - | 43.7    | 2.7      | T\$ 513    |
|  | 86-1860TTH  |           |    |    |   |         |          | P\$ 695    |
|  | 86-1848TT   | 41½       | 48 | 18 | - | 36.2    | 2.2      | T\$ 474    |
|  | 86-1848TTH  |           |    |    |   |         |          | P\$ 648    |
| <b>Knife Edge</b>  |             |           |    |    |   |         |          |            |
|  | 86-3072TTKH | 65½       | 72 | 30 | - | 75.5    | 5.2      | P\$ 1226   |
|  | 86-3060TTKH | 53¾       | 60 | 30 | - | 64.6    | 4.3      | P\$ 1093   |
|  | 86-3048TTKH | 41½       | 48 | 30 | - | 53.7    | 3.5      | P\$ 995    |
|  | 86-2472TTKH | 65½       | 72 | 24 | - | 62.4    | 4.2      | P\$ 1121   |
|  | 86-2460TTKH | 53¾       | 60 | 24 | - | 53.7    | 3.5      | P\$ 1004   |
|  | 86-2448TTKH | 41½       | 48 | 24 | - | 44.9    | 2.8      | P\$ 921    |
|  | 86-1872TTKH | 65½       | 72 | 18 | - | 49.3    | 3.2      | P\$ 1009   |
|  | 86-1860TTKH | 53¾       | 60 | 18 | - | 42.7    | 2.7      | P\$ 909    |
|  | 86-1848TTKH | 41½       | 48 | 18 | - | 36.2    | 2.2      | P\$ 845    |

Must Specify (in this order):  
 Model #  
 Top Finish/Color  
 Leg Model #  
 Ganging Model #  
 Nesting Model #  
 Grommet/Power/Data Location

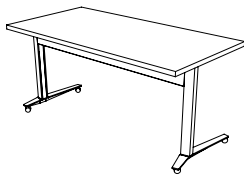

Must Order Envy C-Leg or Vantage T-Leg Base. See [Envy Details](#) and [Vantage Details](#).

**Description**

- Profile on User Side Only
- Legs Required (Assembly Required); Sold Separately, See [Envy](#) and [Vantage](#) Details
- Leg Assemblies available with Glides or Casters
- 18"D Tops Available with Envy C-Leg Base Only
- Pre-Drilled for Optional Ganging Brackets, See Below
- Optional Flip Mechanism for Nesting is Available, See Below
- Modesty Panel Standard on Envy C-Leg Base and Optional on Vantage T-Leg Base; Sold Separately, See [Envy C-Leg Base Details](#) and [Vantage T-Leg Base Details](#)
- Power & Data Options Available; Sold Separately, [See Multiple Units](#) and [See Locations](#)

**Options: Specify & Add**

**GANGING**

|           |  |       |
|-----------|--|-------|
| 08-1505GB | Ganging Bracket Kit  | \$ 77 |
|           | <ul style="list-style-type: none"> <li>• Set of 2 with Thumb Screws</li> <li>• Tops Are Pre-Drilled</li> </ul> |       |

**NESTING**

|         |  |        |
|---------|--|--------|
| 08-FLIP | Flip Mechanism for Nesting (Factory Installed) | \$ 472 |
|---------|--|--------|

T = TFL P = HPL W = Veneer

[See Tri-One Overview For Ordering Options](#)

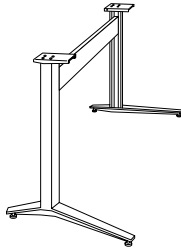
| Item   | Model No.  | Ship Wt | Cubic Ft | List Price |         |
|--|--|---------|----------|------------|---------|
| <b>ENVY C-LEG BASE ASSEMBLY FOR TRAINING TOPS</b><br><br> | <b>Large C-Leg Base Assembly: For Use with 24"D and 30"D Tops</b>        |         |          |            |         |
|  | <b>With Casters: Also Specify Soft Wheel (SOFT) or Hard Wheel (CAST)</b> |         |          |            |         |
|  | 08-2428CLC72   |         | 40       | 4.3        | \$ 1445 |
|  | For 72"W Tops  |         |          |            |         |
|  | 08-2428CLC60   |         | 36       | 3.2        | \$ 1391 |
|  | For 60"W Tops  |         |          |            |         |
|  | 08-2428CLC48   |         | 32       | 2.9        | \$ 1345 |
|  | For 48"W Tops  |         |          |            |         |
|  | <b>With Glides:</b>  |         |          |            |         |
|  | 08-2428CLG72   |         | 39       | 4.3        | \$ 1318 |
|  | For 72"W Tops  |         |          |            |         |
|  | 08-2428CLG60   |         | 35       | 3.2        | \$ 1267 |
|  | For 60"W Tops  |         |          |            |         |
|  | 08-2428CLG48   |         | 31       | 2.9        | \$ 1221 |
|  | For 48"W Tops  |         |          |            |         |
| <b>Small C-Leg Base Assembly: For Use with 18"D Tops</b>   |  |         |          |            |         |
| <b>With Casters: Also Specify Soft Wheel (SOFT) or Hard Wheel (CAST)</b>   |  |         |          |            |         |
| 08-1828CLC72   |  | 36      | 4.3      | \$ 1329    |         |
| For 72"W Tops  |  |         |          |            |         |
| 08-1828CLC60   |  | 32      | 3.2      | \$ 1278    |         |
| For 60"W Tops  |  |         |          |            |         |
| 08-1828CLC48   |  | 28      | 2.9      | \$ 1230    |         |
| For 48"W Tops  |  |         |          |            |         |
| <b>With Glides:</b>  |  |         |          |            |         |
| 08-1828CLG72   |  | 35      | 4.3      | \$ 1204    |         |
| For 72"W Tops  |  |         |          |            |         |
| 08-1828CLG60   |  | 31      | 3.2      | \$ 1154    |         |
| For 60"W Tops  |  |         |          |            |         |
| 08-1828CLG48   |  | 27      | 2.9      | \$ 1106    |         |
| For 48"W Tops  |  |         |          |            |         |

Must Specify (in this order):

Model #

Caster Type (if applicable)

**Description**

- Available in Aluminum
- Includes Trough/Modesty
- Legs Feature Removable Panel for Wire Management
- When Casters are Specified, Must Choose Soft Wheel (SOFT) or Hard Wheel (Hard)
- Caster Option Features Two Locking Casters and Two Non-Locking Casters
- Bases Are Not Available To Be Sold Separately

T = TFL P = HPL W = Veneer

[See Tri-One Overview For Ordering Options](#)

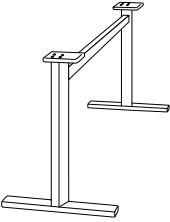
| Item  | Model No.  | Ship Wt | Cubic Ft | List Price |        |
|---|--|---------|----------|------------|--------|
| <b>VANTAGE T-LEG BASE ASSEMBLY FOR TRAINING TOPS</b><br> | <b>Large T-Leg Base Assembly: For Use with 24"D and 30"D Tops</b>        |         |          |            |        |
|   | <b>With Casters: Also Specify Soft Wheel (SOFT) or Hard Wheel (CAST)</b> |         |          |            |        |
|   | 08-2428TLC72   |         | 36       | 4.3        | \$ 692 |
|   | For 72"W Tops  |         |          |            |        |
|   | 08-2428TLC60   |         | 32       | 3.2        | \$ 661 |
|   | For 60"W Tops  |         |          |            |        |
|   | 08-2428TLC48   |         | 28       | 2.9        | \$ 634 |
|   | For 48"W Tops  |         |          |            |        |
|   | <b>With Glides:</b>  |         |          |            |        |
|   | 08-2428TLG72   |         | 35       | 4.3        | \$ 664 |
| For 72"W Tops   |  |         |          |            |        |
| 08-2428TLG60  |  | 31      | 3.2      | \$ 634     |        |
| For 60"W Tops   |  |         |          |            |        |
| 08-2428TLG48  |  | 27      | 2.9      | \$ 611     |        |
| For 48"W Tops   |  |         |          |            |        |

**Must Specify (in this order):**

Model #  
 Caster Type (if applicable)  
 Optional Modesty  
 Optional Modesty Color

**Description**

- Available in Aluminum
- Not Available for Use on 18"D Tops
- Includes Stretcher Rail
- When Casters are Specified, Must Choose Soft Wheel (SOFT) or Hard Wheel (Hard)
- Caster Option Features Two Locking Casters and Two Non-Locking Casters
- Optional 12"H Modesty Panel, See Below
- Bases Are Not Available To Be Sold Separately

**Optional Modesty Panels: Specify & Add****FIXED MODESTY: Used on Standard, Non-Nesting Tables**

|            |     |               |         |
|------------|-----|---------------|---------|
| 86-0872MD  | TFL | For 72"W Tops | T\$ 464 |
| 86-0872MDH | HPL |               | P\$ 628 |
| 86-0860MD  | TFL | For 60"W Tops | T\$ 439 |
| 86-0860MDH | HPL |               | P\$ 590 |
| 86-0848MD  | TFL | For 48" Tops  | T\$ 423 |
| 86-0848MDH | HPL |               | P\$ 574 |

**HINGED MODESTY: Used on Nesting Tables with Flip Mechanism**

|             |     |               |         |
|-------------|-----|---------------|---------|
| 86-0865HMD  | TFL | For 72"W Tops | T\$ 464 |
| 86-0865HMDH | HPL |               | P\$ 628 |
| 86-0853HMD  | TFL | For 60"W Tops | T\$ 440 |
| 86-0853HMDH | HPL |               | P\$ 595 |
| 86-0841HMD  | TFL | For 48" Tops  | T\$ 425 |
| 86-0841HMDH | HPL |               | P\$ 578 |

T = TFL P = HPL W = Veneer

[See Tri-One Overview For Ordering Options](#)

| Item   | Model No. |        | W                 | D                 | H | Ship Wt | Cubic Ft | List Price |
|--|-----------|--------|-------------------|-------------------|---|---------|----------|------------|
| <br>ROUND GROMMET COVER | 01-GRMTB  | Black  | 2 $\frac{3}{8}$ " | 2 $\frac{3}{8}$ " | - | 1       | 0.1      | \$ 33      |
|  | 01-GRMTSL | Silver | 2 $\frac{3}{8}$ " | 2 $\frac{3}{8}$ " | - | 1       | 0.1      | \$ 33      |

Open Market Only

**Description**

- 2 $\frac{3}{8}$ " (60mm) Round Grommet Cover
- Field Installed

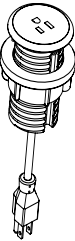
|   |             |        |   |   |   |   |     |       |
|---|-------------|--------|---|---|---|---|-----|-------|
| <br>SINGLE POWER SAND DOLLAR | 01-SAND60PW | White  | 3 | 3 | 4 | 1 | 0.2 | \$ 92 |
|   | 01-SAND60PB | Black  |   |   |   |   |     | \$ 92 |
|   | 01-SAND60PS | Silver |   |   |   |   |     | \$ 92 |

**Description**

- Unit is 2 $\frac{3}{8}$ " Diameter; Mounts in 60mm Round Grommet
- 6' Cord
- Single Power Outlet

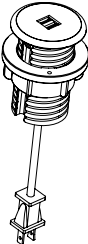
|  |             |        |   |   |   |   |     |        |
|--|-------------|--------|---|---|---|---|-----|--------|
| <br>DOUBLE USB SAND DOLLAR | 01-SAND60UW | White  | 3 | 3 | 4 | 1 | 0.2 | \$ 260 |
|  | 01-SAND60UB | Black  |   |   |   |   |     | \$ 260 |
|  | 01-SAND60US | Silver |   |   |   |   |     | \$ 260 |

**Description**

- Unit is 2 $\frac{3}{8}$ " Diameter; Mounts in 60mm Round Grommet
- 6' Cord
- Dual USB Outlets

|  |          |  |    |                   |                 |   |   |        |
|--|----------|--|----|-------------------|-----------------|---|---|--------|
| <br>WIRE MANAGEMENT CHANNEL | 01-WMGR4 |  | 16 | 1 $\frac{1}{2}$ " | $\frac{3}{4}$ " | 1 | - | \$ 109 |
|--|----------|--|----|-------------------|-----------------|---|---|--------|

**Description**

- Set of Four (4) Black Plastic Wire Management Channels
- Snap Lock Channel
- Attaches with Adhesive Strips
- Ships via UPS Only

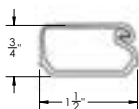

|   |           |  |                   |                   |   |   |   |       |
|---|-----------|--|-------------------|-------------------|---|---|---|-------|
| <br>CABLE GRIP | 01-WMGRCB |  | 5 $\frac{3}{8}$ " | 2 $\frac{3}{8}$ " | - | - | - | \$ 16 |
|---|-----------|--|-------------------|-------------------|---|---|---|-------|

**Description**

- Under Surface Wire Management
- Black

[See Tri-One Overview For Ordering Options](#)

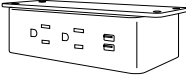
| Item  | Model No.     |        | W  | D  | H | Ship Wt | Cubic Ft | List Price |
|---|---------------|--------|----|----|---|---------|----------|------------|
|  | 01-DUOUNDERW  | White  | 6½ | 2½ | 3 | 1       | 0.2      | \$ 513     |
|   | 01-DUOUNDERB  | Black  |    |    |   |         |          | \$ 513     |
|   | 01-DUOUNDEERS | Silver |    |    |   |         |          | \$ 513     |

**Description**

- Sits Under Table Top and Includes: Two (2) Power, Two (2) USB, 10' Cord, and All Mounting Hardware
- Independent USB Circuit Controllers Deliver up to 2.1 Amps to Each Post
- FCC Part 15A, UL Approved for Horizontal and Vertical Applications
- Works with Tri-One Modular, Meeting, and Training Tables

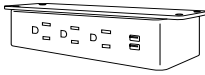
|   |               |        |   |    |   |   |     |        |
|---|---------------|--------|---|----|---|---|-----|--------|
|  | 01-TRIOUNDERW | White  | 9 | 2½ | 3 | 1 | 0.2 | \$ 615 |
|   | 01-TRIOUNDERB | Black  |   |    |   |   |     | \$ 615 |
|   | 01-TRIOUNDERS | Silver |   |    |   |   |     | \$ 615 |

**Description**

- Sits Under Table Top and Includes: Three (3), Power, Two (2) USB, One (1) Open Data, 10' Cord, and All Mounting Hardware
- HDMI, VGA, or RJ45 Accessory for Open Data Port Specified Separately, [See Data Port Options](#)
- Independent USB Circuit Controllers Deliver up to 2.1 Amps to Each Post
- FCC Part 15A, UL Approved for Horizontal and Vertical Applications
- Works with Tri-One Modular, Meeting, and Training Tables

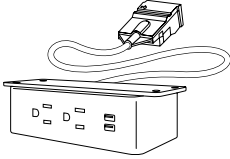
|   |                |        |    |    |   |   |     |        |
|---|----------------|--------|----|----|---|---|-----|--------|
|  | 01-PDUOUNDERW  | White  | 6½ | 2½ | 3 | 1 | 0.2 | \$ 506 |
|   | 01-PDUOUNDERB  | Black  |    |    |   |   |     | \$ 506 |
|   | 01-PDUOUNDEERS | Silver |    |    |   |   |     | \$ 506 |

**Description**

- Sits Under Table Top and Includes: Two (2) Power, Two (2) USB, 12" Cord, and All Mounting Hardware
- Requires Daisy Chain Power Box, Specified Separately, [See Details](#)
- Non-Sequential System Allows up to 8 Modules to be Connected with Jumper Cord, [See Details](#)
- Independent USB Circuit Controllers Deliver up to 2.1 Amps to Each Post
- FCC Part 15A, RU Listed and UL Recognized for Horizontal Applications
- Works with Tri-One Modular, Meeting, and Training Tables

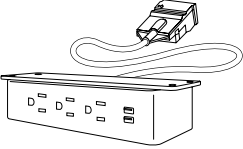
|   |                |        |   |    |   |   |     |        |
|---|----------------|--------|---|----|---|---|-----|--------|
|  | 01-PTRIOUNDERW | White  | 9 | 2½ | 3 | 1 | 0.2 | \$ 606 |
|   | 01-PTRIOUNDERB | Black  |   |    |   |   |     | \$ 606 |
|   | 01-PTRIOUNDERS | Silver |   |    |   |   |     | \$ 606 |

**Description**

- Sits Under Table Top and Includes: Three (3), Power, Two (2) USB, One (1) Open Data, 12" Cord, and All Mounting Hardware
- HDMI, VGA, or RJ45 Accessory for Open Data Port Specified Separately, [See Data Port Options](#)
- Requires Daisy Chain Power Box, Specified Separately, [See Details](#)
- Non-Sequential System Allows up to Eight (8) Modules to be Connected with Jumper Cord, [See Details](#)
- Independent USB Circuit Controllers Deliver up to 2.1 Amps to Each Post
- FCC Part 15A, RU Listed and UL Recognized for Horizontal Applications
- Works with Tri-One Modular, Meeting, and Training Tables

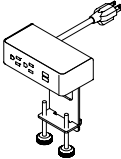
| Item   | Model No.    |        | W  | D | H | Ship Wt | Cubic Ft | List Price |
|--|--------------|--------|----|---|---|---------|----------|------------|
| <br>DUO CLAMP NEMA PLUG | 01-DUOCLAMPW | White  | 6½ | 3 | 7 | 1       | 0.2      | \$ 537     |
|  | 01-DUOCLAMPB | Black  |    |   |   |         |          | \$ 537     |
|  | 01-DUOCLAMPS | Silver |    |   |   |         |          | \$ 537     |

### Description

- Clamps to Table Top and Includes: Two (2) Power, Two (2) USB, 10' Cord, and All Mounting Hardware
- Silver Metal Trim on All Color Options
- Independent USB Circuit Controllers Deliver up to 2.1 Amps to Each Post
- FCC Part 15A, UL Approved for Horizontal and Vertical Applications
- Works with Tri-One Modular, Meeting, and Training Tables

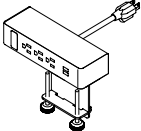
|   |               |        |   |   |   |   |     |        |
|---|---------------|--------|---|---|---|---|-----|--------|
| <br>TRIO CLAMP NEMA PLUG | 01-TRIOCLAMPW | White  | 9 | 3 | 7 | 1 | 0.2 | \$ 629 |
|   | 01-TRIOCLAMPB | Black  |   |   |   |   |     | \$ 629 |
|   | 01-TRIOCLAMPS | Silver |   |   |   |   |     | \$ 629 |

### Description

- Clamps to Table Top and Includes: Three (3), Power, Two (2) USB, One (1) Open Data, 10' Cord, and All Mounting Hardware
- HDMI, VGA, or RJ45 Accessory for Open Data Port Specified Separately, [See Data Port Options](#)
- Silver Metal Trim on All Color Options
- Independent USB Circuit Controllers Deliver up to 2.1 Amps to Each Post
- FCC Part 15A, UL Approved for Horizontal and Vertical Applications
- Works with Tri-One Modular, Meeting, and Training Tables

|  |              |        |    |    |    |   |     |        |
|--|--------------|--------|----|----|----|---|-----|--------|
| <br>DUO BEZEL NEMA PLUG | 01-DUOBEZELW | White  | 6½ | 2½ | 3¼ | 1 | 0.2 | \$ 633 |
|  | 01-DUOBEZELB | Black  |    |    |    |   |     | \$ 633 |
|  | 01-DUOBEZELS | Silver |    |    |    |   |     | \$ 633 |

### Description

- Sits on Table Top and Includes: Two (2) Power, Two (2) USB, 10' Cord, and All Mounting Hardware
- Independent USB Circuit Controllers Deliver up to 2.1 Amps to Each Post
- FCC Part 15A, UL Approved for Horizontal and Vertical Applications
- Works with Tri-One Modular, Meeting, and Training Tables

|   |               |        |   |    |   |   |     |        |
|---|---------------|--------|---|----|---|---|-----|--------|
| <br>TRIO BEZEL NEMA PLUG | 01-TRIOBEZELW | White  | 9 | 2½ | 3 | 1 | 0.2 | \$ 680 |
|   | 01-TRIOBEZELB | Black  |   |    |   |   |     | \$ 680 |
|   | 01-TRIOBEZELS | Silver |   |    |   |   |     | \$ 680 |

### Description

- Sits on Table Top and Includes: Three (3), Power, Two (2) USB, One (1) Open Data, 10' Cord, and All Mounting Hardware
- HDMI, VGA, or RJ45 Accessory for Open Data Port Specified Separately, [See Data Port Options](#)
- Independent USB Circuit Controllers Deliver up to 2.1 Amps to Each Post
- FCC Part 15A, UL Approved for Horizontal and Vertical Applications
- Works with Tri-One Modular, Meeting, and Training Tables

[See Tri-One Overview For Ordering Options](#)



| Item  | Model No.     |        | W  | D  | H | Ship Wt | Cubic Ft | List Price |
|---|---------------|--------|----|----|---|---------|----------|------------|
|  | 01-PDUOBEZELW | White  | 6½ | 2¼ | 3 | 1       | 0.2      | \$ 626     |
|   | 01-PDUOBEZELB | Black  |    |    |   |         |          | \$ 626     |
|   | 01-PDUOBEZELS | Silver |    |    |   |         |          | \$ 626     |

**Description**

- Sits on Table Top and Includes: Two (2) Power, Two (2) USB, 12” Cord, and All Mounting Hardware
- Requires Daisy Chain Power Box, Specified Separately, [See Details](#)
- Non-Sequential System Allows up to 8 Modules to be Connected with Jumper Cord, [See Details](#)
- Independent USB Circuit Controllers Deliver up to 2.1 Amps to Each Post
- FCC Part 15A, RU Listed and UL Recognized for Horizontal and Vertical Applications
- Works with Tri-One Modular, Meeting, and Training Tables

|   |                |        |   |    |   |   |     |        |
|---|----------------|--------|---|----|---|---|-----|--------|
|  | 01-PTRIOBEZELW | White  | 9 | 2¼ | 3 | 1 | 0.2 | \$ 671 |
|   | 01-PTRIOBEZELB | Black  |   |    |   |   |     | \$ 671 |
|   | 01-PTRIOBEZELS | Silver |   |    |   |   |     | \$ 671 |

**Description**

- Sits on Table Top and Includes: Three (3), Power, Two (2) USB, One (1) Open Data, 12” Cord, and All Mounting Hardware
- HDMI, VGA, or RJ45 Accessory for Open Data Port Specified Separately, See Below
- Requires Daisy Chain Power Box, Specified Separately, [See Details](#)
- Non-Sequential System Allows up to Eight (8) Modules to be Connected with Jumper Cord, [See Details](#)
- Independent USB Circuit Controllers Deliver up to 2.1 Amps to Each Post
- FCC Part 15A, RU Listed and UL Recognized for Horizontal and Vertical Applications
- Works with Tri-One Modular, Meeting, and Training Tables

|   |             |  |   |   |   |   |     |        |
|---|-------------|--|---|---|---|---|-----|--------|
| HDMI DATA PORT ACCESSORY FOR TRIO UNITS | 01-LCOMHDMI |  | - | - | - | 1 | 0.2 | \$ 155 |
|---|-------------|--|---|---|---|---|-----|--------|

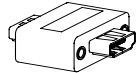

Open Market

**Description**

- HDMI Port for Trio Units

|  |            |  |   |   |   |   |     |        |
|--|------------|--|---|---|---|---|-----|--------|
| VGA DATA PORT ACCESSORY FOR TRIO UNITS | 01-LCOMVGA |  | - | - | - | 1 | 0.2 | \$ 114 |
|--|------------|--|---|---|---|---|-----|--------|

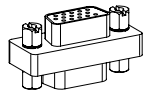

**Description**

- VGA Port for Trio Units

|   |             |  |   |   |   |   |     |       |
|---|-------------|--|---|---|---|---|-----|-------|
| RJ45 DATA PORT ACCESSORY FOR TRIO UNITS | 01-LCOMRJ45 |  | - | - | - | 1 | 0.2 | \$ 74 |
|---|-------------|--|---|---|---|---|-----|-------|

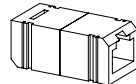

**Description**

- RJ45 Port for Trio Units

| Item  | Model No.                             | W | D | H | Ship Wt | Cubic Ft | List Price |
|---|---------------------------------------|---|---|---|---------|----------|------------|
|  DAISY CHAIN POWER BOX | 01-PPOWER                             | - | - | - | 1       | 0.2      | \$ 727     |
|   | <i>76" Perimeter, 36" Power Cord</i>  |   |   |   |         |          |            |
|   | 01-PPOWER2                            | - | - | - | 1       | 0.2      | \$ 747     |
|   | <i>24" Perimeter, 144" Power Cord</i> |   |   |   |         |          |            |

#### Description

- Powers up to Eight (8) Duo and Trio Daisy Chain Units
- One (1) Nema Plug and One (1) Daisy Chain Plug
- 12-Amp System Rating
- 15-Amp Over-Current Protection

|   |          |                 |   |   |   |   |     |        |
|---|----------|-----------------|---|---|---|---|-----|--------|
|  DAISY CHAIN JUMPER CORD | 01-6JUMP | <i>72" Long</i> | - | - | - | 1 | 0.2 | \$ 281 |
|   | 01-5JUMP | <i>60" Long</i> | - | - | - | 1 | 0.2 | \$ 266 |
|   | 01-4JUMP | <i>48" Long</i> | - | - | - | 1 | 0.2 | \$ 225 |
|   | 01-2JUMP | <i>24" Long</i> | - | - | - | 1 | 0.2 | \$ 207 |

#### Description

- Connects Duo and Trio Daisy Chain Units
- Non-Sequential System Allows up to 8 Modules to be Connected

|             |         |  |   |   |   |   |   |        |
|-------------|---------|--|---|---|---|---|---|--------|
| POWER STRIP | 01-PRSP |  | 9 | 2 | 2 | 1 | - | \$ 192 |
|-------------|---------|--|---|---|---|---|---|--------|



#### Description

- Includes Four (4) Outlets and Two (2) Phone Jacks
- Black Plastic with Rocker On/Off Switch
- 13 Amp Circuit Breaker
- 10' Power Cord and Two (2) 14' Phone Hook Up Cords
- UL and CSA Recognized
- Suitable for Surface or Recessed Mounting
- Ships via UPS Only

[See Tri-One Overview For Ordering Options](#)

**Standard Cutout Types & General Location Information**

- Grommets can be specified, at an upcharge, **add \$33** for a field installed grommet cover or **add \$72** for a factory installed grommet (unless otherwise noted).
- Power/Data Modules can be specified in standard locations at no additional charge.
- The selection of both the Power/Data Module and Base will determine cutout locations for each table size, as well as placement over or between bases.
- [See exact measurements of Module locations.](#)
- For specific locations available by table size see series pages, [see Aura/Canvas/Gesso locations](#) and [see Cameo locations](#).

**Cutout Locations Available**

**OC** = On Center  
**BB** = Between Bases (*requires 2 modules*)  
**CL** = Left of Center  
**CR** = Right of Center  
**EL** = End Left  
**ER** = End Right  
**ML** = Middle Left  
**MR** = Middle Right

**General Location of Cutouts**

*For Tables with **Two (2) Bases** and **One (1) Location**:*

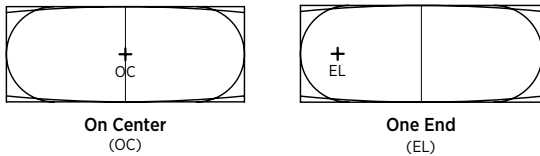

*For Tables with **Two (2) Bases** and **Two (2) Locations**:*

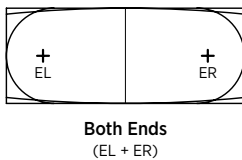

*For Tables with **Three (3) Bases** and **One (1) Location**:*

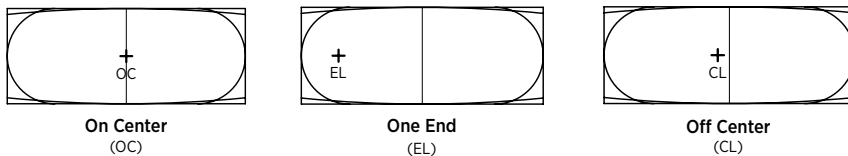

*For Tables with **Three (3) Bases** and **Two (2) Locations**:*

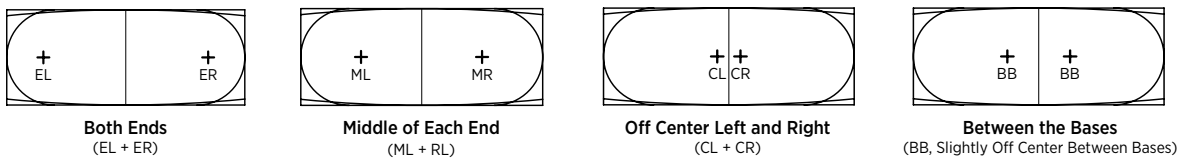

*For Tables with **Three (3) Bases** and **Three (3) Locations**:*

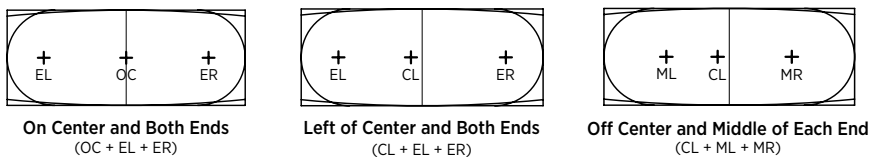

*Continued on Next Page.*

**Standard Cutout Types & General Location Information (Continued)**

- Grommets can be specified, at an upcharge, **add \$33** for a field installed grommet cover or **add \$72** for a factory installed grommet (unless otherwise noted).
- Power/Data Modules can be specified in standard locations at no additional charge.
- The selection of both the Power/Data Module and Base will determine cutout locations for each table size, as well as placement over or between bases.
- [See exact measurements of Module locations.](#)
- For specific locations available by table size see series pages, [see Aura/Canvas/Gesso locations](#) and [see Cameo locations](#).

**Cutout Locations Available**

**OC** = On Center  
**BB** = Between Bases (*requires 2 modules*)  
**CL** = Left of Center  
**CR** = Right of Center  
**EL** = End Left  
**ER** = End Right  
**ML** = Middle Left  
**MR** = Middle Right

**General Location of Cutouts**

*Continued from Previous Page*

*For Tables with **Three (3) Bases** and **Four (4) Locations**:*

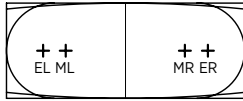

**Middle of Each End and Both Ends**  
(ML + MR + EL + ER)

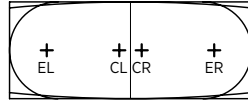

**Off Center and Both Ends**  
(CL + CR + EL + ER)

*For Tables with **Five (5) Bases** and **One (1) Location**:*

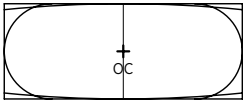

**On Center**  
(OC)

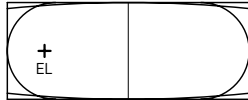

**One End**  
(EL)

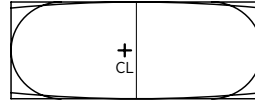

**Off Center**  
(CL)

*For Tables with **Five (5) Bases** and **Two (2) Locations**:*

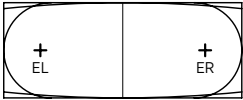

**Both Ends**  
(EL + ER)



**Middle of Each End**  
(ML + MR)

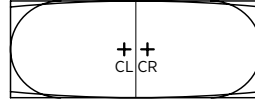

**Off Center Left and Right**  
(CL + CR)

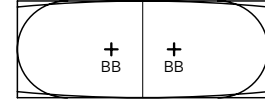

**Between the Bases**  
(BB, Slightly Off Center Between Bases)

*For Tables with **Five (5) Bases** and **Three (3) Locations**:*

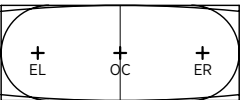

**On Center and Both Ends**  
(OC + EL + ER)

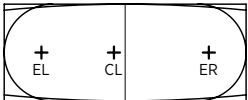

**Left of Center and Both Ends**  
(CL + EL + ER)

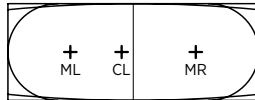

**Off Center and Middle of Each End**  
(CL + ML + MR)

*For Tables with **Five (5) Bases** and **Four (4) Locations**:*

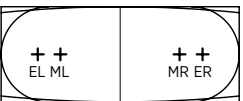



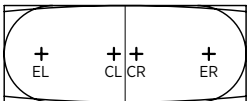



**Middle of Each End and Both Ends**  
(ML + MR + EL + ER)



**Off Center and Both Ends**  
(CL + CR + EL + ER)

**Location Measurements By Module**



|  | 72" Tops  | 96" Tops  | 120", 144" & 168" Tops  | 192" Tops  |
|--|---|---|---|--|
|  | <b>OC</b> On Center<br><b>BB</b> Between Bases (requires 2 modules) |   | <b>CL</b> Left of Center<br><b>CR</b> Right of Center   | <b>EL</b> End Left<br><b>ER</b> End Right<br><b>ML</b> Middle Left<br><b>MR</b> Middle Right   |
| <b>GROMMET</b><br>  | OC Center of Table  | OC Center of Table<br>EL, EL + ER 24½" from end | CL, CL + CR 5½" from center<br>EL, EL + ER 24½" from end<br>CL + EL + ER, 5½" from center and<br>CL + CR + EL + ER 24½" from end<br>BB Slightly off centered<br>between bases                                       | CL, CL + CR 5½" from center<br>EL, EL + ER 24½" from end<br>CL + EL + ER, 5½" from center and<br>CL + CR + EL + ER 24½" from end<br>BB Slightly off centered<br>between bases<br>ML + MR 48" from end<br>CL + ML + MR, 5½" from center and<br>CL + CR + ML + MR 48" from end   |
| <b>POWER 440</b><br><br><b>INTERACT</b><br>  | OC Center of Table  | OC Center of Table<br>EL, EL + ER 25" from end  | OC Splits seam in center<br>of bases<br>EL, EL + ER 25" from end<br>CL, CL + CR 5" from center<br>CL + EL + ER, 5" from center and<br>CL + CR + EL + ER 25" from end<br>BB Slightly off centered<br>between bases   | OC Splits seam in center<br>of bases<br>EL, EL + ER 25" from end<br>CL, CL + CR 5" from center<br>CL + EL + ER, 5" from center and<br>CL + CR + EL + ER 25" from end<br>BB Slightly off centered<br>between bases<br>ML + MR 48" from end<br>CL + ML + MR, 5" from center and<br>CL + CR + ML + MR 48" from end  |
| <b>DPORT 4A</b><br><br><b>OASIS MINI,</b><br><br><b>INTRFC1</b><br><br><b>POWER &amp; DATA VAULT</b><br> | OC Center of Table  | OC Center of Table<br>EL, EL + ER 29" from end  | OC Splits seam in center<br>of bases<br>EL, EL + ER 29" from end<br>CL + EL + ER, 9½" from center and<br>CL + CR + EL + ER 29" from end<br>CL, CL + CR 9½" from center<br>BB Slightly off centered<br>between bases | OC Splits seam in center<br>of bases<br>EL, EL + ER 29" from end<br>CL + EL + ER, 9½" from center and<br>CL + CR + EL + ER 29" from end<br>CL, CL + CR 9½" from center<br>BB Slightly off centered<br>between bases<br>ML + MR 48" from end<br>OC+ EL + ER Splits center seam<br>and 29" from end<br>OC+ ML + MR Splits center seam<br>and 48" from end<br>CL + ML + MR, 9½" from center and<br>CL + CR + ML + MR 48" from end |

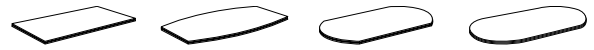















## 36"x72" TOPS

For General Location Information, [See Cut Out Locations](#); For Exact Measurements of Locations, [See Details](#).

### 36X72 TOP LOCATIONS AVAILABLE BY BASE & MODULE COMBINATION

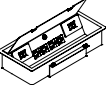
OC On Center  
BB Between Bases (requires 2 modules) CL Left of Center EL End Left ML Middle Left  
CR Right of Center ER End Right MR Middle Right

|   | METAL BASE<br> | STRUT LEGS<br> | CYLINDER<br> | RECTANGLE<br> | RECTANGULAR BOX W/DOOR<br> | CANOE<br> | V-CAPPED<br> | FLAT-CAPPED<br> |
|---|---|---|---|--|---|--|---|--|
| GROMMET<br>            | OC  | OC  | OC  | OC   | OC  | OC   | OC  | OC   |
| POWER & DATA VAULT<br> | OC  | OC  |   | OC   | OC  | OC   | OC  | OC   |
| OASIS MINI<br>       | OC  | OC  |   | OC   | OC  | OC   | OC  | OC   |
| INTERACT<br>         | OC  | OC  | OC  | OC   | OC  | OC   | OC  | OC   |
| INTRFC1<br>          | OC  | OC  | OC  | OC   | OC  | OC   | OC  | OC   |
| POWER 440<br>        | OC  | OC  | OC  | OC   | OC  | OC   | OC  | OC   |
| DPORT4A<br>          | OC  | OC  | OC  | OC   | OC  | OC   | OC  | OC   |

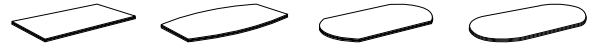















# 42"x96" TOPS

For General Location Information, [See Cut Out Locations](#); For Exact Measurements of Locations, [See Details](#).

## 42X96 TOP LOCATIONS AVAILABLE BY BASE & MODULE COMBINATION

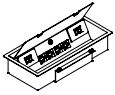
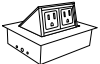
**OC** On Center      **CL** Left of Center      **EL** End Left      **ML** Middle Left  
**BB** Between Bases (requires 2 modules)      **CR** Right of Center      **ER** End Right      **MR** Middle Right

|  | METAL BASE<br> | STRUT LEGS<br> | CYLINDER<br> | RECTANGLE<br> | RECTANGULAR BOX W/DOOR<br> | CANOE<br> | V-CAPPED<br> | FLAT-CAPPED<br> |
|--|---|---|---|--|---|--|---|--|
| <b>GROMMET</b><br>                | OC  | OC<br>EL<br>EL + ER   | OC<br>EL<br>EL + ER   | OC<br>EL<br>EL + ER  | OC<br>EL<br>EL + ER   | OC<br>EL<br>EL + ER  | OC<br>EL<br>EL + ER   | OC<br>EL<br>EL + ER  |
| <b>POWER &amp; DATA VAULT</b><br> | OC  | OC<br>EL<br>EL + ER   | OC<br>EL<br>EL + ER   | OC<br>EL<br>EL + ER  | OC  | OC   | OC  | OC   |
| <b>OASIS MINI</b><br>           | OC  | OC<br>EL*<br>EL + ER*   | OC  | OC<br>EL<br>EL + ER  | OC  | OC   | OC  | OC   |
| <b>INTERACT</b><br>             | OC  | OC<br>EL<br>EL + ER   | OC<br>EL<br>EL + ER   | OC<br>EL<br>EL + ER  | OC  | OC   | OC<br>EL<br>EL + ER   | OC<br>EL<br>EL + ER  |
| <b>INTRFC1</b><br>              | OC  | OC<br>EL<br>EL + ER   | OC<br>EL<br>EL + ER   | OC<br>EL<br>EL + ER  | OC  | OC   | OC<br>EL<br>EL + ER   | OC<br>EL<br>EL + ER  |
| <b>POWER 440</b><br>            | OC  | OC<br>EL<br>EL + ER   | OC<br>EL<br>EL + ER   | OC<br>EL<br>EL + ER  | OC<br>EL<br>EL + ER   | OC   | OC<br>EL<br>EL + ER   | OC<br>EL<br>EL + ER  |
| <b>DPORT4A</b><br>              | OC  | OC<br>EL<br>EL + ER   | OC<br>EL<br>EL + ER   | OC<br>EL<br>EL + ER  | OC  | OC   | OC<br>EL<br>EL + ER   | OC<br>EL<br>EL + ER  |

\* Works on all tops except Racetrack Shaped.

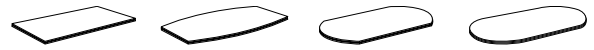















# 48"x120" TOPS

For General Location Information, [See Cut Out Locations](#); For Exact Measurements of Locations, [See Details](#).

## 48X120 TOP LOCATIONS AVAILABLE BY BASE & MODULE COMBINATION

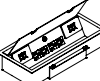
OC On Center      CL Left of Center      EL End Left      ML Middle Left  
BB Between Bases (requires 2 modules)      CR Right of Center      ER End Right      MR Middle Right

|  | METAL BASE<br> | STRUT LEGS<br> | CYLINDER<br> | RECTANGLE<br> | RECTANGULAR BOX W/DOOR<br> | CANOE<br> | V-CAPPED<br> | FLAT-CAPPED<br> |
|--|---|---|---|--|---|--|---|--|
| <b>GROMMET</b><br>                | BB  | BB<br>CL<br>CL + CR<br>EL<br>EL + ER<br>CL + EL + ER<br>CL + CR + EL + ER                       | BB<br>CL<br>EL<br>CL + CR<br>EL + ER<br>CL + EL + ER<br>CL + CR + EL + ER                     | BB<br>CL<br>CL + CR<br>EL<br>EL + ER<br>CL + EL + ER<br>CL + CR + EL + ER                      | BB<br>EL<br>EL + ER   | BB<br>EL<br>EL + ER  | BB<br>CL<br>CL + CR<br>EL<br>EL + ER<br>CL + EL + ER<br>CL + CR + EL + ER                       | BB<br>CL<br>CL + CR<br>EL<br>EL + ER<br>CL + EL + ER<br>CL + CR + EL + ER                          |
| <b>POWER &amp; DATA VAULT</b><br> | BB  | BB<br>CL<br>CL + CR<br>EL<br>EL + ER<br>CL + EL + ER<br>CL + CR + EL + ER                       | OC<br>EL<br>EL + ER<br>OC + EL + ER   | BB<br>CL<br>CL + CR<br>EL<br>EL + ER<br>CL + EL + ER<br>CL + CR + EL + ER                      | BB  | BB   | BB  | BB   |
| <b>OASIS MINI</b><br>           | BB  | BB<br>CL<br>CL + CR<br>EL<br>EL + ER<br>CL + EL + ER<br>CL + CR + EL + ER                       |   | BB<br>CL<br>CL + CR<br>EL<br>EL + ER<br>CL + EL + ER<br>CL + CR + EL + ER                      | BB  | BB   | BB  | BB   |
| <b>INTERACT</b><br>             | BB  | BB<br>CL<br>CL + CR<br>EL<br>EL + ER<br>CL + EL + ER<br>CL + CR + EL + ER                       | OC<br>EL<br>EL + ER<br>OC + EL + ER   | BB<br>CL<br>CL + CR<br>EL<br>EL + ER<br>CL + EL + ER<br>CL + CR + EL + ER                      | OC<br>BB  | BB   | OC<br>BB<br>EL<br>EL + ER<br>OC + EL + ER   | OC<br>BB<br>EL<br>EL + ER<br>OC + EL + ER  |
| <b>INTRFC1</b><br>              | BB  | BB<br>CL<br>CL + CR<br>EL<br>EL + ER<br>CL + EL + ER<br>CL + CR + EL + ER                       | OC<br>EL<br>EL + ER<br>OC + EL + ER   | BB<br>CL<br>CL + CR<br>EL<br>EL + ER<br>CL + EL + ER<br>CL + CR + EL + ER                      | BB  | BB   | OC<br>BB<br>EL<br>EL + ER<br>OC + EL + ER   | OC<br>BB<br>EL<br>EL + ER<br>OC + EL + ER  |
| <b>POWER 440</b><br>            | BB  | BB<br>CL<br>CL + CR<br>EL<br>EL + ER<br>CL + EL + ER<br>CL + CR + EL + ER                       | BB<br>CL<br>CL + CR<br>EL<br>EL + ER<br>CL + EL + ER<br>CL + CR + EL + ER                     | BB<br>CL<br>CL + CR<br>EL<br>EL + ER<br>CL + EL + ER<br>CL + CR + EL + ER                      | BB<br>EL<br>EL + ER   | BB   | BB<br>CL<br>CL + CR<br>EL<br>EL + ER<br>CL + EL + ER<br>CL + CR + EL + ER                       | BB<br>CL<br>CL + CR<br>EL<br>EL + ER<br>CL + EL + ER<br>CL + CR + EL + ER                          |
| <b>DPORT4A</b><br>              | BB  | BB<br>CL<br>CL + CR<br>EL<br>EL + ER<br>CL + EL + ER<br>CL + CR + EL + ER                       | OC<br>EL<br>EL + ER<br>OC + EL + ER   | BB<br>CL<br>CL + CR<br>EL<br>EL + ER<br>CL + EL + ER<br>CL + CR + EL + ER                      | OC<br>BB  | BB   | OC<br>BB<br>EL<br>EL + ER<br>OC + EL + ER   | OC<br>BB<br>EL<br>EL + ER<br>OC + EL + ER  |



















# 48"x144" TOPS

For General Location Information, [See Cut Out Locations](#); For Exact Measurements of Locations, [See Details](#).

## 48X144 TOP LOCATIONS AVAILABLE BY BASE & MODULE COMBINATION

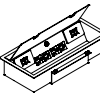
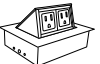
**OC** On Center      **CL** Left of Center      **EL** End Left      **ML** Middle Left  
**BB** Between Bases (requires 2 modules)      **CR** Right of Center      **ER** End Right      **MR** Middle Right

|  | METAL BASE<br> | STRUT LEGS<br> | CYLINDER<br> | RECTANGLE<br> | RECTANGULAR BOX W/DOOR<br> | CANOE<br> | V-CAPPED<br> | FLAT-CAPPED<br> |
|--|---|---|---|--|---|--|---|--|
| <b>GROMMET</b><br>                | BB  | BB<br>CL<br>CL + CR<br>EL<br>EL + ER<br>CL + EL + ER<br>CL + CR + EL + ER                       | BB<br>CL<br>CL + CR<br>EL<br>EL + ER<br>CL + EL + ER<br>CL + CR + EL + ER                     | BB<br>CL<br>CL + CR<br>EL<br>EL + ER<br>CL + EL + ER<br>CL + CR + EL + ER                      | BB<br>EL<br>EL + ER   | BB<br>EL<br>EL + ER  | BB<br>CL<br>CL + CR<br>EL<br>EL + ER<br>CL + EL + ER<br>CL + CR + EL + ER                       | BB<br>CL<br>CL + CR<br>EL<br>EL + ER<br>CL + EL + ER<br>CL + CR + EL + ER                          |
| <b>POWER &amp; DATA VAULT</b><br> | BB  | BB<br>CL<br>CL + CR<br>EL<br>EL + ER<br>CL + EL + ER<br>CL + CR + EL + ER                       | OC<br>BB<br>EL<br>EL + ER<br>OC + EL + ER   | BB<br>CL<br>CL + CR<br>EL<br>EL + ER<br>CL + EL + ER<br>CL + CR + EL + ER                      | BB  | BB   | BB  | BB   |
| <b>OASIS MINI</b><br>           | BB  | BB<br>CL<br>CL + CR<br>EL<br>EL + ER<br>CL + EL + ER<br>CL + CR + EL + ER                       | BB  | BB<br>CL<br>CL + CR<br>EL<br>EL + ER<br>CL + EL + ER<br>CL + CR + EL + ER                      | BB  | BB   | BB  | BB   |
| <b>INTERACT</b><br>             | BB  | BB<br>CL<br>CL + CR<br>EL<br>EL + ER<br>CL + EL + ER<br>CL + CR + EL + ER                       | OC<br>BB<br>EL<br>EL + ER<br>OC + EL + ER   | BB<br>CL<br>CL + CR<br>EL<br>EL + ER<br>CL + EL + ER<br>CL + CR + EL + ER                      | OC<br>BB  | BB   | OC<br>BB<br>EL<br>EL + ER<br>OC + EL + ER   | OC<br>BB<br>EL<br>EL + ER<br>OC + EL + ER  |
| <b>INTRFC1</b><br>              | BB  | BB<br>CL<br>CL + CR<br>EL<br>EL + ER<br>CL + EL + ER<br>CL + CR + EL + ER                       | OC<br>BB<br>EL<br>EL + ER<br>OC + EL + ER   | BB<br>CL<br>CL + CR<br>EL<br>EL + ER<br>CL + EL + ER<br>CL + CR + EL + ER                      | BB  | BB   | OC<br>BB<br>EL<br>EL + ER<br>OC + EL + ER   | OC<br>BB<br>EL<br>EL + ER<br>OC + EL + ER  |
| <b>POWER 440</b><br>            | BB  | BB<br>CL<br>CL + CR<br>EL<br>EL + ER<br>CL + EL + ER<br>CL + CR + EL + ER                       | BB<br>CL<br>CL + CR<br>EL<br>EL + ER<br>CL + EL + ER<br>CL + CR + EL + ER                     | BB<br>CL<br>CL + CR<br>EL<br>EL + ER<br>CL + EL + ER<br>CL + CR + EL + ER                      | BB<br>EL<br>EL + ER   | BB   | BB<br>CL<br>CL + CR<br>EL<br>EL + ER<br>CL + EL + ER<br>CL + CR + EL + ER                       | BB<br>CL<br>CL + CR<br>EL<br>EL + ER<br>CL + EL + ER<br>CL + CR + EL + ER                          |
| <b>DPORT4A</b><br>              | BB  | BB<br>CL<br>CL + CR<br>EL<br>EL + ER<br>CL + EL + ER<br>CL + CR + EL + ER                       | OC<br>BB<br>EL<br>EL + ER<br>OC + EL + ER   | BB<br>CL<br>CL + CR<br>EL<br>EL + ER<br>CL + EL + ER<br>CL + CR + EL + ER                      | OC<br>BB  | BB   | OC<br>BB<br>EL<br>EL + ER<br>OC + EL + ER   | OC<br>BB<br>EL<br>EL + ER<br>OC + EL + ER  |

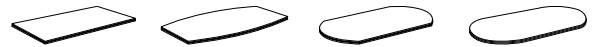















# 48"x168" TOPS

For General Location Information, [See Cut Out Locations](#); For Exact Measurements of Locations, [See Details](#).

## 48X168 TOP LOCATIONS AVAILABLE BY BASE & MODULE COMBINATION

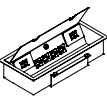
**OC** On Center      **CL** Left of Center      **EL** End Left      **ML** Middle Left  
**BB** Between Bases (requires 2 modules)      **CR** Right of Center      **ER** End Right      **MR** Middle Right

|  | METAL BASE<br> | STRUT LEGS<br> | CYLINDER<br> | RECTANGLE<br> | RECTANGULAR BOX W/DOOR<br> | CANOE<br> | V-CAPPED<br> | FLAT-CAPPED<br> |
|--|---|---|---|--|---|--|---|--|
| <b>GROMMET</b><br>                | BB  | CL<br>CL + CR<br>EL<br>EL + ER<br>CL + EL + ER<br>CL + CR + EL + ER                             | BB<br>CL<br>CL + CR<br>EL<br>EL + ER<br>CL + EL + ER<br>CL + CR + EL + ER                     | BB<br>CL<br>CL + CR<br>EL<br>EL + ER<br>CL + EL + ER<br>CL + CR + EL + ER                      | BB<br>EL<br>EL + ER   | BB<br>EL<br>EL + ER  | BB<br>CL<br>CL + CR<br>EL<br>EL + ER<br>CL + EL + ER<br>CL + CR + EL + ER                       | BB<br>CL<br>CL + CR<br>EL<br>EL + ER<br>CL + EL + ER<br>CL + CR + EL + ER                          |
| <b>POWER &amp; DATA VAULT</b><br> | BB  | OC*<br>CL<br>CL + CR<br>EL<br>EL + ER<br>CL + EL + ER<br>CL + CR + EL + ER                      | OC<br>BB<br>EL<br>EL + ER<br>OC + EL + ER   | BB<br>CL<br>CL + CR<br>EL<br>EL + ER<br>CL + EL + ER<br>CL + CR + EL + ER                      | BB  | BB   | BB  | BB   |
| <b>OASIS MINI</b><br>           | BB  | OC*<br>CL<br>CL + CR<br>EL<br>EL + ER<br>CL + EL + ER<br>CL + CR + EL + ER                      | BB  | BB<br>CL<br>CL + CR<br>EL<br>EL + ER<br>CL + EL + ER<br>CL + CR + EL + ER                      | BB  | BB   | BB  | BB   |
| <b>INTERACT</b><br>             | BB  | OC*<br>CL<br>CL + CR<br>EL<br>EL + ER<br>CL + EL + ER<br>CL + CR + EL + ER                      | OC<br>BB<br>EL<br>EL + ER<br>OC + EL + ER   | BB<br>CL<br>CL + CR<br>EL<br>EL + ER<br>CL + EL + ER<br>CL + CR + EL + ER                      | OC<br>BB  | BB   | OC<br>BB<br>EL<br>EL + ER<br>OC + EL + ER   | OC<br>BB<br>EL<br>EL + ER<br>OC + EL + ER  |
| <b>INTRFC1</b><br>              | BB  | OC*<br>CL<br>CL + CR<br>EL<br>EL + ER<br>CL + EL + ER<br>CL + CR + EL + ER                      | OC<br>BB<br>EL<br>EL + ER<br>OC + EL + ER   | BB<br>CL<br>CL + CR<br>EL<br>EL + ER<br>CL + EL + ER<br>CL + CR + EL + ER                      | BB  | BB   | OC<br>BB<br>EL<br>EL + ER<br>OC + EL + ER   | OC<br>BB<br>EL<br>EL + ER<br>OC + EL + ER  |
| <b>POWER 440</b><br>            | BB  | OC*<br>CL<br>CL + CR<br>EL<br>EL + ER<br>CL + EL + ER<br>CL + CR + EL + ER                      | BB<br>CL<br>CL + CR<br>EL<br>EL + ER<br>CL + EL + ER<br>CL + CR + EL + ER                     | BB<br>CL<br>CL + CR<br>EL<br>EL + ER<br>CL + EL + ER<br>CL + CR + EL + ER                      | BB<br>EL<br>EL + ER   | BB   | BB<br>CL<br>CL + CR<br>EL<br>EL + ER<br>CL + EL + ER<br>CL + CR + EL + ER                       | BB<br>CL<br>CL + CR<br>EL<br>EL + ER<br>CL + EL + ER<br>CL + CR + EL + ER                          |
| <b>DPORT4A</b><br>              | BB  | OC*<br>CL<br>CL + CR<br>EL<br>EL + ER<br>CL + EL + ER<br>CL + CR + EL + ER                      | OC<br>BB<br>EL<br>EL + ER<br>OC + EL + ER   | BB<br>CL<br>CL + CR<br>EL<br>EL + ER<br>CL + EL + ER<br>CL + CR + EL + ER                      | OC<br>BB  | BB   | OC<br>BB<br>EL<br>EL + ER<br>OC + EL + ER   | OC<br>BB<br>EL<br>EL + ER<br>OC + EL + ER  |

\* Works on all tops except Racetrack Shaped.

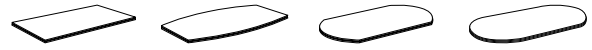

# 48"x192" TOPS

For General Location Information, [See Cut Out Locations](#); For Exact Measurements of Locations, [See Details](#).

## 48X192 TOP LOCATIONS AVAILABLE BY BASE & MODULE COMBINATION

|                                   | <b>OC</b> On Center<br><b>BB</b> Between Bases (requires 2 modules) | <b>CL</b> Left of Center<br><b>CR</b> Right of Center   | <b>EL</b> End Left<br><b>ER</b> End Right   | <b>ML</b> Middle Left<br><b>MR</b> Middle Right   |                                |                                |   |   |
|-----------------------------------|---|---|---|---|--------------------------------|--------------------------------|---|---|
|                                   | <b>METAL BASE</b>   | <b>STRUT LEGS</b>   | <b>CYLINDER</b>   | <b>RECTANGLE</b>  | <b>RECTANGULAR BOX W/DOOR</b>  | <b>CANOE</b>                   | <b>V-CAPPED</b>   | <b>FLAT-CAPPED</b>  |
| <b>GROMMET</b><br>                | BB<br>ML + MR   | CL or EL<br>CL + CR<br>EL + ER<br>ML + MR<br>CL + EL + ER<br>CL + ML + MR<br>CL + CR + EL + ER<br>CL + CR + ML + MR     | BB, CL or EL<br>CL + CR<br>EL + ER<br>ML + MR<br>CL + EL + ER<br>CL + ML + MR<br>CL + CR + EL + ER<br>CL + CR + ML + MR | CL or EL<br>CL + CR<br>EL + ER<br>ML + MR<br>CL + EL + ER<br>CL + ML + MR<br>CL + CR + EL + ER<br>CL + CR + ML + MR | BB<br>EL<br>EL + ER<br>ML + MR | BB<br>EL<br>EL + ER<br>ML + MR | BB, CL or EL<br>CL + CR<br>EL + ER<br>ML + MR<br>CL + EL + ER<br>CL + ML + MR<br>CL + CR + EL + ER<br>CL + CR + ML + MR | BB, CL or EL<br>CL + CR<br>EL + ER<br>ML + MR<br>CL + EL + ER<br>CL + ML + MR<br>CL + CR + EL + ER<br>CL + CR + ML + MR |
| <b>POWER &amp; DATA VAULT</b><br> | BB<br>ML + MR   | OC, CL or EL<br>CL + CR<br>EL + ER<br>ML + MR<br>CL + EL + ER<br>CL + ML + MR<br>CL + CR + EL + ER<br>CL + CR + ML + MR | OC<br>BB<br>EL<br>EL + ER<br>OC + EL + ER   | CL or EL<br>CL + CR<br>EL + ER<br>ML + MR<br>CL + EL + ER<br>CL + ML + MR<br>CL + CR + EL + ER<br>CL + CR + ML + MR | BB<br>ML + MR                  | BB<br>ML + MR                  | BB<br>ML + MR   | BB<br>ML + MR   |
| <b>OASIS MINI</b><br>             | BB<br>ML + MR   | OC, CL or EL<br>CL + CR<br>EL + ER<br>ML + MR<br>CL + EL + ER<br>CL + ML + MR<br>CL + CR + EL + ER<br>CL + CR + ML + MR | BB<br>ML + MR   | CL or EL<br>CL + CR<br>EL + ER<br>ML + MR<br>CL + EL + ER<br>CL + ML + MR<br>CL + CR + EL + ER<br>CL + CR + ML + MR | BB<br>ML + MR                  | BB<br>ML + MR                  | BB<br>ML + MR   | BB<br>ML + MR   |
| <b>INTERACT</b><br>               | BB<br>ML + MR   | OC, CL or EL<br>CL + CR<br>EL + ER<br>ML + MR<br>CL + EL + ER<br>CL + ML + MR<br>CL + CR + EL + ER<br>CL + CR + ML + MR | OC<br>BB<br>EL<br>EL + ER<br>ML + MR<br>OC + EL + ER<br>OC + ML + MR  | CL or EL<br>CL + CR<br>EL + ER<br>ML + MR<br>CL + EL + ER<br>CL + ML + MR<br>CL + CR + EL + ER<br>CL + CR + ML + MR | OC<br>BB<br>ML + MR            | BB<br>ML + MR                  | OC<br>BB<br>EL<br>EL + ER<br>ML + MR<br>OC + EL + ER  | OC<br>BB<br>EL<br>EL + ER<br>ML + MR<br>OC + EL + ER  |
| <b>INTRFC1</b><br>                | BB<br>ML + MR   | OC, CL or EL<br>CL + CR<br>EL + ER<br>ML + MR<br>CL + EL + ER<br>CL + ML + MR<br>CL + CR + EL + ER<br>CL + CR + ML + MR | OC<br>BB<br>EL<br>EL + ER<br>ML + MR<br>OC + EL + ER<br>OC + ML + MR  | CL or EL<br>CL + CR<br>EL + ER<br>ML + MR<br>CL + EL + ER<br>CL + ML + MR<br>CL + CR + EL + ER<br>CL + CR + ML + MR | BB<br>ML + MR                  | BB<br>ML + MR                  | OC<br>BB<br>EL<br>EL + ER<br>ML + MR<br>OC + EL + ER  | OC<br>BB<br>EL<br>EL + ER<br>ML + MR<br>OC + EL + ER  |
| <b>POWER 440</b><br>              | BB<br>ML + MR   | OC, CL or EL<br>CL + CR<br>EL + ER<br>ML + MR<br>CL + EL + ER<br>CL + ML + MR<br>CL + CR + EL + ER<br>CL + CR + ML + MR | BB, CL or EL<br>CL + CR<br>EL + ER<br>ML + MR<br>CL + EL + ER<br>CL + ML + MR<br>CL + CR + EL + ER<br>CL + CR + ML + MR | CL or EL<br>CL + CR<br>EL + ER<br>ML + MR<br>CL + EL + ER<br>CL + ML + MR<br>CL + CR + EL + ER<br>CL + CR + ML + MR | BB<br>EL<br>EL + ER<br>ML + MR | BB<br>ML + MR                  | BB, CL or EL<br>CL + CR<br>EL + ER<br>ML + MR<br>CL + EL + ER<br>CL + ML + MR<br>CL + CR + EL + ER<br>CL + CR + ML + MR | BB, CL or EL<br>CL + CR<br>EL + ER<br>ML + MR<br>CL + EL + ER<br>CL + ML + MR<br>CL + CR + EL + ER<br>CL + CR + ML + MR |
| <b>DPORT4A</b><br>                | BB<br>ML + MR   | OC, CL or EL<br>CL + CR<br>EL + ER<br>ML + MR<br>CL + EL + ER<br>CL + ML + MR<br>CL + CR + EL + ER<br>CL + CR + ML + MR | OC<br>BB<br>EL<br>EL + ER<br>ML + MR<br>OC + EL + ER<br>OC + ML + MR  | CL or EL<br>CL + CR<br>EL + ER<br>ML + MR<br>CL + EL + ER<br>CL + ML + MR<br>CL + CR + EL + ER<br>CL + CR + ML + MR | OC<br>BB<br>ML + MR            | BB<br>ML + MR                  | OC<br>BB<br>EL<br>EL + ER<br>ML + MR<br>OC + EL + ER  | OC<br>BB<br>EL<br>EL + ER<br>ML + MR<br>OC + EL + ER  |



## 36"x72" & 42"x96" TOPS

For General Location Information, [See Cut Out Locations](#); For Exact Measurements of Locations, [See Details](#).

### TOP LOCATIONS AVAILABLE BY BASE & MODULE COMBINATION

OC On Center

BB Between Bases (requires 2 modules)

CL Left of Center















CR Right of Center

EL End Left

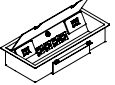
ER End Right

ML Middle Left

MR Middle Right

| 36x72  |           |        |            | 42x96  |                     |                     |            |
|--|-----------|--------|------------|--|---------------------|---------------------|------------|
|  | RECTANGLE | SQUARE | QUEEN ANNE |  | RECTANGLE           | SQUARE              | QUEEN ANNE |
| <b>GROMMET</b><br>                | OC        | OC     | OC         | <b>GROMMET</b><br>                | OC<br>EL<br>EL + ER | OC<br>EL<br>EL + ER | OC         |
| <b>POWER &amp; DATA VAULT</b><br> | OC        |        |            | <b>POWER &amp; DATA VAULT</b><br> | OC<br>EL<br>EL + ER | OC<br>EL<br>EL + ER | OC         |
| <b>OASIS MINI</b><br>           | OC        |        |            | <b>OASIS MINI</b><br>           | OC<br>EL<br>EL + ER | OC<br>EL<br>EL + ER | OC         |
| <b>INTERACT</b><br>             | OC        |        |            | <b>INTERACT</b><br>             | OC<br>EL<br>EL + ER | OC<br>EL<br>EL + ER | OC         |
| <b>INTRFC1</b><br>              | OC        |        |            | <b>INTRFC1</b><br>              | OC<br>EL<br>EL + ER | OC<br>EL<br>EL + ER | OC         |
| <b>POWER 440</b><br>            | OC        | OC     | OC         | <b>POWER 440</b><br>            | OC<br>EL<br>EL + ER | OC<br>EL<br>EL + ER | OC         |
| <b>DPORT4A</b><br>              | OC        | OC     | OC         | <b>DPORT4A</b><br>              | OC<br>EL<br>EL + ER | OC<br>EL<br>EL + ER | OC         |















# 48"x120" & 48"x144" TOPS

For General Location Information, [See Cut Out Locations](#); For Exact Measurements of Locations, [See Details](#).

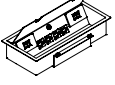
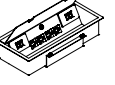
## TOP LOCATIONS AVAILABLE BY BASE & MODULE COMBINATION

**OC** On Center      **CL** Left of Center      **EL** End Left      **ML** Middle Left  
**BB** Between Bases (requires 2 modules)      **CR** Right of Center      **ER** End Right      **MR** Middle Right

| 48x120  |   |   |            | 48x144   |   |   |            |
|---|---|---|------------|--|---|---|------------|
|   | RECTANGLE   | SQUARE  | QUEEN ANNE |  | RECTANGLE   | SQUARE  | QUEEN ANNE |
| <b>GROMMET</b><br>                 | BB, CL or EL<br>CL + CR<br>EL + ER<br>CL + EL + ER<br>CL + CR + EL + ER | BB, CL or EL<br>CL + CR<br>EL + ER<br>CL + EL + ER<br>CL + CR + EL + ER | BB         | <b>GROMMET</b><br>                  | BB, CL or EL<br>CL + CR<br>EL + ER<br>CL + EL + ER<br>CL + CR + EL + ER | BB, CL or EL<br>CL + CR<br>EL + ER<br>CL + EL + ER<br>CL + CR + EL + ER | BB         |
| <b>POWER &amp; DATA VAULT</b><br> | BB, CL or EL<br>CL + CR<br>EL + ER<br>CL + EL + ER<br>CL + CR + EL + ER | OC<br>EL<br>EL + ER<br>OC + EL + ER                                     |            | <b>POWER &amp; DATA VAULT</b><br> | BB, CL or EL<br>CL + CR<br>EL + ER<br>CL + EL + ER<br>CL + CR + EL + ER | OC<br>BB<br>EL<br>EL + ER<br>OC + EL + ER                               | BB         |
| <b>OASIS MINI</b><br>            | BB, CL or EL<br>CL + CR<br>EL + ER<br>CL + EL + ER<br>CL + CR + EL + ER | OC<br>EL<br>EL + ER<br>OC + EL + ER                                     |            | <b>OASIS MINI</b><br>            | BB, CL or EL<br>CL + CR<br>EL + ER<br>CL + EL + ER<br>CL + CR + EL + ER | OC<br>BB<br>EL<br>EL + ER<br>OC + EL + ER                               | BB         |
| <b>INTERACT</b><br>              | BB, CL or EL<br>CL + CR<br>EL + ER<br>CL + EL + ER<br>CL + CR + EL + ER | OC<br>EL<br>EL + ER<br>OC + EL + ER                                     | BB         | <b>INTERACT</b><br>              | BB, CL or EL<br>CL + CR<br>EL + ER<br>CL + EL + ER<br>CL + CR + EL + ER | OC<br>BB<br>EL<br>EL + ER<br>OC + EL + ER                               | BB         |
| <b>INTRFC1</b><br>               | BB, CL or EL<br>CL + CR<br>EL + ER<br>CL + EL + ER<br>CL + CR + EL + ER | OC<br>EL<br>EL + ER<br>OC + EL + ER                                     | BB         | <b>POWER CENTER</b><br>          | BB, CL or EL<br>CL + CR<br>EL + ER<br>CL + EL + ER<br>CL + CR + EL + ER | OC<br>BB<br>EL<br>EL + ER<br>OC + EL + ER                               | BB         |
| <b>POWER 440</b><br>             | BB, CL or EL<br>CL + CR<br>EL + ER<br>CL + EL + ER<br>CL + CR + EL + ER | BB, CL or EL<br>CL + CR<br>EL + ER<br>CL + EL + ER<br>CL + CR + EL + ER | BB         | <b>POWER 440</b><br>             | BB, CL or EL<br>CL + CR<br>EL + ER<br>CL + EL + ER<br>CL + CR + EL + ER | BB, CL or EL<br>CL + CR<br>EL + ER<br>CL + EL + ER<br>CL + CR + EL + ER | BB         |
| <b>DPORT4A</b><br>               | BB, CL or EL<br>CL + CR<br>EL + ER<br>CL + EL + ER<br>CL + CR + EL + ER | OC<br>EL<br>EL + ER<br>OC + EL + ER                                     | BB         | <b>DPORT4A</b><br>               | BB, CL or EL<br>CL + CR<br>EL + ER<br>CL + EL + ER<br>CL + CR + EL + ER | OC<br>BB<br>EL<br>EL + ER<br>OC + EL + ER                               | BB         |



**48"x168" & 48"x192" TOPS**

For General Location Information, [See Cut Out Locations](#); For Exact Measurements of Locations, [See Details](#).

**TOP LOCATIONS AVAILABLE BY BASE & MODULE COMBINATION**

OC On Center

BB Between Bases (requires 2 modules)

CL Left of Center

CR Right of Center

EL End Left

ER End Right

ML Middle Left

MR Middle Right

| 48x168                            |   |   |            |
|-----------------------------------|---|---|------------|
|                                   | RECTANGLE   | SQUARE  | QUEEN ANNE |
|                                   |   |   |            |
| <b>GROMMET</b><br>                | BB, CL or EL<br>CL + CR<br>EL + ER<br>CL + EL + ER<br>CL + CR + EL + ER | BB, CL or EL<br>CL + CR<br>EL + ER<br>CL + EL + ER<br>CL + CR + EL + ER | BB         |
| <b>POWER &amp; DATA VAULT</b><br> | BB, CL or EL<br>CL + CR<br>EL + ER<br>CL + EL + ER<br>CL + CR + EL + ER | OC, BB or EL<br>EL + ER<br>OC + EL + ER                                 | BB         |
| <b>OASIS MINI</b><br>             | BB, CL or EL<br>CL + CR<br>EL + ER<br>CL + EL + ER<br>CL + CR + EL + ER | OC, BB or EL<br>EL + ER<br>OC + EL + ER                                 | BB         |
| <b>INTERACT</b><br>               | BB, CL or EL<br>CL + CR<br>EL + ER<br>CL + EL + ER<br>CL + CR + EL + ER | OC, BB or EL<br>EL + ER<br>OC + EL + ER                                 | BB         |
| <b>INTRFC1</b><br>                | BB, CL or EL<br>CL + CR<br>EL + ER<br>CL + EL + ER<br>CL + CR + EL + ER | OC, BB or EL<br>EL + ER<br>OC + EL + ER                                 | BB         |
| <b>POWER 440</b><br>              | BB, CL or EL<br>CL + CR<br>EL + ER<br>CL + EL + ER<br>CL + CR + EL + ER | BB, CL or EL<br>CL + CR<br>EL + ER<br>CL + EL + ER<br>CL + CR + EL + ER | BB         |
| <b>DPORT4A</b><br>                | BB, CL or EL<br>CL + CR<br>EL + ER<br>CL + EL + ER<br>CL + CR + EL + ER | OC, BB or EL<br>EL + ER<br>OC + EL + ER                                 | BB         |

| 48x192                            |   |   |               |
|-----------------------------------|---|---|---------------|
|                                   | RECTANGLE   | SQUARE  | QUEEN ANNE    |
|                                   |   |   |               |
| <b>GROMMET</b><br>                | CL or EL<br>CL + CR<br>EL + ER<br>ML + MR<br>CL + EL + ER<br>CL + ML + MR<br>CL + CR + EL + ER<br>CL + CR + ML + MR | BB, CL or EL<br>CL + CR<br>EL + ER<br>ML + MR<br>CL + EL + ER<br>CL + ML + MR<br>CL + CR + EL + ER<br>CL + CR + ML + MR | BB<br>ML + MR |
| <b>POWER &amp; DATA VAULT</b><br> | CL or EL<br>CL + CR<br>EL + ER<br>ML + MR<br>CL + EL + ER<br>CL + ML + MR<br>CL + CR + EL + ER<br>CL + CR + ML + MR | OC, BB or EL<br>EL + ER<br>ML + MR<br>OC + EL + ER<br>OC + ML + MR  | BB<br>ML + MR |
| <b>OASIS MINI</b><br>             | CL or EL<br>CL + CR<br>EL + ER<br>ML + MR<br>CL + EL + ER<br>CL + ML + MR<br>CL + CR + EL + ER<br>CL + CR + ML + MR | OC, BB or EL<br>EL + ER<br>ML + MR<br>OC + EL + ER<br>OC + ML + MR  | BB<br>ML + MR |
| <b>INTERACT</b><br>               | CL or EL<br>CL + CR<br>EL + ER<br>ML + MR<br>CL + EL + ER<br>CL + ML + MR<br>CL + CR + EL + ER<br>CL + CR + ML + MR | OC, BB or EL<br>EL + ER<br>ML + MR<br>OC + EL + ER<br>OC + ML + MR  | BB<br>ML + MR |
| <b>INTRFC1</b><br>                | CL or EL<br>CL + CR<br>EL + ER<br>ML + MR<br>CL + EL + ER<br>CL + ML + MR<br>CL + CR + EL + ER<br>CL + CR + ML + MR | OC, BB or EL<br>EL + ER<br>ML + MR<br>OC + EL + ER<br>OC + ML + MR  | BB<br>ML + MR |
| <b>POWER 440</b><br>              | CL or EL<br>CL + CR<br>EL + ER<br>ML + MR<br>CL + EL + ER<br>CL + ML + MR<br>CL + CR + EL + ER<br>CL + CR + ML + MR | BB, CL or EL<br>CL + CR<br>EL + ER<br>ML + MR<br>CL + EL + ER<br>CL + ML + MR<br>CL + CR + EL + ER<br>CL + CR + ML + MR | BB<br>ML + MR |
| <b>DPORT4A</b><br>                | CL or EL<br>CL + CR<br>EL + ER<br>ML + MR<br>CL + EL + ER<br>CL + ML + MR<br>CL + CR + EL + ER<br>CL + CR + ML + MR | OC, BB or EL<br>EL + ER<br>ML + MR<br>OC + EL + ER<br>OC + ML + MR  | BB<br>ML + MR |







# Occasional Tables

## SURFACE MATERIAL DIGITAL IMAGES & BROCHURE

The finishes represented on Indiana Furniture's Surface Material Finish Brochure were reproduced using the finest technology available. Samples of our finishes and laminates are available for order through our Collateral Store. Please verify your desired finish before ordering as such orders are not subject to return to Indiana Furniture.

Contact your local Indiana Furniture Sales Representative or our Customer Service team should you need assistance.

## GLIDES

All tables ship with non-marring glides, some series offering leveling glides as standard. See pricing pages for each series for more information.

## FINISH

Indiana Furniture standard occasional table finishes correspond to casegoods and conferencing finishes and laminates. Minor variations in finish color and value may occur due to the natural characteristics of wood. Consult this price list for specific finish availability within each series.

**Special Finishes:** Indiana Furniture is able to accommodate our customer's needs for specific finish matches. Please submit a 3"x5" sample panel to Customer Service for quotation and lead time.

An overview of our finishes and laminate options can be found on the inside of the back cover of this price list.

Arlington offers all the grace and embellishments associated with traditional styling with an added emphasis on value. Finely crafted in select solids with walnut and cherry veneers and high pressure laminate worksurfaces, Arlington ensures quality and expert craftsmanship with a selection of configurations for today's functional workspaces.

**CONSTRUCTION**

- Veneers on exposed surfaces feature select grade, plain sliced American Black Walnut or Cherry veneers, carefully selected and matched to assure proper balance and consistency
- Veneer tops have a 5-ply balanced construction, 1 3/16" thick with solid hardwood rims with butt corners
- HPL tops have a 3-ply balanced construction, 1 3/16" thick, with solid hardwood rims with butt corners
- Grain direction runs left to right
- All units ship with heavy duty, adjustable leveling glides to ensure proper leveling and compensation for uneven floors
- Shipped KD; Some Assembly Required

**HOW TO ORDER EXAMPLE**

| Model No. | Description  | Example |
|-----------|--------------|---------|
| 29-2124ET | Top Material | W       |
|           | Finish       | CO      |

**VENEER (W) OPTIONS**

Veneer features UVAdvantage, an ultra-violet finish, on all exposed surfaces by utilizing roll-coat UV technology. Apron rails and legs feature multi-step, hand-finished catalyzed finish.

|     |                    |     |                     |
|-----|--------------------|-----|---------------------|
| AW  | Artisan Walnut     | HW  | Harvest Walnut      |
| CO  | Columbian Walnut   | LW  | Legacy Walnut       |
| DC  | Dark Cherry        | MW  | Mahogany Walnut     |
| DFW | Dark Forest Walnut | SCH | Select Cherry       |
| EW  | Espresso           | SKC | Shaker Cherry       |
| GC  | Golden Cherry      | WC  | Williamsburg Cherry |

**HPL (P) TOP OPTIONS**

**WOODGRAIN**

|    |                  |     |                     |
|----|------------------|-----|---------------------|
| CO | Columbian Walnut | SCH | Select Cherry       |
| EF | Espresso         | SKC | Shaker Cherry       |
| GC | Golden Cherry    | WC  | Williamsburg Cherry |
| MW | Mahogany Walnut  |     |                     |

**TABLE EDGE PROFILE**



Arlington

**CERTIFICATIONS & COMPLIANCE**

- Intertek Sustainability Certified
- BIFMA level® Certified
- BIFMA Compliant® Certified
- TSCA Title VI (CARB) Compliance
- US Green Building's LEED® Contribution

**STATEMENT OF LINE**



29-2124ET:  
End Table  
[\(See Details\)](#)

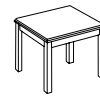

29-2424LT:  
Lamp Table  
[\(See Details\)](#)



29-3636MT:  
Square Magazine  
Table  
[\(See Details\)](#)

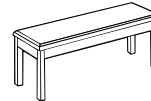

29-1847MT:  
Magazine Table  
[\(See Details\)](#)

| Item      | Model No. | W  | D  | H   | Ship Wt | Cubic Ft | List Price |          |
|-----------|-----------|----|----|-----|---------|----------|------------|----------|
| END TABLE | 29-2124ET | 21 | 24 | 21½ | 25      | 2.0      | P\$ 963    | W\$ 1123 |

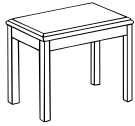

Must Specify (in this order):

- Model #
- Top Material
- Finish/Color

**Description**

- Available with Veneer (W) or HPL (P) Top, Must Specify
- Hardwood Legs
- Shipped KD; Some Assembly Required

|            |           |    |    |     |    |     |          |          |
|------------|-----------|----|----|-----|----|-----|----------|----------|
| LAMP TABLE | 29-2424LT | 24 | 24 | 21½ | 25 | 2.0 | P\$ 1078 | W\$ 1156 |
|------------|-----------|----|----|-----|----|-----|----------|----------|

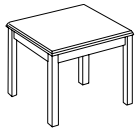

Must Specify (in this order):

- Model #
- Top Material
- Finish/Color

**Description**

- Available with Veneer (W) or HPL (P) Top, Must Specify
- Hardwood Legs
- Shipped KD; Some Assembly Required

|                |           |    |    |    |    |     |          |          |
|----------------|-----------|----|----|----|----|-----|----------|----------|
| MAGAZINE TABLE | 29-1847MT | 47 | 18 | 16 | 47 | 3.4 | P\$ 1156 | W\$ 1349 |
|----------------|-----------|----|----|----|----|-----|----------|----------|

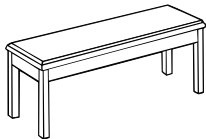

Must Specify (in this order):

- Model #
- Top Material
- Finish/Color
- Leg

**Description**

- Available with Veneer (W) or HPL (P) Top, Must Specify
- Left to Right Grain Direction on Worksurface
- Hardwood Legs
- Shipped KD; Some Assembly Required
- Optional 30" Legs; See Below

**Desk Base Molding Options: Must Specify and Add**

|       |                     |        |
|-------|---------------------|--------|
| SH-36 | Optional 30" H Legs | \$ 209 |
|-------|---------------------|--------|

|                       |           |    |    |    |    |     |          |          |
|-----------------------|-----------|----|----|----|----|-----|----------|----------|
| SQUARE MAGAZINE TABLE | 29-3636MT | 36 | 36 | 16 | 60 | 5.5 | P\$ 1235 | W\$ 1443 |
|-----------------------|-----------|----|----|----|----|-----|----------|----------|

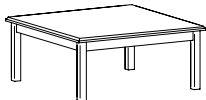

Must Specify (in this order):

- Model #
- Top Material
- Finish/Color

**Description**

- Available with Veneer (W) or HPL (P) Top, Must Specify
- Hardwood Legs
- Shipped KD; Some Assembly Required



Wilmington/Arlington

P = HPL W = Veneer

[See Intro Overview For Ordering Options](#)

From lounge areas, to private office, to conference settings, the Bailey Collection can make a statement. Bailey tables are offered in square and rectangular cocktail tables, as well as end tables, in a wide range of veneers and laminates with two edge profiles. Pair Bailey tables with the collection's chairs, settees, sofas, and ottomans.

### CONSTRUCTION

- Bases for tables are manufactured using steel frames with a chrome finish
- The wood veneer tops are made of select grade sliced Black Walnut, Cherry, Maple, or composite veneers for maximum grain and color consistency
- Veneer tops are ¾" with 1mm veneer edge bands
- Laminate tops are ¾" with 1mm PVC edge bands
- Ships fully assembled

### HOW TO ORDER EXAMPLE

| Model No.  | Description | Example |
|------------|-------------|---------|
| 720-3030SQ | Finish      | TK      |

### TFL (T) AND HPL (P) LAMINATE OPTIONS

#### WOODGRAIN

|     |                  |     |                     |
|-----|------------------|-----|---------------------|
| AS  | Asian Night      | PNW | Pinnacle Walnut     |
| BW  | Beigewood        | SCH | Select Cherry       |
| CO  | Columbian Walnut | SKC | Shaker Cherry       |
| EF  | Espresso         | SBP | Smoky Brown Pear    |
| GC  | Golden Cherry    | TK  | Studio Teak         |
| HVM | Harvest Maple    | SM  | Sugar Maple         |
| MW  | Mahogany Walnut  | WTA | Weathered Ash       |
| ORW | Oak Riftwood     | WC  | Williamsburg Cherry |

#### SOLID

|     |                |     |            |
|-----|----------------|-----|------------|
| BL  | Black          | PPD | Pepperdust |
| WH  | Designer White | SG  | Slate Grey |
| FHG | Fashion Grey   | WHS | White Sand |

### VENEER (W) OPTIONS AVAILABLE

Veneer tops feature UVAdvantage, an ultra-violet finish, on all exposed surfaces by utilizing roll-coat UV technology.

|     |                    |     |                     |
|-----|--------------------|-----|---------------------|
| AW  | Artisan Walnut     | MW  | Mahogany Walnut     |
| AS  | Asian Night        | MO  | Medium Oak*         |
| CO  | Columbian Walnut   | ORW | Oak Riftwood*       |
| DC  | Dark Cherry        | SCH | Select Cherry       |
| DFW | Dark Forest Walnut | SKC | Shaker Cherry       |
| EF  | Espresso           | SBP | Smoky Brown Pear    |
| FO  | Fawn Oak*          | SM  | Sugar Maple         |
| GC  | Golden Cherry      | SW  | Sunglow Walnut      |
| HVM | Harvest Maple      | WTA | Weathered Ash*      |
| HW  | Harvest Walnut     | WC  | Williamsburg Cherry |
| LW  | Legacy Walnut      |     |                     |

\* Finish is Low Sheen

### TABLE EDGE PROFILES

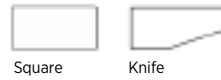

### CERTIFICATIONS & COMPLIANCE

- Intertek Sustainability Certified
- BIFMA level® Certified
- BIFMA Compliant® Certified
- TSCA Title VI (CARB) Compliance
- US Green Building's LEED® Contribution

### STATEMENT OF LINE

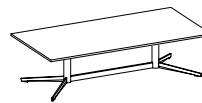

Rectangular  
Cocktail Tables  
[\(See Details\)](#)

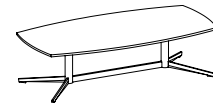

Soft Rectangular  
Cocktail Tables  
[\(See Details\)](#)



Square  
Cocktail Tables  
[\(See Details\)](#)



Soft Square  
Cocktail Tables  
[\(See Details\)](#)



Square  
End Tables  
[\(See Details\)](#)

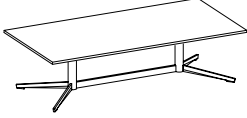
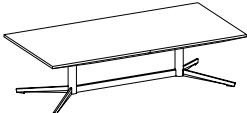

Soft Square  
End Tables  
[\(See Details\)](#)

| Item   | Model No.          |      | W  | D  | H    | Ship Wt | Cubic Ft | List Price |      |  |
|--|--------------------|------|----|----|------|---------|----------|------------|------|--|
| RECTANGULAR COCKTAIL TABLE<br><br><br> | <b>SQUARE EDGE</b> |      |    |    |      |         |          |            |      |  |
|  | 720-2550RT         | TFL  | 25 | 50 | 14   | 34.9    | 3.2      | T\$        | 1350 |  |
|  | 720-2550RTH        | HPL  | 25 | 50 | 14   | 34.9    | 3.2      | P\$        | 1586 |  |
|  | 719-2550RT         | Wood | 25 | 50 | 14   | 34.9    | 3.2      | W\$        | 1918 |  |
|  | <b>KNIFE EDGE</b>  |      |    |    |      |         |          |            |      |  |
|  | 720-2550RTKH       | HPL  | 25 | 50 | 14   | 34.9    | 3.2      | P\$        | 1966 |  |
| 719-2550RTK  | Wood               | 25   | 50 | 14 | 34.9 | 3.2     | W\$      | 2059       |      |  |

Must Specify (in this order):

Model #  
Finish/Color

#### Description

- Standard with: Chrome Base
- Table Ships Fully Assembled

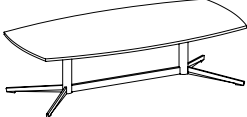
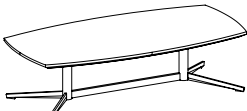
| Item   | Model No.          |      | W  | D  | H    | Ship Wt | Cubic Ft | List Price |      |  |
|--|--------------------|------|----|----|------|---------|----------|------------|------|--|
| SOFT RECTANGULAR<br>COCKTAIL TABLE<br><br><br> | <b>SQUARE EDGE</b> |      |    |    |      |         |          |            |      |  |
|  | 720-2550SRT        | TFL  | 25 | 50 | 14   | 34.9    | 3.2      | T\$        | 1350 |  |
|  | 720-2550SRTH       | HPL  | 25 | 50 | 14   | 34.9    | 3.2      | P\$        | 1586 |  |
|  | 719-2550SRT        | Wood | 25 | 50 | 14   | 34.9    | 3.2      | W\$        | 1918 |  |
|  | <b>KNIFE EDGE</b>  |      |    |    |      |         |          |            |      |  |
|  | 720-2550SRTKH      | HPL  | 25 | 50 | 14   | 34.9    | 3.2      | P\$        | 1966 |  |
| 719-2550SRTK   | Wood               | 25   | 50 | 14 | 34.9 | 3.2     | W\$      | 2059       |      |  |

Must Specify (in this order):

Model #  
Finish/Color

#### Description

- Standard with: Chrome Base
- Table Ships Fully Assembled





Square



Knife

T = TFL P = HPL W = Veneer

[See Intro Overview For Ordering Options](#)



| Item   | Model No.          |      | W  | D  | H    | Ship Wt | Cubic Ft | List Price |      |  |
|--|--------------------|------|----|----|------|---------|----------|------------|------|--|
| <b>SQUARE COCKTAIL TABLE</b><br><br><br><br> | <b>SQUARE EDGE</b> |      |    |    |      |         |          |            |      |  |
|  | 720-3030SQ         | TFL  | 30 | 30 | 14   | 29.7    | 2.80     | T\$        | 838  |  |
|  | 720-3030SQH        | HPL  | 30 | 30 | 14   | 29.7    | 2.80     | P\$        | 1137 |  |
|  | 719-3030SQ         | Wood | 30 | 30 | 14   | 29.7    | 2.80     | W\$        | 1319 |  |
|  | <b>KNIFE EDGE</b>  |      |    |    |      |         |          |            |      |  |
|  | 720-3030SQKH       | HPL  | 30 | 30 | 14   | 29.7    | 2.80     | P\$        | 1433 |  |
| 719-3030SQK  | Wood               | 30   | 30 | 14 | 29.7 | 2.80    | W\$      | 1435       |      |  |

Must Specify (in this order):

Model #  
Finish/Color

**Description**

- Standard with: Chrome Base
- Table Ships Fully Assembled

| Item  | Model No.          |      | W  | D  | H    | Ship Wt | Cubic Ft | List Price |      |  |
|---|--------------------|------|----|----|------|---------|----------|------------|------|--|
| <b>SOFT SQUARE COCKTAIL TABLE</b><br><br><br><br> | <b>SQUARE EDGE</b> |      |    |    |      |         |          |            |      |  |
|   | 720-3030SSQ        | TFL  | 30 | 30 | 14   | 29.7    | 2.80     | T\$        | 838  |  |
|   | 720-3030SSQH       | HPL  | 30 | 30 | 14   | 29.7    | 2.80     | P\$        | 1137 |  |
|   | 719-3030SSQ        | Wood | 30 | 30 | 14   | 29.7    | 2.80     | W\$        | 1319 |  |
|   | <b>KNIFE EDGE</b>  |      |    |    |      |         |          |            |      |  |
|   | 720-3030SSQKH      | HPL  | 30 | 30 | 14   | 29.7    | 2.80     | P\$        | 1433 |  |
| 719-3030SSQK  | Wood               | 30   | 30 | 14 | 29.7 | 2.80    | W\$      | 1435       |      |  |

Must Specify (in this order):

Model #  
Finish/Color

**Description**

- Standard with: Chrome Base
- Table Ships Fully Assembled



Square



Knife

T = TFL P = HPL W = Veneer

[See Intro Overview For Ordering Options](#)

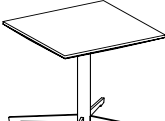
| Item  | Model No.          |      | W  | D  | H  | Ship Wt | Cubic Ft | List Price |      |
|---|--------------------|------|----|----|----|---------|----------|------------|------|
|  | <b>SQUARE EDGE</b> |      |    |    |    |         |          |            |      |
|   | 720-2020ET         | TFL  | 20 | 20 | 20 | 20      | 2.0      | T\$        | 916  |
|   | 720-2020ETH        | HPL  | 20 | 20 | 20 | 20      | 2.0      | P\$        | 1136 |
|   | 719-2020ET         | Wood | 20 | 20 | 20 | 20      | 2.0      | W\$        | 1205 |
|  | <b>KNIFE EDGE</b>  |      |    |    |    |         |          |            |      |
|   | 720-2020ETKH       | HPL  | 20 | 20 | 20 | 20      | 2.0      | P\$        | 1265 |
|   | 719-2020ETK        | Wood | 20 | 20 | 20 | 20      | 2.0      | W\$        | 1323 |

**Description**

- Standard with: Chrome Base
- Table Ships Fully Assembled

Must Specify (in this order):  
Model #  
Finish/Color

| Item  | Model No.          |      | W  | D  | H  | Ship Wt | Cubic Ft | List Price |      |
|---|--------------------|------|----|----|----|---------|----------|------------|------|
|  | <b>SQUARE EDGE</b> |      |    |    |    |         |          |            |      |
|   | 720-2020SET        | TFL  | 20 | 20 | 20 | 20      | 2.0      | T\$        | 916  |
|   | 720-2020SETH       | HPL  | 20 | 20 | 20 | 20      | 2.0      | P\$        | 1136 |
|   | 719-2020SET        | Wood | 20 | 20 | 20 | 20      | 2.0      | W\$        | 1205 |
|  | <b>KNIFE EDGE</b>  |      |    |    |    |         |          |            |      |
|   | 720-2020SETKH      | HPL  | 20 | 20 | 20 | 20      | 2.0      | P\$        | 1265 |
|   | 719-2020SETK       | Wood | 20 | 20 | 20 | 20      | 2.0      | W\$        | 1323 |

**Description**

- Standard with: Chrome Base
- Table Ships Fully Assembled

Must Specify (in this order):  
Model #  
Finish/Color

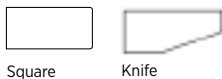

T = TFL P = HPL W = Veneer

[See Intro Overview For Ordering Options](#)



The Britta Collection showcases a Mid-Century Scandinavian aesthetic with an appealing contemporary feel. Available in two edge styles and a broad range of finishes to create an inviting space with warm and energetic sensibility. Pair Britta tables with the collection's guest, single lounge, and settee options, which all feature a wall-saver design, to create an entire setting.

### CONSTRUCTION

- The wood veneer table tops are 1" thick and are made of select grade sliced Walnut, Cherry, or Maple veneers for maximum grain and color consistency
- The knife edge profile features a 5-ply balanced construction with a solid hardwood rim; the square edge profile features a 3-ply balanced construction with a 3mm veneer edge band
- The aprons and legs are solid maple hardwood and ship with adjustable glides
- Ships fully assembled

### HOW TO ORDER EXAMPLE

| Model No.  | Description            | Example  |
|------------|------------------------|----------|
| 231-1818ET | Finish<br>Edge Profile | DFW<br>K |

### VENEER (W) OPTIONS

Veneer tops feature UVAdvantage, an ultra-violet finish, on all exposed surfaces by utilizing roll-coat UV technology. Apron rails and legs feature multi-step, hand-finished catalyzed finish.

|     |                    |     |                     |
|-----|--------------------|-----|---------------------|
| AW  | Artisan Walnut     | HW  | Harvest Walnut      |
| CO  | Columbian Walnut   | LW  | Legacy Walnut       |
| DC  | Dark Cherry        | MW  | Mahogany Walnut     |
| DFW | Dark Forest Walnut | SCH | Select Cherry       |
| EF  | Espresso           | SKC | Shaker Cherry       |
| GC  | Golden Cherry      | SM  | Sugar Maple         |
| HVM | Harvest Maple      | WC  | Williamsburg Cherry |

### TABLE EDGE PROFILE

|   |             |
|---|-------------|
| Y | Square Edge |
| K | Knife Edge  |



Square



Knife

### CERTIFICATIONS & COMPLIANCE

- Intertek Sustainability Certified
- BIFMA level® Certified
- BIFMA Compliant® Certified
- TSCA Title VI (CARB) Compliance
- US Green Building's LEED® Contribution

### STATEMENT OF LINE



231-1818ET: Square  
End Table  
[\(See Details\)](#)



231-2323SCT: Square  
Cocktail Table  
[\(See Details\)](#)



231-4723RCT: Rectangular  
Cocktail Table  
[\(See Details\)](#)

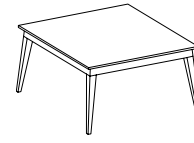

231-3535SCT: Square  
Cocktail Table  
[\(See Details\)](#)

| Item      | Model No.  |             | W  | D  | H  | Ship Wt | Cubic Ft | List Price |      |
|-----------|------------|-------------|----|----|----|---------|----------|------------|------|
| END TABLE | 231-1818ET | Square Edge | 18 | 18 | 20 | 18      | 10.8     | Y\$        | 1349 |
|           |            | Knife Edge  |    |    |    |         |          | K\$        | 1726 |



Must Specify (in this order):  
Model #  
Finish  
Edge

**Description**

- Standard with: Adjustable Glides
- Available with [Square \(Y\)](#) or [Knife \(K\) Edge](#); Must Specify
- Ships Fully Assembled

|                             |             |             |    |    |    |    |      |     |      |
|-----------------------------|-------------|-------------|----|----|----|----|------|-----|------|
| SMALL SQUARE COCKTAIL TABLE | 231-2323SCT | Square Edge | 23 | 23 | 16 | 21 | 10.8 | Y\$ | 1379 |
|                             |             | Knife Edge  |    |    |    |    |      | K\$ | 1767 |



Must Specify (in this order):  
Model #  
Finish  
Edge

**Description**

- Standard with: Adjustable Glides
- Available with [Square \(Y\)](#) or [Knife \(K\) Edge](#); Must Specify
- Ships Fully Assembled

|                       |             |             |                  |                  |    |    |      |     |      |
|-----------------------|-------------|-------------|------------------|------------------|----|----|------|-----|------|
| SQUARE COCKTAIL TABLE | 231-3535SCT | Square Edge | 34 $\frac{7}{8}$ | 34 $\frac{7}{8}$ | 16 | 45 | 25.7 | Y\$ | 1652 |
|                       |             | Knife Edge  |                  |                  |    |    |      | K\$ | 2122 |

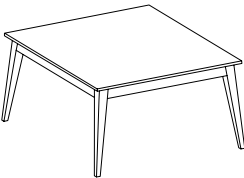

Must Specify (in this order):  
Model #  
Finish  
Edge

**Description**

- Standard with: Adjustable Glides
- Available with [Square \(Y\)](#) or [Knife \(K\) Edge](#); Must Specify
- Ships Fully Assembled

|                            |             |             |                  |    |    |    |      |     |      |
|----------------------------|-------------|-------------|------------------|----|----|----|------|-----|------|
| RECTANGULAR COCKTAIL TABLE | 231-4723RCT | Square Edge | 46 $\frac{7}{8}$ | 23 | 16 | 36 | 23.1 | Y\$ | 1617 |
|                            |             | Knife Edge  |                  |    |    |    |      | K\$ | 2080 |

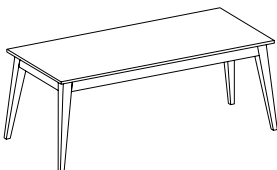

Must Specify (in this order):  
Model #  
Finish  
Edge

**Description**

- Standard with: Adjustable Glides
- Available with [Square \(Y\)](#) or [Knife \(K\) Edge](#); Must Specify
- Ships Fully Assembled



Square



Knife

[See Intro Overview For Ordering Options](#)

Always stylish, comfortable and effortlessly adaptable, Canvas enlivens environments with refined aesthetics. Project a fresh, polished attitude with our enhanced selection of multidimensional components. Your creation of an ultra-functional workspace is limited only by your imagination.

### CONSTRUCTION

- Exposed surfaces are produced from wood-grained or solid color laminates fused to a particle-board core.
- TFL chassis are fastened by screws and heavy-duty metal fasteners
- Tops are 1" thick thermally-fused (TFL) or high-pressure (HPL) laminate using 3mm PVC rims on profiled edges Grain direction runs left to right
- Slab ends come standard with adjustable levelers
- Ships fully assembled

### HOW TO ORDER EXAMPLE

| Model No. | Description   | Example |
|-----------|---------------|---------|
| 66-2424ET | Top Material  | T       |
|           | Top Color     | PPD     |
|           | Edge Profile  | F       |
|           | Chassis Color | WTA     |

### TFL (T) AND HPL (P) LAMINATE OPTIONS

#### WOODGRAIN

|     |                  |     |                     |
|-----|------------------|-----|---------------------|
| AS  | Asian Night      | PNW | Pinnacle Walnut     |
| BW  | Beigewood        | SCH | Select Cherry       |
| CO  | Columbian Walnut | SKC | Shaker Cherry       |
| EF  | Espresso         | SBP | Smoky Brown Pear    |
| GC  | Golden Cherry    | TK  | Studio Teak         |
| HVM | Harvest Maple    | SM  | Sugar Maple         |
| MW  | Mahogany Walnut  | WTA | Weathered Ash       |
| ORW | Oak Riftwood     | WC  | Williamsburg Cherry |

#### SOLID

|     |                |     |            |
|-----|----------------|-----|------------|
| BL  | Black          | PPD | Pepperdust |
| WH  | Designer White | SG  | Slate Grey |
| FHG | Fashion Grey   | WHS | White Sand |

### TABLE EDGE PROFILE

|   |             |
|---|-------------|
| F | Double Kerf |
| G | Duo         |
| X | Flute       |
| Y | Square      |

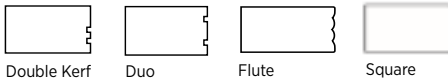

Double Kerf

Duo

Flute

Square

### CERTIFICATIONS & COMPLIANCE

- Intertek Sustainability Certified
- BIFMA level® Certified
- BIFMA Compliant® Certified
- TSCA Title VI (CARB) Compliance
- US Green Building's LEED® Contribution

### STATEMENT OF LINE

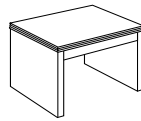

66-2424ET:  
End Table  
[\(See Details\)](#)

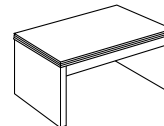

66-2442MT:  
Magazine Table  
[\(See Details\)](#)

| Item      | Model No. |     | W  | D  | H  | Ship Wt | Cubic Ft | List Price |      |
|-----------|-----------|-----|----|----|----|---------|----------|------------|------|
| END TABLE | 66-2424ET | TFL | 24 | 24 | 22 | 65      | 9.4      | T\$        | 921  |
|           |           | HPL |    |    |    |         |          | P\$        | 1058 |

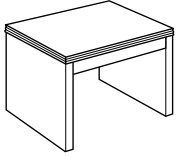

Must Specify (in this order):

- Model #
- Top Material
- Top Color
- Edge
- Chassis Color

**Description**

- Standard with: TFL Slab Ends and Apron Rail, with Adjustable Glides
- Available in Contrasting Top and Chassis Color
- Choose from TFL (T) or HPL (P) Top
- Ships Fully Assembled

|                |           |     |    |    |    |    |      |     |      |
|----------------|-----------|-----|----|----|----|----|------|-----|------|
| MAGAZINE TABLE | 66-2442MT | TFL | 42 | 24 | 16 | 70 | 11.9 | T\$ | 971  |
|                |           | HPL |    |    |    |    |      | P\$ | 1137 |

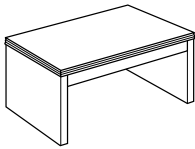

Must Specify (in this order):

- Model #
- Top Material
- Top Color
- Edge
- Chassis Color

**Description**

- Standard with: TFL Slab Ends and Apron Rail, with Adjustable Glides
- Available in Contrasting Top and Chassis Color
- Choose from TFL (T) or HPL (P) Top
- Ships Fully Assembled

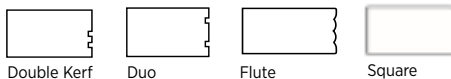

Double Kerf

Duo

Flute

Square

T=TFL P=HPL

[See Intro Overview For Ordering Options](#)

Carefully matched select veneer tops with solid hardwood legs and aprons form a collection of beautiful wood tables suitable for nearly any application.

### CONSTRUCTION

- Constructed of a 5-ply veneer top, 1½" thick
- Legs are solid Maple hardwood and ship with nylon glides
- Aprons are steam bent with Maple veneer faces
- Grain direction runs left to right
- Elliptical Magazine and Rounded End Tables ship fully assembled; all other models require some assembly

### HOW TO ORDER EXAMPLE

| Model No.   | Description | Example |
|-------------|-------------|---------|
| 294-4222EMT | Finish      | HVM     |

### VENEER (W) OPTIONS

Veneer tops feature UVAAdvantage, an ultra-violet finish, on all exposed surfaces by utilizing roll-coat UV technology.

|     |                    |     |                     |
|-----|--------------------|-----|---------------------|
| AW  | Artisan Walnut     | HW  | Harvest Walnut      |
| CO  | Columbian Walnut   | LW  | Legacy Walnut       |
| DC  | Dark Cherry        | MW  | Mahogany Walnut     |
| DFW | Dark Forest Walnut | SCH | Select Cherry       |
| EF  | Espresso           | SKC | Shaker Cherry       |
| GC  | Golden Cherry      | SM  | Sugar Maple         |
| HVM | Harvest Maple      | WC  | Williamsburg Cherry |

### TABLE EDGE PROFILE



Phoenix

### CERTIFICATIONS & COMPLIANCE

- Intertek Sustainability Certified
- BIFMA level® Certified
- BIFMA Compliant® Certified
- TSCA Title VI (CARB) Compliance
- US Green Building's LEED® Contribution

### STATEMENT OF LINE

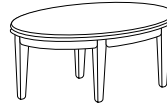

294-4222EMT:  
Elliptical  
Magazine Table  
[\(See Details\)](#)

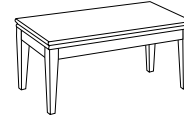

294-4222MT:  
Magazine Table  
[\(See Details\)](#)



294-2222LT:  
Lamp Table  
[\(See Details\)](#)



294-2622ET:  
End Table  
[\(See Details\)](#)



294-2222RET:  
Rounded End Table  
[\(See Details\)](#)

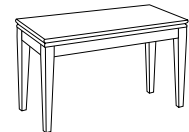

294-4216CT:  
Console Table  
[\(See Details\)](#)

| Item                      | Model No.   | W  | D  | H  | Ship Wt | Cubic Ft | List Price |
|---------------------------|-------------|----|----|----|---------|----------|------------|
| ELLIPTICAL MAGAZINE TABLE | 294-4222EMT | 42 | 22 | 16 | 48      | 14.4     | \$ 2808    |

**Description**

- Ships Assembled

Must Specify (in this order):

Model #  
Finish

|                |            |    |    |    |    |     |         |
|----------------|------------|----|----|----|----|-----|---------|
| MAGAZINE TABLE | 294-4222MT | 42 | 22 | 16 | 33 | 3.7 | \$ 1811 |
|----------------|------------|----|----|----|----|-----|---------|

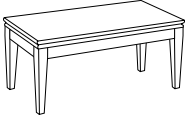
**Description**

- Ships KD; Some Assembly Required

Must Specify (in this order):

Model #  
Finish

|            |            |    |    |    |    |     |         |
|------------|------------|----|----|----|----|-----|---------|
| LAMP TABLE | 294-2222LT | 22 | 22 | 22 | 27 | 2.4 | \$ 1382 |
|------------|------------|----|----|----|----|-----|---------|

**Description**

- Ships KD; Some Assembly Required

Must Specify (in this order):

Model #  
Finish

|           |            |    |    |    |    |     |         |
|-----------|------------|----|----|----|----|-----|---------|
| END TABLE | 294-2622ET | 26 | 22 | 22 | 36 | 2.8 | \$ 1456 |
|-----------|------------|----|----|----|----|-----|---------|

**Description**

- Ships KD; Some Assembly Required

Must Specify (in this order):

Model #  
Finish

|                   |             |    |    |    |    |     |         |
|-------------------|-------------|----|----|----|----|-----|---------|
| ROUNDED END TABLE | 294-2222RET | 22 | 22 | 22 | 24 | 2.4 | \$ 1917 |
|-------------------|-------------|----|----|----|----|-----|---------|

**Description**

- Ships Assembled

Must Specify (in this order):

Model #  
Finish

|               |            |    |    |    |    |     |         |
|---------------|------------|----|----|----|----|-----|---------|
| CONSOLE TABLE | 294-4216CT | 42 | 16 | 30 | 36 | 3.9 | \$ 1726 |
|---------------|------------|----|----|----|----|-----|---------|

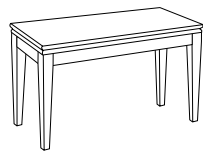
**Description**

- Ships KD; Some Assembly Required

Must Specify (in this order):

Model #  
Finish

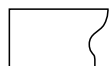

Phoenix

[See Intro Overview For Ordering Options](#)

A foundational suite of casegoods and tables primed to evolve with your needs. Gesso allows you to combine luxurious veneers, top grade laminates and other materials to create stylish, reconfigurable work spaces.

### CONSTRUCTION

- Exposed surfaces feature select grade plain sliced hardwood veneers in Cherry, Maple, American Black Walnut, White Oak, or composite veneers
- Veneer and standard high pressure laminate tops are 3-ply balanced construction and 1 $\frac{3}{8}$ " thick, with 3mm wood edge-banded rims contoured to the selected profile
- Grain direction runs left to right
- All units ship with heavy duty, adjustable leveling glides to ensure proper leveling and compensation for uneven floors
- Ships fully assembled

### HOW TO ORDER EXAMPLE

| Model No. | Description  | Example |
|-----------|--------------|---------|
| 65-2424ET | Top Material | W       |
|           | Finish       | LW      |
|           | Edge Profile | G       |

### VENEER (W) OPTIONS

Veneer tops feature UVAdvantage, an ultra-violet finish, on all exposed surfaces by utilizing roll-coat UV technology.

|     |                    |     |                     |
|-----|--------------------|-----|---------------------|
| AW  | Artisan Walnut     | MW  | Mahogany Walnut     |
| AS  | Asian Night        | MO  | Medium Oak*         |
| CO  | Columbian Walnut   | ORW | Oak Riftwood*       |
| DC  | Dark Cherry        | SCH | Select Cherry       |
| DFW | Dark Forest Walnut | SKC | Shaker Cherry       |
| EF  | Espresso           | SBP | Smoky Brown Pear    |
| FO  | Fawn Oak*          | SM  | Sugar Maple         |
| GC  | Golden Cherry      | SW  | Sunglow Walnut      |
| HVM | Harvest Maple      | WTA | Weathered Ash*      |
| HW  | Harvest Walnut     | WC  | Williamsburg Cherry |
| LW  | Legacy Walnut      |     |                     |

\* Finish is Low Sheen

### HPL (P) LAMINATE OPTIONS

#### WOODGRAIN

|     |                  |     |                     |
|-----|------------------|-----|---------------------|
| AS  | Asian Night      | PNW | Pinnacle Walnut     |
| BW  | Beigewood        | SCH | Select Cherry       |
| CO  | Columbian Walnut | SKC | Shaker Cherry       |
| EF  | Espresso         | SBP | Smoky Brown Pear    |
| GC  | Golden Cherry    | TK  | Studio Teak         |
| HVM | Harvest Maple    | SM  | Sugar Maple         |
| MW  | Mahogany Walnut  | WTA | Weathered Ash       |
| ORW | Oak Riftwood     | WC  | Williamsburg Cherry |

#### SOLID

|     |                |     |            |
|-----|----------------|-----|------------|
| BL  | Black          | PPD | Pepperdust |
| WH  | Designer White | SG  | Slate Grey |
| FHG | Fashion Grey   | WHS | White Sand |

### TABLE EDGE PROFILE

|   |             |
|---|-------------|
| F | Double Kerf |
| G | Duo         |
| X | Flute       |
| Y | Square      |

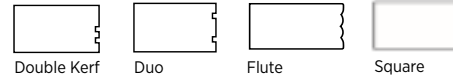

### CERTIFICATIONS & COMPLIANCE

- Intertek Sustainability Certified
- BIFMA level® Certified
- BIFMA Compliant® Certified
- TSCA Title VI (CARB) Compliance
- US Green Building's LEED® Contribution

### STATEMENT OF LINE

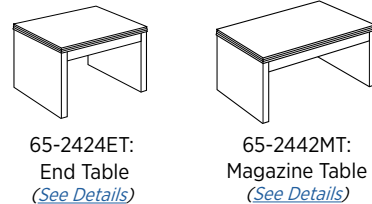

| Item      | Model No. | W  | D  | H  | Ship Wt | Cubic Ft | List Price |
|-----------|-----------|----|----|----|---------|----------|------------|
| END TABLE | 65-2424ET | 24 | 24 | 22 | 65      | 9.4      | W/P\$ 1531 |

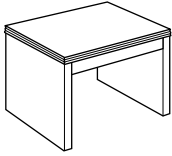

**Description**

- Standard with: Veneer Slab Ends and Apron Rail, with Adjustable Glides
- Choose from HPL (P) or Veneer (W) Top; Must Specify
- Ships Fully Assembled

Must Specify (in this order):

Model #  
Top Material  
Finish/Color  
Edge

|                |           |    |    |    |    |      |            |
|----------------|-----------|----|----|----|----|------|------------|
| MAGAZINE TABLE | 65-2442MT | 42 | 24 | 16 | 70 | 11.9 | W/P\$ 1612 |
|----------------|-----------|----|----|----|----|------|------------|

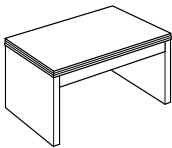

**Description**

- Standard with: Veneer Slab Ends and Apron Rail, with Adjustable Glides
- Choose from HPL (P) or Veneer (W) Top; Must Specify
- Ships Fully Assembled

Must Specify (in this order):

Model #  
Top Material  
Finish/Color  
Edge

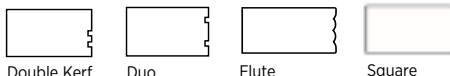

Double Kerf

Duo

Flute

Square

P = HPL W = Veneer

[See Intro Overview For Ordering Options](#)



Inspiration is designed to bring function and style to open area workspaces. Freestanding lamp and magazine tables complete waiting areas, welcoming lobbies, or office spaces. Pair Inspiration tables with the complementing guest, tandem, and bariatric seating to give guests a stylish and comfortable sitting area.

### CONSTRUCTION

- Exposed wood components are manufactured using European Beech and are free of spirits, discoloration, pits, shakes, and wormholes
- Constructed with 3-ply veneer tops, 1 $\frac{3}{16}$ " thick, featuring a self edge
- Joints are double-doweled or mortised and tenoned, screwed, and glued for maximum strength and durability
- Aprons are 3-ply veneer hardwood faces
- Frames are individually hand assembled and sanded prior to being finished
- Non-marring nylon glides included in each leg at floor level
- Some assembly required

### HOW TO ORDER EXAMPLE

| Model No. | Description | Example |
|-----------|-------------|---------|
| 48-2424LT | Finish      | TT      |

### WOOD FINISHES

Indiana Furniture uses a multi-step, hand finishing process on all exposed wood surfaces.

Tables feature a catalyzed varnish finish which offers durability, lasting beauty, and resistance to normal wear.

|                         |                        |
|-------------------------|------------------------|
| AW Artisan Walnut       | LW Legacy Walnut       |
| AS Asian Night          | MW Mahogany Walnut     |
| BW Beigewood*           | MO Medium Oak*         |
| BL Black                | ORW Oak Riftwood*      |
| CO Columbian Walnut     | PNW Pinnacle Walnut    |
| DC Dark Cherry          | SCH Select Cherry      |
| DFW Dark Forest Walnut* | SKC Shaker Cherry      |
| WH Designer White       | SBP Smoky Brown Pear*  |
| EF Espresso             | TK Studio Teak         |
| FO Fawn Oak*            | SM Sugar Maple         |
| GC Golden Cherry        | SW Sunglow Walnut      |
| HVM Harvest Maple*      | WTA Weathered Ash*     |
| HW Harvest Walnut       | WC Williamsburg Cherry |

\* Finish is Low Sheen

### CERTIFICATIONS & COMPLIANCE

- Intertek Sustainability Certified
- BIFMA level® Certified
- BIFMA Compliant Certified
- TSCA Title VI (CARB) Compliance
- US Green Building's LEED Contribution

### STATEMENT OF LINE

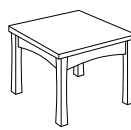

48-2424LT:  
Lamp Table  
([See Details](#))

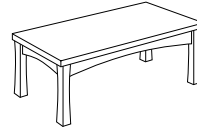

48-1836MT:  
Magazine Table  
([See Details](#))

| Item       | Model No. | W  | D  | H   | Ship Wt | Cubic Ft | List Price |
|------------|-----------|----|----|-----|---------|----------|------------|
| LAMP TABLE | 48-2424LT | 24 | 24 | 21¾ | 27      | 3.0      | \$ 1345    |

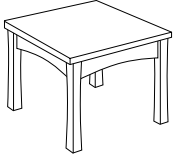
**Description**

- Ships KD; Some Assembly Required

Must Specify (in this order):

Model #  
Finish

|                |           |    |    |     |    |     |         |
|----------------|-----------|----|----|-----|----|-----|---------|
| MAGAZINE TABLE | 48-1836MT | 36 | 18 | 15¾ | 28 | 2.8 | \$ 1249 |
|----------------|-----------|----|----|-----|----|-----|---------|

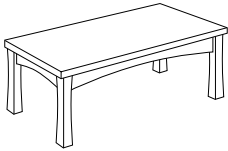
**Description**

- Ships KD; Some Assembly Required

Must Specify (in this order):

Model #  
Finish

[See Intro Overview For Ordering Options](#)

Open spaces really come together with Isla Lounge & Tables Collection. Create conversation settings or private areas by mixing components to fit the space and needs of the environment. Power and data options keep everyone working on-the-go.

### CONSTRUCTION

- External wood parts are kiln-dried hardwoods; internal parts are structurally engineered plywood; European Beech on legs
- Joints are double-doweled or mortised and tenoned, screwed, and glued for maximum strength and durability
- Tops are ¾" thick on occasional tables, 1" thick on Laminate tops, and 1 ⅜" on Veneer tops
- Solid Surface tops feature Straight (S1) edge profile
- Non-marring adjustable nylon guides included in each leg at floor level
- Ships fully assembled

### HOW TO ORDER EXAMPLES

|            |              |                    |
|------------|--------------|--------------------|
| 378-1626ET | Top Material | T                  |
|            | Finish       | AS                 |
|            | Upholstery   | Mayer Fedora Topaz |
|            | Leg          | WLEG, AS           |
|            | Power        | PWRUSBA            |

### TFL (T) LAMINATE TABLE TOP OPTIONS

#### WOODGRAIN

|     |                  |     |                     |
|-----|------------------|-----|---------------------|
| AS  | Asian Night      | PNW | Pinnacle Walnut     |
| BW  | Beigewood        | SCH | Select Cherry       |
| CO  | Columbian Walnut | SKC | Shaker Cherry       |
| EF  | Espresso         | SBP | Smoky Brown Pear    |
| GC  | Golden Cherry    | TK  | Studio Teak         |
| HVM | Harvest Maple    | SM  | Sugar Maple         |
| MW  | Mahogany Walnut  | WTA | Weathered Ash       |
| ORW | Oak Riftwood     | WC  | Williamsburg Cherry |

#### SOLID

|     |                |     |            |
|-----|----------------|-----|------------|
| BL  | Black          | PPD | Pepperdust |
| WH  | Designer White | SG  | Slate Grey |
| FHG | Fashion Grey   | WHS | White Sand |

### VENEER (W) TABLE TOP OPTIONS

Veneer tops feature UVAdvantage, an ultra-violet finish, on all exposed surfaces by utilizing roll-coat UV technology.

|     |                    |     |                     |
|-----|--------------------|-----|---------------------|
| AW  | Artisan Walnut     | MW  | Mahogany Walnut     |
| AS  | Asian Night        | MO  | Medium Oak*         |
| CO  | Columbian Walnut   | ORW | Oak Riftwood*       |
| DC  | Dark Cherry        | SCH | Select Cherry       |
| DFW | Dark Forest Walnut | SKC | Shaker Cherry       |
| EF  | Espresso           | SBP | Smoky Brown Pear    |
| FO  | Fawn Oak*          | SM  | Sugar Maple         |
| GC  | Golden Cherry      | SW  | Sunglow Walnut      |
| HVM | Harvest Maple      | WTA | Weathered Ash*      |
| HW  | Harvest Walnut     | WC  | Williamsburg Cherry |
| LW  | Legacy Walnut      |     |                     |

\* Finish is Low Sheen

### SOLID SURFACE (S) TABLE TOP OPTIONS

|    |              |     |              |
|----|--------------|-----|--------------|
| AR | Arroyo       | SNW | Snow White   |
| PE | Pebble Beach | SN  | Starry Night |
| SE | Sedona       | TN  | Tundra       |

### SOLID SURFACE EDGE PROFILE OPTIONS

S1 Straight



### LEG OPTIONS

|      |                                |             |
|------|--------------------------------|-------------|
| WLEG | Wood Leg, Specify Finish       | Std         |
| CLEG | Chrome Leg                     | \$ N/C      |
| PLEG | Powder Coat Leg, Specify Color | \$ 200      |
|      | ALUM Aluminum                  | NOIR Noir   |
|      | MIST Mist                      | OYST Oyster |
|      | SUGC Sugar Cookie              |             |

### LEG WOOD FINISHES

Indiana Furniture uses a multi-step, hand-finishing process on all exposed wood frames. Legs feature a catalyzed varnish finish offering durability, lasting beauty, and resistance to normal wear.

|     |                     |     |                     |
|-----|---------------------|-----|---------------------|
| AW  | Artisan Walnut      | LW  | Legacy Walnut       |
| AS  | Asian Night         | MW  | Mahogany Walnut     |
| BW  | Beigewood*          | MO  | Medium Oak*         |
| BL  | Black               | ORW | Oak Riftwood*       |
| CO  | Columbian Walnut    | PNW | Pinnacle Walnut     |
| DC  | Dark Cherry         | SCH | Select Cherry       |
| DFW | Dark Forest Walnut* | SKC | Shaker Cherry       |
| WH  | Designer White      | SBP | Smoky Brown Pear*   |
| EF  | Espresso            | TK  | Studio Teak         |
| FO  | Fawn Oak*           | SM  | Sugar Maple         |
| GC  | Golden Cherry       | SW  | Sunglow Walnut      |
| HVM | Harvest Maple*      | WTA | Weathered Ash*      |
| HW  | Harvest Walnut      | WC  | Williamsburg Cherry |

\* Finish is Low Sheen

### UPHOLSTERY OPTIONS

Available in single upholstery in a wide variety of graded-in or contract options, including fabric, vinyl, and leather.

### POWER OPTIONS

|         |                                   |        |
|---------|-----------------------------------|--------|
| PWRUSBA | Power and Two USB Ports, Aluminum | \$ 829 |
|---------|-----------------------------------|--------|

### CERTIFICATIONS & COMPLIANCE

- CAL 117-2013 Compliance
- Intertek Sustainability Certified
- BIFMA level® Certified
- BIFMA Compliant® Certified
- TSCA Title VI (CARB) Compliance
- US Green Building's LEED® Contribution

### STATEMENT OF LINE



378-1626ET: End Table ([See Details](#))



378-2226ET: Lamp Table ([See Details](#))

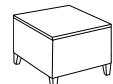

378-2626MT: Magazine Table ([See Details](#))

| Item             | Model No.  |               | W  | D   | H   | Ship Wt | Cubic Ft | List Price |
|------------------|------------|---------------|----|-----|-----|---------|----------|------------|
| <b>END TABLE</b> | 378-1626ET | TFL           | 16 | 26½ | 15½ | 42      | 11.0     | T\$ 899    |
|                  |            | Veneer        |    |     |     |         |          | W\$ 1001   |
|                  |            | Solid Surface |    |     |     |         |          | S\$ 1647   |



Must Specify (in this order):

- Model #
- Top Material
- Finish/Color
- Fabric
- Leg/Color
- Power

**Description**

- Standard with: Upholstered Chassis and Wood Legs
- Choose TFL (T), Veneer (W), or Solid Surface (S) Top
- Add Upholstery Grade Pricing to Top Material Price
- Optional Leg and Power

| Add List Price/Grade | Yards | COM/1 | 2  | 3  | 4   | 5   | 6   | 7   | 8   | 9   | 10  | L1  | L2  |
|----------------------|-------|-------|----|----|-----|-----|-----|-----|-----|-----|-----|-----|-----|
| Single Upholstery    | 1.00  | \$ 0  | 49 | 90 | 130 | 191 | 253 | 342 | 433 | 541 | 664 | 310 | 442 |

|                   |            |               |    |     |     |    |      |          |
|-------------------|------------|---------------|----|-----|-----|----|------|----------|
| <b>LAMP TABLE</b> | 378-2226ET | TFL           | 22 | 26½ | 15½ | 48 | 12.0 | T\$ 943  |
|                   |            | Veneer        |    |     |     |    |      | W\$ 1158 |
|                   |            | Solid Surface |    |     |     |    |      | S\$ 1950 |

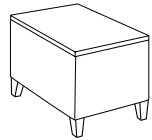

Must Specify (in this order):

- Model #
- Top Material
- Finish/Color
- Fabric
- Leg/Color
- Power

**Description**

- Standard with: Upholstered Chassis and Wood Legs
- Choose TFL (T), Veneer (W), or Solid Surface (S) Top
- Add Upholstery Grade Pricing to Top Material Price
- Optional Leg and Power

| Add List Price/Grade | Yards | COM/1 | 2  | 3  | 4   | 5   | 6   | 7   | 8   | 9   | 10  | L1  | L2  |
|----------------------|-------|-------|----|----|-----|-----|-----|-----|-----|-----|-----|-----|-----|
| Single Upholstery    | 1.00  | \$ 0  | 49 | 90 | 130 | 191 | 253 | 342 | 433 | 541 | 664 | 310 | 442 |

|                       |            |               |     |     |     |    |      |          |
|-----------------------|------------|---------------|-----|-----|-----|----|------|----------|
| <b>MAGAZINE TABLE</b> | 378-2626MT | TFL           | 26½ | 26½ | 15½ | 57 | 15.0 | T\$ 998  |
|                       |            | Veneer        |     |     |     |    |      | W\$ 1227 |
|                       |            | Solid Surface |     |     |     |    |      | S\$ 2217 |

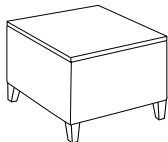

Must Specify (in this order):

- Model #
- Top Material
- Finish/Color
- Fabric
- Leg/Color
- Power

**Description**

- Standard with: Upholstered Chassis and Ganging Hardware
- Choose TFL (T), Veneer (W), or Solid Surface (S) Top
- Add Upholstery Grade Pricing to Top Material Price
- Optional Leg and Power

| Add List Price/Grade | Yards | COM/1 | 2  | 3  | 4   | 5   | 6   | 7   | 8   | 9   | 10  | L1  | L2  |
|----------------------|-------|-------|----|----|-----|-----|-----|-----|-----|-----|-----|-----|-----|
| Single Upholstery    | 1.00  | \$ 0  | 49 | 90 | 130 | 191 | 253 | 342 | 433 | 541 | 664 | 310 | 442 |

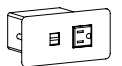

1 Electrical Power and 2 USB Outlets

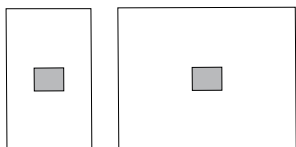

Power is centered into End, Lamp, and Magazine Tables, as shown above

T = TFL W = Veneer S = Solid Surface

[See Intro Overview For Ordering Options](#)

Jefferson echoes history and creates a timeless foundation for today's sophisticated work place. Finely crafted in select solids with walnut veneers, the tailored details of this collection accentuate our expert craftsmanship and perfect attention to detail.

**CONSTRUCTION**

- Veneers on exposed surfaces are select grade sliced American Black Walnut and Cherry are carefully selected and matched to assure proper balance and consistency
- Veneer and HPL tops featuring the C2 tops are 5-ply balanced construction, 1 $\frac{3}{16}$ " thick, with solid hardwood mitered rims
- Grain direction runs left to right
- All units ship with heavy duty, adjustable leveling glides to ensure proper leveling and compensation for uneven floors
- Ships KD; some assembly required

**HOW TO ORDER EXAMPLE**

| Model No. | Description  | Example |
|-----------|--------------|---------|
| 46-1824ET | Top Material | W       |
|           | Finish       | LW      |

**PREMIUM AND STANDARD VENEER (W) OPTIONS**

Tops feature UVAdvantage, an ultra-violet finish, on all exposed surfaces by utilizing roll-coat UV technology.

|     |                    |     |                     |
|-----|--------------------|-----|---------------------|
| AW  | Artisan Walnut     | HW  | Harvest Walnut      |
| CO  | Columbian Walnut   | LW  | Legacy Walnut       |
| DC  | Dark Cherry        | MW  | Mahogany Walnut     |
| DFW | Dark Forest Walnut | SCH | Select Cherry       |
| EW  | Espresso           | SKC | Shaker Cherry       |
| GC  | Golden Cherry      | WC  | Williamsburg Cherry |

**HPL (P) TOP OPTIONS**

| WOODGRAIN |                  |     |                     |
|-----------|------------------|-----|---------------------|
| CO        | Columbian Walnut | SCH | Select Cherry       |
| EF        | Espresso         | SKC | Shaker Cherry       |
| GC        | Golden Cherry    | WC  | Williamsburg Cherry |
| MW        | Mahogany Walnut  |     |                     |

**TABLE EDGE PROFILE**



C2

**CERTIFICATIONS & COMPLIANCE**

- Intertek Sustainability Certified
- BIFMA level® Certified
- BIFMA Compliant® Certified
- TSCA Title VI (CARB) Compliance
- US Green Building's LEED® Contribution

**STATEMENT OF LINE**

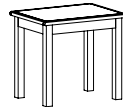

46-1824ET:  
End Table  
[\(See Details\)](#)

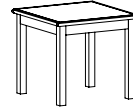

46-2424LT:  
Lamp Table  
[\(See Details\)](#)



46-1847MT:  
Magazine Table  
[\(See Details\)](#)

| Item      | Model No. | W  | D  | H                                | Ship Wt | Cubic Ft | List Price |      |
|-----------|-----------|----|----|----------------------------------|---------|----------|------------|------|
| END TABLE | 46-1824ET | 24 | 18 | 21 <sup>13</sup> / <sub>16</sub> | 25      | 2.0      | W/P\$      | 1273 |
|           |           |    |    |                                  |         |          | PV\$       | 1427 |

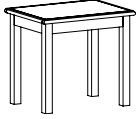

### Description

- Available with Premium/Standard Veneer (PV/W) or HPL (P) Top; Must Specify
- Hardwood Legs
- Shipped KD; Some Assembly Required

Must Specify (in this order):

Model #  
Top Material  
Finish/Color

| Item       | Model No. | W  | D  | H                                | Ship Wt | Cubic Ft | List Price |      |
|------------|-----------|----|----|----------------------------------|---------|----------|------------|------|
| LAMP TABLE | 46-2424LT | 24 | 24 | 21 <sup>13</sup> / <sub>16</sub> | 37      | 3.3      | W/P\$      | 1621 |
|            |           |    |    |                                  |         |          | PV\$       | 1816 |

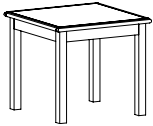

### Description

- Available with Premium/Standard Veneer (PV/W) or HPL (P) Top; Must Specify
- Hardwood Legs
- Shipped KD; Some Assembly Required

Must Specify (in this order):

Model #  
Top Material  
Finish/Color

| Item           | Model No. | W  | D  | H  | Ship Wt | Cubic Ft | List Price |      |
|----------------|-----------|----|----|----|---------|----------|------------|------|
| MAGAZINE TABLE | 46-1847MT | 47 | 18 | 16 | 42      | 3.4      | W/P\$      | 1531 |
|                |           |    |    |    |         |          | PV\$       | 1715 |

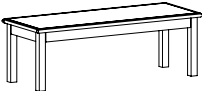

### Description

- Available with Premium/Standard Veneer (PV/W) or HPL (P) Top; Must Specify
- Hardwood Legs
- Optional 30"H Legs
- Shipped KD; Some Assembly Required

Must Specify (in this order):

Model #  
Top Material  
Finish/Color  
Optional 30"H Leg

### Options: Specify & Add

|       |                    |    |     |
|-------|--------------------|----|-----|
| SH-46 | Optional 30"H Legs | \$ | 209 |
|-------|--------------------|----|-----|



C2

P = HPL W = Veneer

[See Intro Overview For Ordering Options](#)

Discover the perfect table collection that goes anywhere. With a mix of materials, Jot complements a diverse range of interiors from ultra modern to classic. Its metal base, available in five refreshed colors, supports tops in solid surface, veneer, or laminate. Scaled for a perfect fit, Jot makes a great first impression front and center or corner-tucked for convenient storage. Jot's UV Advantage finish features a crystal clear topcoat developed for durability in high traffic areas.

### CONSTRUCTION

- Veneer tops are ¾" thick with veneer edge bands; made of select grade, sliced Black Walnut, Cherry, Maple, or Composite species
- TFL tops are ¾" thick with a 1mm PVC edge band
- Solid surface tops are ¾" thick and are available in six colors and two edge profiles
- Bases are manufactured using ¾" steel frames and powder coated in your choice of five standard colors
- Joints on bases are mitered and fully welded for maximum strength and durability
- Tops are securely fastened to the bases with metal screws
- Ships fully assembled

### HOW TO ORDER EXAMPLES

|            |                                |      |
|------------|--------------------------------|------|
| 410-1412AT | Top Material                   | T    |
|            | Finish                         | TK   |
|            | Edge Detail<br>(if applicable) | -    |
|            | Metal Base Color               | ALUM |

### TFL (T) LAMINATE TABLE TOP OPTIONS

#### WOODGRAIN

|     |                  |     |                     |
|-----|------------------|-----|---------------------|
| AS  | Asian Night      | PNW | Pinnacle Walnut     |
| BW  | Beigewood        | SCH | Select Cherry       |
| CO  | Columbian Walnut | SKC | Shaker Cherry       |
| EF  | Espresso         | SBP | Smoky Brown Pear    |
| GC  | Golden Cherry    | TK  | Studio Teak         |
| HVM | Harvest Maple    | SM  | Sugar Maple         |
| MW  | Mahogany Walnut  | WTA | Weathered Ash       |
| ORW | Oak Riftwood     | WC  | Williamsburg Cherry |

#### SOLID

|     |                |     |            |
|-----|----------------|-----|------------|
| BL  | Black          | PPD | Pepperdust |
| WH  | Designer White | SG  | Slate Grey |
| FHG | Fashion Grey   | WHS | White Sand |

### VEENER (W) TABLE TOP OPTIONS

Tops feature UVAdvantage, an ultra-violet finish, on all exposed surfaces by utilizing roll-coat UV technology.

|     |                    |     |                     |
|-----|--------------------|-----|---------------------|
| AW  | Artisan Walnut     | MW  | Mahogany Walnut     |
| AS  | Asian Night        | MO  | Medium Oak*         |
| CO  | Columbian Walnut   | ORW | Oak Riftwood*       |
| DC  | Dark Cherry        | SCH | Select Cherry       |
| DFW | Dark Forest Walnut | SKC | Shaker Cherry       |
| EF  | Espresso           | SBP | Smoky Brown Pear    |
| FO  | Fawn Oak*          | SM  | Sugar Maple         |
| GC  | Golden Cherry      | SW  | Sunglow Walnut      |
| HVM | Harvest Maple      | WTA | Weathered Ash*      |
| HW  | Harvest Walnut     | WC  | Williamsburg Cherry |
| LW  | Legacy Walnut      |     |                     |

\* Finish is Low Sheen

### SOLID SURFACE (S) TABLE TOP OPTIONS

|    |              |     |              |
|----|--------------|-----|--------------|
| AR | Arroyo       | SNW | Snow White   |
| PE | Pebble Beach | SN  | Starry Night |
| SE | Sedona       | TN  | Tundra       |

### SOLID SURFACE EDGE PROFILE OPTIONS

|    |          |
|----|----------|
| S1 | Straight |
| S2 | Roman    |



### METAL BASE OPTIONS

|      |              |
|------|--------------|
| ALUM | Aluminum     |
| MIST | Mist         |
| NOIR | Noir         |
| OYST | Oyster       |
| SUGC | Sugar Cookie |

### CERTIFICATIONS & COMPLIANCE

- Intertek Sustainability Certified
- BIFMA level® Certified
- BIFMA Compliant® Certified
- TSCA Title VI (CARB) Compliance
- US Green Building's LEED® Contribution

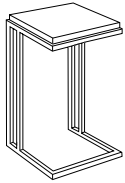

410-1412AT:  
Auxiliary Table  
[\(See Details\)](#)

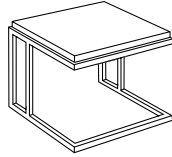

Square End Tables  
410-1818ET: 18"  
410-2424ET: 24"  
[\(See Details\)](#)

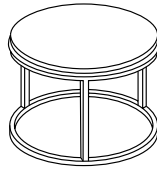

410-2020CT:  
Circular End Table  
[\(See Details\)](#)

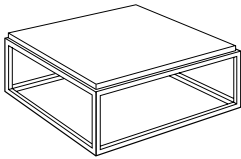

410-3636SQ:  
Square Cocktail  
Table  
[\(See Details\)](#)

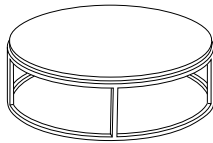

410-3636CT:  
Circular Cocktail  
Table  
[\(See Details\)](#)

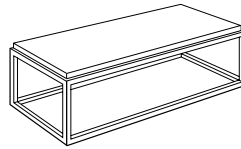

410-2248MT:  
Rectangular Cocktail  
Table  
[\(See Details\)](#)

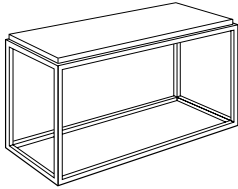

410-1848ST:  
Console Table  
[\(See Details\)](#)



| Item            | Model No.  |               | W   | D  | H   | Ship Wt | Cubic Ft | List Price |
|-----------------|------------|---------------|-----|----|-----|---------|----------|------------|
| AUXILIARY TABLE | 410-1412AT | TFL           | 12½ | 14 | 26½ | 46      | 8.6      | T\$ 1218   |
|                 |            | Veneer        |     |    |     |         |          | W\$ 1369   |
|                 |            | Solid Surface |     |    |     |         |          | S\$ 2222   |

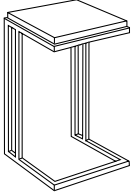

Must Specify (in this order):

Model #  
Top Material  
Finish/Color  
Edge Profile (if applicable)  
Base Color

**Description**

- Standard with: Decorative Metal Base and Nylon Glides
- Select Your Choice of TFL (T), Veneer (W), or Solid Surface (S) Top
- [See Top Options, Base Color Options and Specify](#)

|                  |            |               |    |    |    |    |     |          |
|------------------|------------|---------------|----|----|----|----|-----|----------|
| SQUARE END TABLE | 410-2424ET | TFL           | 24 | 24 | 20 | 46 | 8.6 | T\$ 1202 |
|                  |            | Veneer        |    |    |    |    |     | W\$ 1468 |
|                  |            | Solid Surface |    |    |    |    |     | S\$ 2599 |
|                  | 410-1818ET | TFL           | 18 | 18 | 20 | 34 | 5.1 | T\$ 1122 |
|                  |            | Veneer        |    |    |    |    |     | W\$ 1323 |
|                  |            | Solid Surface |    |    |    |    |     | S\$ 2161 |

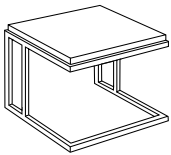

Must Specify (in this order):

Model #  
Top Material  
Finish/Color  
Edge Profile (if applicable)  
Base Color

**Description**

- Standard with: Decorative Metal Base and Nylon Glides
- Select Your Choice of TFL (T), Veneer (W), or Solid Surface (S) Top
- [See Top Options, Base Color Options and Specify](#)

|                    |            |               |    |    |    |    |     |          |
|--------------------|------------|---------------|----|----|----|----|-----|----------|
| CIRCULAR END TABLE | 410-2020CT | TFL           | 20 | 20 | 20 | 36 | 6.2 | T\$ 1090 |
|                    |            | Veneer        |    |    |    |    |     | W\$ 1392 |
|                    |            | Solid Surface |    |    |    |    |     | S\$ 4061 |

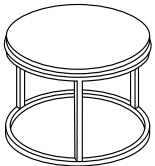

Must Specify (in this order):

Model #  
Top Material  
Finish/Color  
Edge Profile (if applicable)  
Base Color

**Description**

- Standard with: Decorative Metal Base and Adjustable Levelers
- Select Your Choice of TFL (T), Veneer (W), or Solid Surface (S) Top
- [See Top Options, Base Color Options and Specify](#)

|                       |            |               |    |    |    |    |      |          |
|-----------------------|------------|---------------|----|----|----|----|------|----------|
| SQUARE COCKTAIL TABLE | 410-3636SQ | TFL           | 36 | 36 | 15 | 68 | 13.4 | T\$ 1440 |
|                       |            | Veneer        |    |    |    |    |      | W\$ 1742 |
|                       |            | Solid Surface |    |    |    |    |      | S\$ 4310 |

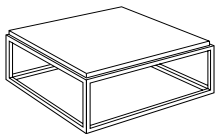

Must Specify (in this order):

Model #  
Top Material  
Finish/Color  
Edge Profile (if applicable)  
Base Color

**Description**

- Standard with: Decorative Metal Base and Nylon Glides
- Select Your Choice of TFL (T), Veneer (W), or Solid Surface (S) Top
- [See Top Options, Base Color Options and Specify](#)

T = TFL W = Veneer S = Solid Surface

[See Intro Overview For Ordering Options](#)

| Item                       | Model No.  |               | W  | D  | H  | Ship Wt | Cubic Ft | List Price |
|----------------------------|------------|---------------|----|----|----|---------|----------|------------|
| RECTANGULAR COCKTAIL TABLE | 410-2248MT | TFL           | 48 | 22 | 15 | 92      | 11.0     | T\$ 1372   |
|                            |            | Veneer        |    |    |    |         |          | W\$ 1623   |
|                            |            | Solid Surface |    |    |    |         |          | S\$ 3526   |

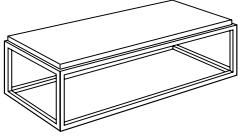

Must Specify (in this order):

Model #  
Top Material  
Finish/Color  
Edge Profile (if applicable)  
Base Color

#### Description

- Standard with: Decorative Metal Base and Nylon Glides
- Select Your Choice of TFL (T), Veneer (W), or Solid Surface (S) Top
- [See Top Options, Base Color Options and Specify](#)

|                         |            |               |    |    |    |    |      |          |
|-------------------------|------------|---------------|----|----|----|----|------|----------|
| CIRCULAR COCKTAIL TABLE | 410-3636CT | TFL           | 36 | 36 | 15 | 68 | 13.4 | T\$ 1361 |
|                         |            | Veneer        |    |    |    |    |      | W\$ 1730 |
|                         |            | Solid Surface |    |    |    |    |      | S\$ 6207 |

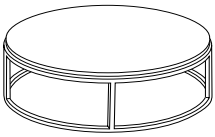

Must Specify (in this order):

Model #  
Top Material  
Finish/Color  
Edge Profile (if applicable)  
Base Color

#### Description

- Standard with: Decorative Metal Base and Adjustable Levelers
- Select Your Choice of TFL (T), Veneer (W), or Solid Surface (S) Top
- [See Top Options, Base Color Options and Specify](#)

|               |            |               |    |    |    |    |      |          |
|---------------|------------|---------------|----|----|----|----|------|----------|
| CONSOLE TABLE | 410-1848ST | TFL           | 48 | 18 | 28 | 86 | 17.4 | T\$ 1476 |
|               |            | Veneer        |    |    |    |    |      | W\$ 1755 |
|               |            | Solid Surface |    |    |    |    |      | S\$ 3342 |

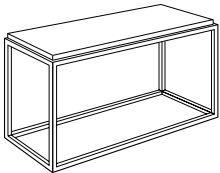

Must Specify (in this order):

Model #  
Top Material  
Finish/Color  
Edge Profile (if applicable)  
Base Color

#### Description

- Standard with: Decorative Metal Base and Adjustable Levelers
- Select Your Choice of TFL (T), Veneer (W), or Solid Surface (S) Top
- [See Top Options, Base Color Options and Specify](#)

T = TFL W = Veneer S = Solid Surface

[See Intro Overview For Ordering Options](#)

Create a variety of looks from refined transitional to clean contemporary with an abundance of finishes and edge details. Madera features ultra violet finish for long lasting beauty in corporate environments, as well as a premium veneer option, which offers a grade of veneer exceeding the general commercial market standards.

### CONSTRUCTION

- Choose from premium veneer or select veneer on exposed surfaces in American Black Walnut, White Oak, Cherry, or Maple species
- Veneer tops are available in the 6 edge profiles and have a 5-ply balanced construction, 1 $\frac{3}{16}$ " thick, with hardwood rims
- High pressure laminate (HPL) tops have a 3-ply balanced construction, 1 $\frac{3}{16}$ " thick, with solid hardwood rims
- Grain direction runs left to right
- All units ship with heavy duty, adjustable leveling glides to ensure proper leveling and compensation for uneven floors
- Ships fully assembled

### HOW TO ORDER EXAMPLE

| Model No. | Description  | Example |
|-----------|--------------|---------|
| 14-1824ET | Top Material | W       |
|           | Finish       | AW      |
|           | Edge Profile | X       |

### VENEER (W) AND PREMIUM VENEER (PV) OPTIONS

Veneer tops feature UVAdvantage, an ultra-violet finish, on all exposed surfaces by utilizing roll-coat UV technology.

|     |                    |     |                     |
|-----|--------------------|-----|---------------------|
| AW  | Artisan Walnut     | HW  | Harvest Walnut      |
| CO  | Columbian Walnut   | LW  | Legacy Walnut       |
| DC  | Dark Cherry        | MW  | Mahogany Walnut     |
| DFW | Dark Forest Walnut | MO  | Medium Oak*         |
| EF  | Espresso           | SCH | Select Cherry       |
| FO  | Fawn Oak*          | SKC | Shaker Cherry       |
| GC  | Golden Cherry      | SM  | Sugar Maple         |
| HVM | Harvest Maple      | WC  | Williamsburg Cherry |

\* Finish is Low Sheen

### HPL (P) LAMINATE OPTIONS

|     |                  |     |                     |
|-----|------------------|-----|---------------------|
| CO  | Columbian Walnut | SCH | Select Cherry       |
| EF  | Espresso         | SKC | Shaker Cherry       |
| GC  | Golden Cherry    | SM  | Sugar Maple         |
| HVM | Harvest Maple    | WC  | Williamsburg Cherry |
| MW  | Mahogany Walnut  |     |                     |

### TABLE EDGE PROFILE

|   |           |
|---|-----------|
| B | Bevel     |
| D | Bullnose  |
| X | Flute     |
| A | Radius    |
| Y | Square    |
| E | Tri-Round |



Bevel



Bullnose

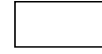

Flute



Radius



Square

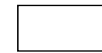

Tri-Round

### CERTIFICATIONS & COMPLIANCE

- Intertek Sustainability Certified
- BIFMA level® Certified
- BIFMA Compliant® Certified
- TSCA Title VI (CARB) Compliance
- US Green Building's LEED® Contribution

### STATEMENT OF LINE

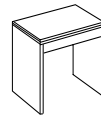

14-1824ET:  
End Table  
[\(See Details\)](#)

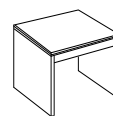

14-2828LT:  
Lamp Table  
[\(See Details\)](#)

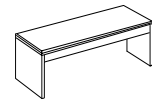

14-1847MT:  
Magazine Table  
[\(See Details\)](#)

| Item             | Model No. |                | W  | D  | H                 | Ship Wt | Cubic Ft | List Price |      |
|------------------|-----------|----------------|----|----|-------------------|---------|----------|------------|------|
| <b>END TABLE</b> | 14-1824ET | Veneer or HPL  | 24 | 18 | 21 $\frac{1}{16}$ | 48      | 7.6      | W/P\$      | 1281 |
|                  |           | Premium Veneer |    |    |                   |         |          | PV\$       | 1500 |

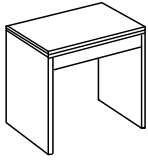

**Description**

- Standard with: Left to Right Grain Direction on Worksurface, Vertical Grain Direction on Solid End Panels
- Available in Premium Veneer (PV) or Standard Veneer (W); Must Specify
- Available with Veneer (PV/W) or HPL (P) Top; Must Specify
- Ships Assembled

Must Specify (in this order):

- Model
- Premium or Standard Veneer
- Chassis
- Top Material
- Finish/Color
- Edge Profile

|                   |           |                |    |    |                   |    |      |       |      |
|-------------------|-----------|----------------|----|----|-------------------|----|------|-------|------|
| <b>LAMP TABLE</b> | 14-2828LT | Veneer or HPL  | 28 | 28 | 21 $\frac{1}{16}$ | 56 | 12.3 | W/P\$ | 1658 |
|                   |           | Premium Veneer |    |    |                   |    |      | PV\$  | 1944 |

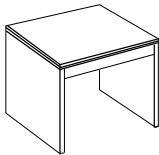

**Description**

- Standard with: Left to Right Grain Direction on Worksurface, Vertical Grain Direction on Solid End Panels
- Available in Premium Veneer (PV) or Standard Veneer (W); Must Specify
- Available with Veneer (PV/W) or HPL (P) Top; Must Specify
- Ships Assembled

Must Specify (in this order):

- Model
- Premium or Standard Veneer
- Chassis
- Top Material
- Finish/Color
- Edge Profile

|                       |           |                |    |    |                   |    |     |       |      |
|-----------------------|-----------|----------------|----|----|-------------------|----|-----|-------|------|
| <b>MAGAZINE TABLE</b> | 14-1847MT | Veneer or HPL  | 47 | 18 | 15 $\frac{1}{16}$ | 75 | 9.9 | W/P\$ | 1400 |
|                       |           | Premium Veneer |    |    |                   |    |     | PV\$  | 1639 |

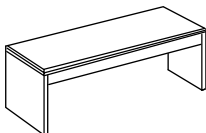

**Description**

- Standard with: Left to Right Grain Direction on Worksurface, Vertical Grain Direction on Solid End Panels
- Available in Premium Veneer (PV) or Standard Veneer (W); Must Specify
- Available with Veneer (PV/W) or HPL (P) Top; Must Specify
- Ships Assembled

Must Specify (in this order):

- Model #
- Top Material
- Finish/Color
- Edge Profile

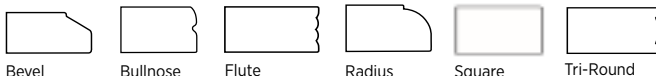

Bevel    Bullnose    Flute    Radius    Square    Tri-Round

P = HPL    W = Veneer    PV = Premium Veneer

See Intro Overview For Ordering Options

In partnership with Edge Design, a UK-based company, we welcome Me, Myself & I.

With the growth of open and breakout areas in the working environments, Me, Myself & I provides a relaxed and collective seating and tables solution.

### CONSTRUCTION

- Exposed parts are manufactured using European Beech
- Joints are double-doweled or mortised and tenoned, screwed, and glued for maximum strength and durability
- Frames are individually hand assembled and sanded prior to being finished; Legs are 9¾"H on the rectangular table and 14"H on the square table
- Non-marring nylon glides included in each leg at floor level
- Tables have 1½" thick HPL surface with 1mm PVC edge band
- Ships fully assembled

### HOW TO ORDER EXAMPLE

| Model No. | Description | Example |
|-----------|-------------|---------|
| MMIT-2    | Leg Finish  | BW      |
|           | Top Color   | WH      |

### HPL (P) LAMINATE OPTIONS ON TABLES TOPS

#### WOODGRAIN

|     |                  |     |                     |
|-----|------------------|-----|---------------------|
| AS  | Asian Night      | PNW | Pinnacle Walnut     |
| BW  | Beigewood        | SCH | Select Cherry       |
| CO  | Columbian Walnut | SKC | Shaker Cherry       |
| EF  | Espresso         | SBP | Smoky Brown Pear    |
| GC  | Golden Cherry    | TK  | Studio Teak         |
| HVM | Harvest Maple    | SM  | Sugar Maple         |
| MW  | Mahogany Walnut  | WTA | Weathered Ash       |
| ORW | Oak Riftwood     | WC  | Williamsburg Cherry |

#### SOLID

|    |                |
|----|----------------|
| WH | Designer White |
|----|----------------|

### WOOD FINISHES AVAILABLE ON LEGS

|     |                     |     |                     |
|-----|---------------------|-----|---------------------|
| AW  | Artisan Walnut      | LW  | Legacy Walnut       |
| AS  | Asian Night         | MW  | Mahogany Walnut     |
| BW  | Beigewood*          | MO  | Medium Oak*         |
| BL  | Black               | ORW | Oak Riftwood*       |
| CO  | Columbian Walnut    | PNW | Pinnacle Walnut     |
| DC  | Dark Cherry         | SCH | Select Cherry       |
| DFW | Dark Forest Walnut* | SKC | Shaker Cherry       |
| WH  | Designer White      | SBP | Smoky Brown Pear*   |
| EF  | Espresso            | TK  | Studio Teak         |
| FO  | Fawn Oak*           | SM  | Sugar Maple         |
| GC  | Golden Cherry       | SW  | Sunglow Walnut      |
| HVM | Harvest Maple*      | WTA | Weathered Ash*      |
| HW  | Harvest Walnut      | WC  | Williamsburg Cherry |

\* Finish is Low Sheen

### TABLE EDGE PROFILE



Square

### CERTIFICATIONS & COMPLIANCE

- Intertek Sustainability Certified
- BIFMA level® Certified
- BIFMA Compliant Certified
- TSCA Title VI (CARB) Compliance
- US Green Building's LEED Contribution

### STATEMENT OF LINE

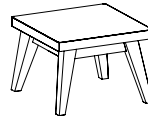

MMIT-1:  
Square Table  
[\(See Details\)](#)

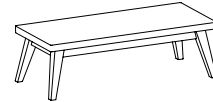

MMIT-2:  
Rectangle Table  
[\(See Details\)](#)

| Item         | Model No. | W  | D  | H  | Ship Wt | Cubic Ft | List Price |
|--------------|-----------|----|----|----|---------|----------|------------|
| SQUARE TABLE | MMIT-1    | 22 | 22 | 16 | 31      | 10.8     | \$ 950     |

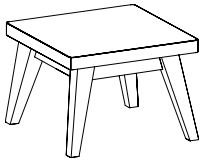

### Description

- Features Square Edge Profile
- Available with Contrasting Top and Leg Color

Must Specify (in this order):

Model #  
Leg Finish  
Top Color

|                 |        |    |    |    |    |      |         |
|-----------------|--------|----|----|----|----|------|---------|
| RECTANGLE TABLE | MMIT-2 | 51 | 22 | 16 | 66 | 25.9 | \$ 1295 |
|-----------------|--------|----|----|----|----|------|---------|

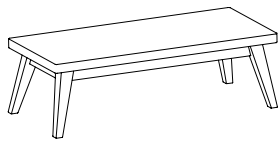

### Description

- Features Square Edge Profile
- Available in Contrasting Surface and Leg Color

Must Specify (in this order):

Model #  
Leg Finish  
Top Color



Square

[See Intro Overview For Ordering Options](#)

Crafted in American veneers, Phoenix's clean, transitional styling is at ease in both contemporary and traditional settings. It is a perfect choice for value-minded companies who want a sophisticated, yet uncomplicated, solution.

### CONSTRUCTION

- Veneers on exposed surfaces are select grade sliced American Black Walnut and Cherry, and are carefully selected and matched to assure proper balance and consistency
- Veneer tops are 5-ply balanced construction and 1½" thick. High pressure laminate (HPL) tops are 3-ply balanced construction and 1½" thick
- Grain direction runs left to right
- All units ship with heavy duty, adjustable leveling glides to ensure proper leveling and compensation for uneven floors
- Some assembly required

### HOW TO ORDER EXAMPLE

| Model No. | Description  | Example |
|-----------|--------------|---------|
| 21-1847MT | Top Material | P       |
|           | Finish       | SKC     |

### VENEER (W) OPTIONS

Veneer features UVAdvantage, an ultra-violet finish, on all exposed surfaces by utilizing roll-coat UV technology. Apron rails and legs features multi-step, hand-finished catalyzed finish.

|     |                    |     |                     |
|-----|--------------------|-----|---------------------|
| AW  | Artisan Walnut     | HW  | Harvest Walnut      |
| CO  | Columbian Walnut   | LW  | Legacy Walnut       |
| DC  | Dark Cherry        | MW  | Mahogany Walnut     |
| DFW | Dark Forest Walnut | SCH | Select Cherry       |
| EW  | Espresso           | SKC | Shaker Cherry       |
| GC  | Golden Cherry      | WC  | Williamsburg Cherry |

### HPL (P) TOP OPTIONS

|    |                  |     |                     |
|----|------------------|-----|---------------------|
| CO | Columbian Walnut | SCH | Select Cherry       |
| EF | Espresso         | SKC | Shaker Cherry       |
| GC | Golden Cherry    | WC  | Williamsburg Cherry |
| MW | Mahogany Walnut  |     |                     |

### TABLE EDGE PROFILE



Phoenix

### CERTIFICATIONS & COMPLIANCE

- Intertek Sustainability Certified
- BIFMA level® Certified
- BIFMA Compliant® Certified
- TSCA Title VI (CARB) Compliance
- US Green Building's LEED® Contribution

### STATEMENT OF LINE

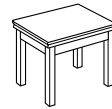

21-1824ET:  
End Table  
[\(See Details\)](#)

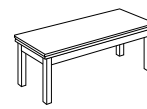

21-1847MT:  
Magazine Table  
[\(See Details\)](#)

| Item      | Model No. |               | W  | D  | H  | Ship Wt | Cubic Ft | List Price         |  |
|-----------|-----------|---------------|----|----|----|---------|----------|--------------------|--|
| END TABLE | 21-1824ET | HPL<br>Veneer | 18 | 24 | 22 | 25      | 2.0      | P\$ 871<br>W\$ 919 |  |

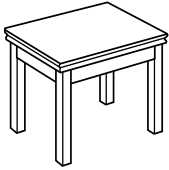

**Description**

- Available with Veneer (W) or HPL (P) Top, Must Specify
- Shipped KD; Some Assembly Required

Must Specify (in this order):

- Model #
- Top Material
- Finish/Color

|                |           |               |    |    |    |    |     |                     |  |
|----------------|-----------|---------------|----|----|----|----|-----|---------------------|--|
| MAGAZINE TABLE | 21-1847MT | HPL<br>Veneer | 47 | 18 | 16 | 42 | 3.4 | P\$ 1135<br>W\$ 919 |  |
|----------------|-----------|---------------|----|----|----|----|-----|---------------------|--|

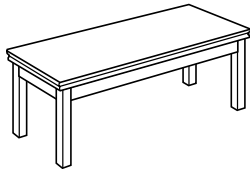

**Description**

- Available with Veneer (W) or HPL (P) Top, Must Specify
- Shipped KD; Some Assembly Required
- Optional 30" Leg; See Below

**Leg Option: Specify & Add**

|         |           |  |  |  |  |    |     |        |  |
|---------|-----------|--|--|--|--|----|-----|--------|--|
| 30H-2SQ | 30"H Legs |  |  |  |  | 20 | 0.9 | \$ 209 |  |
|---------|-----------|--|--|--|--|----|-----|--------|--|

Must Specify (in this order):

- Model #
- Top Material
- Finish/Color
- Leg



Phoenix

P = HPL W = Veneer

[See Intro Overview For Ordering Options](#)



Plush Lounge seamlessly brings together the endurance needed for commercial spaces with the relaxed comforts of home. Introducing a smart range of freestanding and modular seating components, along with coordinating tables, that provide the flexibility and comfort needed in today's ever-changing environments.

### CONSTRUCTION

- Exposed wood parts are kiln-dried hardwoods, selected from the highest grades of plain sliced hardwood veneers and are free of spirits, discoloration, pits, shakes, and wormholes
- Joints are mortised and tenoned, screwed, and glued for maximum strength and durability
- Maple Wood Legs are 2"Wx2½Dx6"H; Metal Legs are 2"Wx2"Dx6"H
- Non-marring adjustable nylon glides included at floor level
- Table tops are ¾" thick and feature a vertical square profiled edge



- Ships fully assembled

### HOW TO ORDER EXAMPLES

#### TABLE

|            |                |              |
|------------|----------------|--------------|
| 620-2445CT | Top Material   | W            |
|            | Finish/Color   | ORW          |
|            | Cabinet Accent | CAPPD        |
|            | Leg            | PLALUM       |
|            | Leg Finish     | -            |
|            | Power Location | C            |
|            | Power          | 01-DUOBEZELS |

### TABLE LEG OPTIONS

Plush cocktail table comes standard with Black or Aluminum Metal legs. Optional Wood Leg matches our Iconic Caseloads Collection. Must Specify Leg and Color.

|        |   |        |
|--------|---|--------|
| PLBLK  | Black Metal Leg                                   | STD    |
| PLALUM | Aluminum Metal Leg                                | STD    |
| ICON   | Wood Leg ( <i>Matches the Iconic Collection</i> ) | \$ 308 |

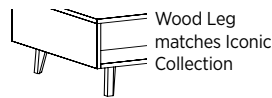

### LEG WOOD FINISHES

Indiana Furniture uses a multi-step, hand finishing process on all exposed wood. Table legs feature a catalyzed varnish finish which offers durability, lasting beauty, and resistance to normal wear.

|     |                     |     |                     |
|-----|---------------------|-----|---------------------|
| AW  | Artisan Walnut      | LW  | Legacy Walnut       |
| AS  | Asian Night         | MW  | Mahogany Walnut     |
| BW  | Beigewood*          | MO  | Medium Oak*         |
| BL  | Black               | ORW | Oak Riftwood*       |
| CO  | Columbian Walnut    | PNW | Pinnacle Walnut     |
| DC  | Dark Cherry         | SCH | Select Cherry       |
| DFW | Dark Forest Walnut* | SKC | Shaker Cherry       |
| WH  | Designer White      | SBP | Smoky Brown Pear*   |
| EW  | Espresso            | TK  | Studio Teak         |
| FO  | Fawn Oak*           | SM  | Sugar Maple         |
| GC  | Golden Cherry       | SW  | Sunglow Walnut      |
| HVM | Harvest Maple*      | WTA | Weathered Ash*      |
| HW  | Harvest Walnut      | WC  | Williamsburg Cherry |

\*Finish is Low Sheen

### VENEER TABLES WITH VENEER (W) OR HPL (P) TOP OPTIONS

Veneer tables feature UVAdvantage, an ultra-violet finish, on all exposed surfaces by utilizing roll-coat UV technology.

Veneer tables available with Veneer (W) or HPL (P) Top. Must specify Top Material and Finish Color. Tables are available with contrasting chassis and leg colors.

|     |                    |     |                       |
|-----|--------------------|-----|-----------------------|
| AW  | Artisan Walnut     | MW  | Mahogany Walnut**     |
| AS  | Asian Night**      | MO  | Medium Oak*           |
| CO  | Columbian Walnut** | ORW | Oak Riftwood*, **     |
| DC  | Dark Cherry        | SCH | Select Cherry**       |
| DFW | Dark Forest Walnut | SKC | Shaker Cherry**       |
| EF  | Espresso**         | SBP | Smoky Brown Pear**    |
| FO  | Fawn Oak*          | SM  | Sugar Maple**         |
| GC  | Golden Cherry**    | SW  | Sunglow Walnut        |
| HVM | Harvest Maple**    | WTA | Weathered Ash*, **    |
| HW  | Harvest Walnut     | WC  | Williamsburg Cherry** |
| LW  | Legacy Walnut      |     |                       |

\*Finish is Low Sheen

\*\*HPL Color Options with Veneer Tables

### TFL TABLES WITH TFL (T) OR HPL (P) TOP OPTIONS

TFL tables available with TFL (T) or HPL (P) Top. Must specify Top Material and Color.

#### WOODGRAIN

|     |                  |     |                     |
|-----|------------------|-----|---------------------|
| AS  | Asian Night      | PNW | Pinnacle Walnut     |
| BW  | Beigewood        | SCH | Select Cherry       |
| CO  | Columbian Walnut | SKC | Shaker Cherry       |
| EF  | Espresso         | SBP | Smoky Brown Pear    |
| GC  | Golden Cherry    | TK  | Studio Teak         |
| HVM | Harvest Maple    | SM  | Sugar Maple         |
| MW  | Mahogany Walnut  | WTA | Weathered Ash       |
| ORW | Oak Riftwood     | WC  | Williamsburg Cherry |

#### SOLID

|    |       |    |                |
|----|-------|----|----------------|
| BL | Black | WH | Designer White |
|----|-------|----|----------------|

### INTERIOR CABINET TABLE ACCENT HPL (P) OPTIONS



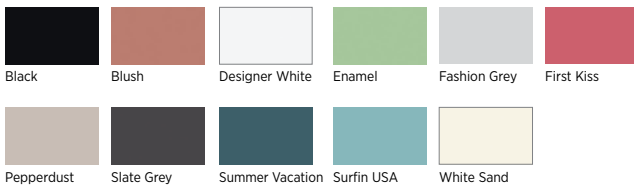

Select Veneer tables feature an optional interior HPL accent color. See specific veneer tables for details.

|       |                |       |                 |
|-------|----------------|-------|-----------------|
| CABL  | Black          | CAPPD | Pepperdust      |
| CABSH | Blush          | CASG  | Slate Grey      |
| CAWH  | Designer White | CASV  | Summer Vacation |
| CAENL | Enamel         | CASUS | Surfin USA      |
| CAFHG | Fashion Grey   | CAWHS | White Sand      |
| CAFK  | First Kiss     |       |                 |





### TABLE POWER OPTIONS

**Power Options + Locations:** Specify the grommet, power, and location.

|  |        |                         |   |        |
|--|--------|-------------------------|---|--------|
| Grommet  | Black  | <i>Specify</i><br>GBR60 |  | \$ 72  |
|  | Silver | GSR60                   |   |        |
| D150 Wireless Charger<br>Wireless & Three (3) USB Ports      | Black  | 01-DOCK150B             |  | \$ 380 |
|  | White  | 01-DOCK150W             |   |        |
| D950 Wireless & USB Charger<br>Wireless Charging             | Black  | 01-DOCK950B             |  | \$ 249 |
|  | White  | 01-DOCK950W             |   |        |
| ECA Cove<br>One (1) Electrical Power and Two (2) USB Outlets | Black  | 01-COVIUBL              |  | \$ 915 |
|  | Silver | 01-COVIUAL              |   |        |

### TABLE POWER OPTIONS CONTINUE

|  |             |               |   |         |
|--|-------------|---------------|---|---------|
| DUOBEZEL<br>Two (2) Electrical Power and Two (2) USB Outlets                             | Black       | 01-DUOBEZELB  |  | \$ 633  |
|  | White       | 01-DUOBEZELS  |   |         |
|  | Silver      | 01-DUOBEZELW  |   |         |
| TRIOBEZEL<br>Three (3) Electrical Power, Two (2) USB Outlets, and One (1) Open Data Port | Black       | 01-TRIOBEZELB |  | \$ 680  |
|  | White       | 01-TRIOBEZELS |   |         |
|  | Silver      | 01-TRIOBEZELW |   |         |
| <i>Open Port Options for TRIOBEZEL</i>   |             |               |   |         |
| VGA Date Port  | 01-LCOMVGA  |               |   | \$ 114  |
| HDMI Data Port<br>(Open Market Only)   | 01-LCOMHDMI |               |   | \$ 155  |
| RJ45 Data Port   | 01-LCOMRJ45 |               |   | \$ 74   |
| DPORT4<br>Two (2) USB Outlets, and Two (2) Open Data Port                                | Aluminum    | 01-DPORT4A    |  | \$ 1025 |
|  | Black       | 01-DPORT4B    |   |         |
| <i>Port Options for DPORTS</i>   |             |               |   |         |
| USB Port   | 01-USBPORT  |               |   | \$ 151  |
| Voice Coupler  | 01-VOICE1   |               |   | \$ 69   |
| Data Port  | 01-RJ4DATA  |               |   | \$ 156  |

### TABLE POWER LOCATIONS

|      |          |     |                          |
|------|----------|-----|--------------------------|
| NONE | None     | LC  | Left and Centered        |
| C    | Centered | RC  | Right and Centered       |
| R    | Right    | LR  | Left and Right           |
| L    | Left     | LCR | Left, Right and Centered |

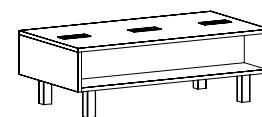

L/R: 6" from ends and 12" from front  
C: 22 1/2" from ends and 12" from front

Cocktail Table Shown with Metal Leg and Three TRIOBEZEL on Left and Right and Center

*All power options available in Left, Right and Center.*

### CERTIFICATIONS & COMPLIANCE

- CAL 117-2013 Compliance
- Intertek Sustainability Certified
- BIFMA level® Certified
- BIFMA Compliant® Certified
- TSCA Title VI (CARB) Compliance
- US Green Building's LEED® Contribution

| Item  | Model No.      |            | W  | D  | H  | Ship Wt | Cubic Ft | List Price |      |
|---|----------------|------------|----|----|----|---------|----------|------------|------|
|  | 620-2445CT     | Veneer/HPL | 45 | 24 | 15 | 77      | 9.4      | W/P\$      | 2035 |
|   | Veneer Chassis |            |    |    |    |         |          |            |      |
|   | 620-2445CTT    | TFL        | 45 | 24 | 15 | 77      | 9.4      | T\$        | 1243 |
|   | TFL Chassis    |            |    |    |    |         |          | P\$        | 1357 |
|   | HPL            |            |    |    |    |         |          |            |      |

Shown with Metal Leg

Must Specify (in this order):

- Model #
- Top Material
- Finish/Color
- Cabinet Accent Color (Veneer Only)
- Leg
- Leg Finish/Color
- Power Location
- Power

**Description**

- Standard with: Metal Legs
- Chassis Available in Veneer (W) or TFL (T)
- Top Available with Veneer (W), TFL (T) or HPL (P), Must Specify
- Primary Finish and Wood Legs Available in Contrasting Finish Colors
- 9"D Cubby Area on Both Sides of the Table
- Optional Cabinet Interior Accent Color on Veneer Tables Only; Must Specify Color, [See Color Options](#)
- Optional Wood Leg ([See Color Options](#)) and Power ([See Power Options](#))

**Veneer Table Cabinet Accent Option: Specify Color & Add**

|                                     |  |    |     |
|-------------------------------------|--|----|-----|
| Interior Cabinet Table Accent Color | Available on Veneer Tables Only; <a href="#">See Color Options</a> | \$ | 180 |
|-------------------------------------|--|----|-----|

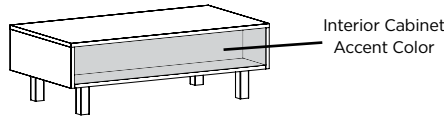



In partnership with Edge Design, a UK-based company, we welcome Spirit.

Spirit has a refined and inviting form, and capitalizes on versatility and comfort. Complete your waiting area, welcoming lobby, or office space with Spirit tables.

### CONSTRUCTION

- Non-marring nylon glides included in each leg at floor level
- Tables have 1" TFL or 1½" HPL surface thickness with 1mm PVC edge band and Square edge profile
- Bases are comprised of bent wire frames or hardwood legs securely attached to a metal substructure.
- Black or Aluminum Powder Coat, and Chrome wireframes
- Ships fully assembled

### HOW TO ORDER EXAMPLE

| Model No. | Description | Example |
|-----------|-------------|---------|
| ST11C     | Top Color   | WTA     |
|           | Base        | STWFA   |

### TFL (T) AND HPL (P) LAMINATE TABLE OPTIONS

#### WOODGRAIN

|     |                  |     |                     |
|-----|------------------|-----|---------------------|
| AS  | Asian Night      | PNW | Pinnacle Walnut     |
| BW  | Beigewood        | SCH | Select Cherry       |
| CO  | Columbian Walnut | SKC | Shaker Cherry       |
| EF  | Espresso         | SBP | Smoky Brown Pear    |
| GC  | Golden Cherry    | TK  | Studio Teak         |
| HVM | Harvest Maple    | SM  | Sugar Maple         |
| MW  | Mahogany Walnut  | WTA | Weathered Ash       |
| ORW | Oak Riftwood     | WC  | Williamsburg Cherry |

#### SOLID

|     |                |     |            |
|-----|----------------|-----|------------|
| BL  | Black          | PPD | Pepperdust |
| WH  | Designer White | SG  | Slate Grey |
| FHG | Fashion Grey   | WHS | White Sand |

### TABLE BASE OPTIONS

*Not all bases are available on each model. Check availability on pricing pages.*

|       |                                 |       |
|-------|---------------------------------|-------|
| STWFA | Wireframe, Aluminum             | N/C   |
| STWFB | Wireframe, Black                | N/C   |
| STWFC | Wireframe, Chrome               | \$ 55 |
| SLBO  | 4-Star Wood Base, Blonde Oak    | N/C   |
| SLSPW | 4-Star Wood Base, Spiced Walnut | N/C   |

### TABLE EDGE PROFILE



Square

### CERTIFICATIONS & COMPLIANCE

- Intertek Sustainability Certified
- BIFMA level® Certified
- BIFMA Compliant® Certified
- TSCA Title VI (CARB) Compliance
- US Green Building's LEED® Contribution

### STATEMENT OF LINE



Spirit Square Table

ST11C: TFL  
ST11CH: HPL  
[\(See Details\)](#)

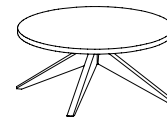

Spirit Round Table

SLT-1W: TFL  
SLT-1WH: HPL  
[\(See Details\)](#)

| Item                | Model No. |     | W  | D  | H  | Ship Wt | Cubic Ft | List Price |     |
|---------------------|-----------|-----|----|----|----|---------|----------|------------|-----|
| SPIRIT SQUARE TABLE | ST11C     | TFL | 27 | 27 | 17 | 31      | 11.4     | T\$        | 797 |
|                     | ST11CH    | HPL | 27 | 27 | 17 | 31      | 11.4     | P\$        | 962 |

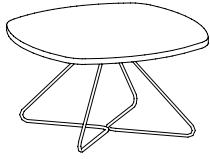

Must Specify (in this order):

- Model #
- Top Color
- Base Color

**Description**

- Standard with: 1" TFL Top or 1½" HPL Top and Wireframe Base; Must Specify Color
- Features Square Edge Profile

**Leg Option: Specify & Add**

|       |                     |       |
|-------|---------------------|-------|
| STWFA | Wireframe, Aluminum | N/C   |
| STWFB | Wireframe, Black    | N/C   |
| STWFC | Wireframe, Chrome   | \$ 55 |

|                    |         |     |     |     |     |    |      |     |      |
|--------------------|---------|-----|-----|-----|-----|----|------|-----|------|
| SPIRIT ROUND TABLE | SLT-1W  | TFL | 31½ | 31½ | 14½ | 31 | 11.4 | T\$ | 1405 |
|                    | SLT-1WH | HPL | 31½ | 31½ | 14½ | 31 | 11.4 | P\$ | 1557 |

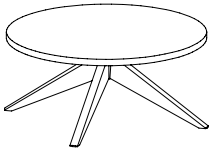

Must Specify (in this order):

- Model #
- Top Color
- Base Color

**Description**

- Standard with: 1" TFL Top or 1½" HPL Top and 4-Star Swivel Wood Base (Select Blonde Oak or Spiced Walnut)
- Features Square Edge Profile



Square

T = TFL P = HPL

Topsy table's classic square style is a go-to when you need an understated table with looks that say reliability. Turvy tables give an extra punch of style with the tapered legs and curvy appeal. Both available in wood, laminate, or solid surface tops with powder coated metal frames in five colors.

### CONSTRUCTION

- Square and Rectangular models feature a 1" thick top; Round models feature ¾" thick top
- Veneer tops are made of select grade, sliced Black Walnut, Oak, Cherry, Maple, or Composite species
- TFL Laminate tops have a 1mm PVC edge band
- Solid surface tops are available in six colors and two edge profiles
- Bases are manufactured using steel frames and powder coated in your choice of five standard colors
- Joints on bases are mitered and fully welded for maximum strength and durability
- Tops are securely fastened to the bases with metal screws
- Ships fully assembled

### HOW TO ORDER EXAMPLES

|            |                                |      |
|------------|--------------------------------|------|
| 521-2626ET | Top Material                   | S    |
|            | Finish                         | AR   |
|            | Edge Detail<br>(if applicable) | S1   |
|            | Metal Base Color               | MIST |

### TFL (T) LAMINATE TABLE TOP OPTIONS

#### WOODGRAIN

|     |                  |     |                     |
|-----|------------------|-----|---------------------|
| AS  | Asian Night      | PNW | Pinnacle Walnut     |
| BW  | Beigewood        | SCH | Select Cherry       |
| CO  | Columbian Walnut | SKC | Shaker Cherry       |
| EF  | Espresso         | SBP | Smoky Brown Pear    |
| GC  | Golden Cherry    | TK  | Studio Teak         |
| HVM | Harvest Maple    | SM  | Sugar Maple         |
| MW  | Mahogany Walnut  | WTA | Weathered Ash       |
| ORW | Oak Riftwood     | WC  | Williamsburg Cherry |

#### SOLID

|     |                |     |            |
|-----|----------------|-----|------------|
| BL  | Black          | PPD | Pepperdust |
| WH  | Designer White | SG  | Slate Grey |
| FHG | Fashion Grey   | WHS | White Sand |

### VENEER (W) TABLE TOP OPTIONS

Tops feature UVAdvantage, an ultra-violet finish, on all exposed surfaces by utilizing roll-coat UV technology.

|     |                    |     |                     |
|-----|--------------------|-----|---------------------|
| AW  | Artisan Walnut     | MW  | Mahogany Walnut     |
| AS  | Asian Night        | MO  | Medium Oak*         |
| CO  | Columbian Walnut   | ORW | Oak Riftwood*       |
| DC  | Dark Cherry        | SCH | Select Cherry       |
| DFW | Dark Forest Walnut | SKC | Shaker Cherry       |
| EF  | Espresso           | SBP | Smoky Brown Pear    |
| FO  | Fawn Oak*          | SM  | Sugar Maple         |
| GC  | Golden Cherry      | SW  | Sunglow Walnut      |
| HVM | Harvest Maple      | WTA | Weathered Ash*      |
| HW  | Harvest Walnut     | WC  | Williamsburg Cherry |
| LW  | Legacy Walnut      |     |                     |

\* Finish is Low Sheen

### SOLID SURFACE (S) TABLE TOP OPTIONS

|    |              |     |              |
|----|--------------|-----|--------------|
| AR | Arroyo       | SNW | Snow White   |
| PE | Pebble Beach | SN  | Starry Night |
| SE | Sedona       | TN  | Tundra       |

### SOLID SURFACE EDGE PROFILE OPTIONS

|    |          |
|----|----------|
| S1 | Straight |
| S2 | Roman    |

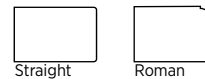

### METAL BASE OPTIONS

|      |              |
|------|--------------|
| ALUM | Aluminum     |
| MIST | Mist         |
| NOIR | Noir         |
| OYST | Oyster       |
| SUGC | Sugar Cookie |

### CERTIFICATIONS & COMPLIANCE

- Intertek Sustainability Certified
- BIFMA level® Certified
- BIFMA Compliant® Certified
- TSCA Title VI (CARB) Compliance
- US Green Building's LEED® Contribution

### STATEMENT OF LINE



521-2626ET:  
Square End Table  
([See Details](#))

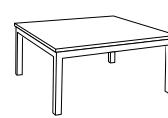

521-4040MT: Square  
Magazine Table  
([See Details](#))

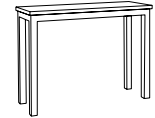

521-4014CT:  
Rectangular Console  
Table  
([See Details](#))



521-2626RET:  
Round End Table  
([See Details](#))

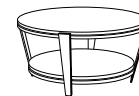

521-4040RMT:  
Round Magazine  
Table  
([See Details](#))



521-4014RCT:  
Round Console  
Table  
([See Details](#))

| Item   | Model No.  |               | W   | D   | H   | Ship Wt | Cubic Ft | List Price |      |      |
|--|------------|---------------|-----|-----|-----|---------|----------|------------|------|------|
| <b>SQUARE END TABLE</b><br> | 521-2626ET | TFL           | 26¼ | 26¼ | 26¾ | 48      | 13.2     | T\$        | 2258 |      |
|  |            | Veneer        |     |     |     |         |          |            | W\$  | 2388 |
|  |            | Solid Surface |     |     |     |         |          |            | S\$  | 3893 |

**Description**

- Standard with: 2" Powder Coated Steel Metal Base and Adjustable Levelers
- Select Your Choice of TFL (T), Veneer (W), or Solid Surface (S) Top
- [See Top Options, Base Color Options and Specify](#)

Must Specify (in this order):

Model #  
 Top Material  
 Edge (if applicable)  
 Base Color

|   |            |               |     |     |     |    |      |     |      |      |
|---|------------|---------------|-----|-----|-----|----|------|-----|------|------|
| <b>SQUARE MAGAZINE TABLE</b><br> | 521-4040MT | TFL           | 40½ | 40½ | 18¾ | 78 | 20.4 | T\$ | 2595 |      |
|   |            | Veneer        |     |     |     |    |      |     | W\$  | 2836 |
|   |            | Solid Surface |     |     |     |    |      |     | S\$  | 6572 |

**Description**

- Standard with: 2" Powder Coated Steel Metal Base and Adjustable Levelers
- Select Your Choice of TFL (T), Veneer (W), or Solid Surface (S) Top
- [See Top Options, Base Color Options and Specify](#)

Must Specify (in this order):

Model #  
 Top Material  
 Edge (if applicable)  
 Base Color

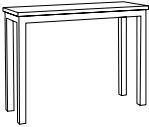
|   |            |               |     |    |     |    |      |     |      |      |
|---|------------|---------------|-----|----|-----|----|------|-----|------|------|
| <b>RECTANGULAR CONSOLE TABLE</b><br> | 521-4014CT | TFL           | 40½ | 14 | 30¾ | 50 | 12.5 | T\$ | 2416 |      |
|   |            | Veneer        |     |    |     |    |      |     | W\$  | 2533 |
|   |            | Solid Surface |     |    |     |    |      |     | S\$  | 4022 |

**Description**

- Standard with: 2" Powder Coated Steel Metal Base and Adjustable Levelers
- Select Your Choice of TFL (T), Veneer (W), or Solid Surface (S) Top
- [See Top Options, Base Color Options and Specify](#)

Must Specify (in this order):

Model #  
 Top Material  
 Edge (if applicable)  
 Base Color

T = TFL W = Veneer S = Solid Surface

[See Intro Overview For Ordering Options](#)



# TOPSY TURVY™

## COCKTAIL, END + MAGAZINE TABLES (521 SERIES)

| Item   | Model No.   |               | W   | D   | H   | Ship Wt | Cubic Ft | List Price |      |
|--|-------------|---------------|-----|-----|-----|---------|----------|------------|------|
| ROUND END TABLE<br> | 521-2626RET | TFL           | 26¼ | 26¼ | 26¾ | 36      | 13.2     | T\$        | 2047 |
|  |             | Veneer        |     |     |     |         |          | W\$        | 2345 |
|  |             | Solid Surface |     |     |     |         |          | S\$        | 4531 |

**Description**

- Standard with: Tapered Steel Metal Base and Lower Storage Shelf
- Select Your Choice of TFL (T), Veneer (W), or Solid Surface (S) Top
- [See Top Options, Base Color Options and Specify](#)

Must Specify (in this order):

Model #  
Top Material  
Edge (if applicable)  
Base Color

|   |             |               |     |     |     |    |      |     |      |
|---|-------------|---------------|-----|-----|-----|----|------|-----|------|
| ROUND MAGAZINE TABLE<br> | 521-4040RMT | TFL           | 40½ | 40½ | 18¾ | 63 | 20.4 | T\$ | 2389 |
|   |             | Veneer        |     |     |     |    |      | W\$ | 3031 |
|   |             | Solid Surface |     |     |     |    |      | S\$ | 7842 |

**Description**

- Standard with: Tapered Steel Metal Base and Lower Storage Shelf
- Select Your Choice of TFL (T), Veneer (W), or Solid Surface (S) Top
- [See Top Options, Base Color Options and Specify](#)

Must Specify (in this order):

Model #  
Top Material  
Edge (if applicable)  
Base Color

|  |             |               |     |    |     |    |      |     |      |
|--|-------------|---------------|-----|----|-----|----|------|-----|------|
| ROUND CONSOLE TABLE<br> | 521-4014RCT | TFL           | 40½ | 14 | 30¾ | 38 | 12.5 | T\$ | 2303 |
|  |             | Veneer        |     |    |     |    |      | W\$ | 2659 |
|  |             | Solid Surface |     |    |     |    |      | S\$ | 4404 |

**Description**

- Standard with: Tapered Steel Metal Base and Lower Storage Shelf
- Select Your Choice of TFL (T), Veneer (W), or Solid Surface (S) Top
- [See Top Options, Base Color Options and Specify](#)

Must Specify (in this order):

Model #  
Top Material  
Edge (if applicable)  
Base Color

T = TFL W = Veneer S = Solid Surface

[See Intro Overview For Ordering Options](#)



# Space Division

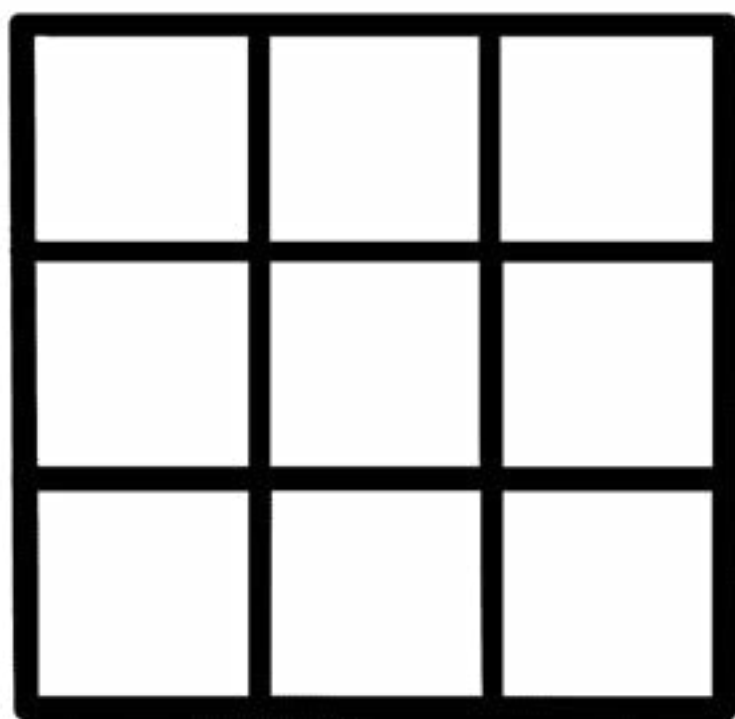

Our functional range of screens and dividers make it easy to create space division within any environment, on nearly any product. Simply add screens to your worksurface, training table, and/or reception desk to create privacy, add protection, or further define personal space.

## CONSTRUCTION

### ACRYLIC PANELS/SCREENS/DIVIDERS

- Clear and Frosted Acrylics are ¼" thick, while High Gloss Acrylics are ¾" thick; cut to size and machined for a clean finish

### TFL PANELS/SCREENS/DIVIDERS

- Made of woodgrain and solid color laminates fused to particle-board core
- Privacy Panels and Above/Below Screens are ¾" thick
- Gallery Screens are 1" thick
- Each laminate offers lasting beauty, superior resistance to normal wear, and easy maintenance

### VENEER PANELS/SCREENS/DIVIDERS

- Made of select-grade, plain sliced hardwood Cherry, Maple, American Black Walnut, White Oak, or composite veneers; selected and matched to assure proper balance and consistency
- Privacy Panels and Above/Below Screens are ¾" thick
- Gallery Screens are 1" thick
- Veneers feature Indiana Furniture's sustainable UVAdvantage, an ultra-violet topcoat finish, on all exposed surfaces by utilizing roll-coat UV technology

### WIRE MANAGEMENT

- Grommets may be specified for 51"H, 42"H, and 30"H Straight Floorstanding Gallery Screens, and are available in black or silver

## CERTIFICATIONS & COMPLIANCE

- CAL 117-2013 Compliance
- Intertek Sustainability Certified
- BIFMA level® Certified
- BIFMA Compliant Certified
- TSCA Title VI (CARB) Compliance
- US Green Building's LEED Contribution

## HOW TO ORDER EXAMPLES

| SCREEN  | QTY | MODEL NO.   | DESCRIPTION | EXAMPLE |
|---------|-----|-------------|-------------|---------|
| DIVIDER | 2   | 01-4224SDCA |             |         |

| ABOVE & BELOW | QTY | MODEL NO.  | DESCRIPTION | EXAMPLE |
|---------------|-----|------------|-------------|---------|
|               | 1   | 01-6235ABA | Hardware    | ALUM    |

| PRIVACY PANEL | QTY | MODEL NO.  | DESCRIPTION | EXAMPLE |
|---------------|-----|------------|-------------|---------|
|               | 4   | 01-5624PPA | Hardware    | CHRM    |

| GALLERY SCREEN | QTY | MODEL NO. | DESCRIPTION | EXAMPLE |
|----------------|-----|-----------|-------------|---------|
|                | 4   | 65-5173GS | Finish      | WTA     |
|                |     |           | Grommet     | DGL, BL |
|                |     |           | Grommet     | DGR, BL |
|                |     |           | Grommet     | DGC, BL |

## SUPPORT BLOCKS/ATTACHMENT HARDWARE COLOR OPTIONS

|      |          |
|------|----------|
| ALUM | Aluminum |
| CHRM | Chrome   |

## TFL (T) LAMINATE OPTIONS

### WOODGRAIN

|     |                  |     |                     |
|-----|------------------|-----|---------------------|
| AS  | Asian Night      | PNW | Pinnacle Walnut     |
| BW  | Beigewood        | SCH | Select Cherry       |
| CO  | Columbian Walnut | SKC | Shaker Cherry       |
| EF  | Espresso         | SBP | Smoky Brown Pear    |
| GC  | Golden Cherry    | TK  | Studio Teak         |
| HVM | Harvest Maple    | SM  | Sugar Maple         |
| MW  | Mahogany Walnut  | WTA | Weathered Ash       |
| ORW | Oak Riftwood     | WC  | Williamsburg Cherry |

### SOLID

|     |                |     |            |
|-----|----------------|-----|------------|
| BL  | Black          | PPD | Pepperdust |
| WH  | Designer White | SG  | Slate Grey |
| FHG | Fashion Grey   | WHS | White Sand |

## VENEER (W) OPTIONS

|     |                    |     |                     |
|-----|--------------------|-----|---------------------|
| AW  | Artisan Walnut     | MW  | Mahogany Walnut     |
| AS  | Asian Night        | MO  | Medium Oak*         |
| CO  | Columbian Walnut   | ORW | Oak Riftwood*       |
| DC  | Dark Cherry        | SCH | Select Cherry       |
| DFW | Dark Forest Walnut | SKC | Shaker Cherry       |
| EW  | Espresso           | SBP | Smoky Brown Pear    |
| FO  | Fawn Oak*          | SM  | Sugar Maple         |
| GC  | Golden Cherry      | SW  | Sunglow Walnut      |
| HVM | Harvest Maple      | WTA | Weathered Ash*      |
| HW  | Harvest Walnut     | WC  | Williamsburg Cherry |
| LW  | Legacy Walnut      |     |                     |

\* Finish is Low Sheen

## HIGH GLOSS ACRYLIC OPTIONS

|     |  |
|-----|--|
| BLA | Black High Gloss Acrylic               |
| GPA | Graphite High Gloss Acrylic (upcharge) |
| WHA | White High Gloss Acrylic               |

## GALLERY SCREEN GROMMET OPTIONS & LOCATIONS

Multiple grommets may be ordered for each screen.  
Must Specify Model and Color: Black (BLK) or Silver (SLV).

### 51"H and 42"H Gallery Screens

|     |  |       |
|-----|--|-------|
| DGL | Desk Height Left; 6" from end, 5¼" from bottom   | \$ 72 |
| DGR | Desk Height Right; 6" from end, 25¼" from bottom | \$ 72 |
| DGC | Desk Height Center; 25¼" from bottom             | \$ 72 |
| BGL | Bench Height Left; 6" from end, 15" from bottom  | \$ 72 |
| BGR | Bench Height Right; 6" from end, 15" from bottom | \$ 72 |
| BGC | Bench Height Center; 15" from bottom             | \$ 72 |

### 30"H Gallery Screens

|     |  |       |
|-----|--|-------|
| BGL | Bench Height Left; 6" from end, 15" from bottom  | \$ 72 |
| BGR | Bench Height Right; 6" from end, 15" from bottom | \$ 72 |
| BGC | Bench Height Center; 15" from bottom             | \$ 72 |

Grommets may be ordered in non-standard locations. Call Customer Service to assist with specification. Note additional charges and lead times may apply.

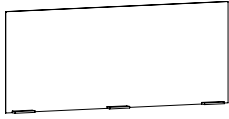

**24" H Privacy Panels**  
 Available in Clear and Frosted Acrylic  
 ([See Details](#))



**12" H Privacy Panels**  
 Available in Frosted and High Gloss  
 Acrylic, TFL, and Veneer  
 ([See Details](#))

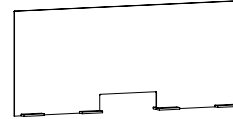

**24" H Privacy Panels with Transaction Slot**  
 Available in Clear Acrylic  
 ([See Details](#))



**24" H Screen Dividers**  
 Available in Clear and Frosted Acrylic  
 ([See Details](#))

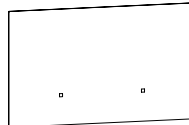

**33" H Above & Below Screens**  
 Available in Frosted Acrylic  
 ([See Details](#))



**21" H Above & Below Screen**  
 Available in Frosted and High Gloss  
 Acrylic, TFL, and Veneer  
 ([See Details](#))



**20" H Above & Below Screens**  
 Available in Frosted and High Gloss  
 Acrylic, Tackboard, TFL, and Veneer  
 ([See Details](#))



**17" H Above & Below Screens**  
 Available in Frosted and High Gloss  
 Acrylic, Tackboard, TFL, and Veneer  
 ([See Details](#))

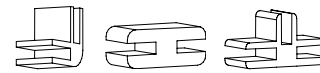

**2-Way & 3-Way Connector Clips**  
 Corner, T, and Straight Connectors for  
 Clear and Frosted Acrylic Options  
 ([See Details](#))

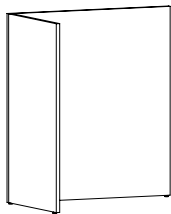

**51" H L-Gallery Screens**  
 Available in TFL and Veneer  
 ([See Details](#))

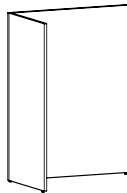

**42" H L-Gallery Screens**  
 Available in TFL and Veneer  
 ([See Details](#))

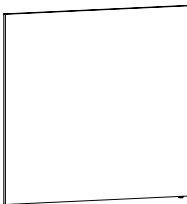

**51" H Straight Gallery Screens**  
 Available in TFL and Veneer  
 ([See Details](#))

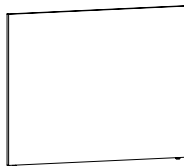

**42" H Straight Gallery Screens**  
 Available in TFL and Veneer  
 ([See Details](#))



**30" H Straight Gallery Screens**  
 Available in TFL and Veneer  
 ([See Details](#))

# SCREENS+DIVIDERS

IDEA STARTERS

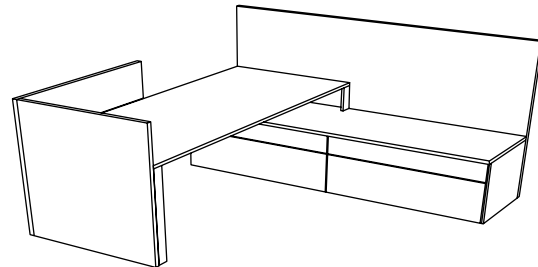
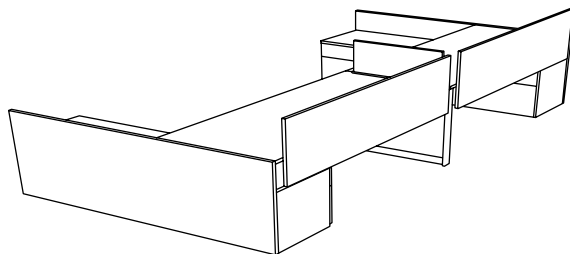
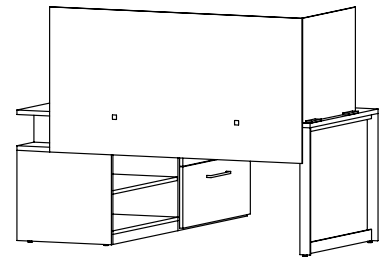
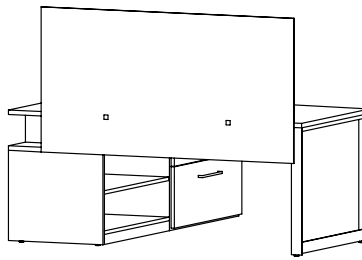
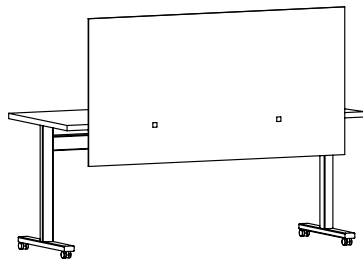
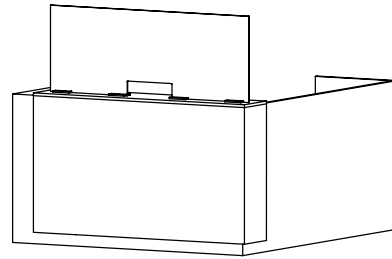
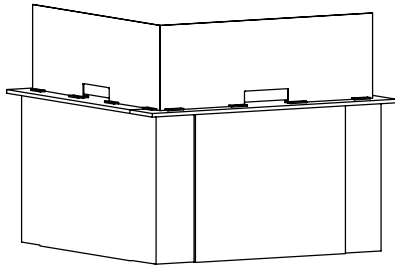
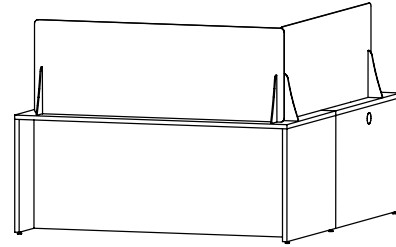
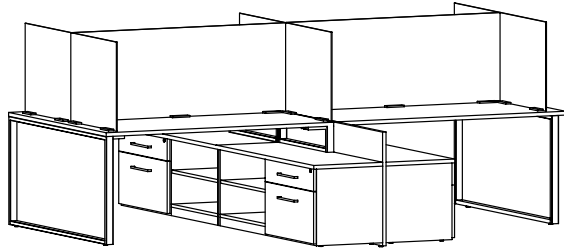

| Item   | Model No.   |         | W  | D | H   | Ship Wt | Cubic Ft | List Price |
|--|-------------|---------|----|---|-----|---------|----------|------------|
| 24"H PRIVACY PANELS<br> | 01-6224PPCA | Clear   | 62 | ¼ | 23½ | 13.9    | 2.1      | C\$ 1090   |
|  | 01-6224PPA  | Frosted |    |   |     |         |          | F\$ 1367   |
|  | 01-5624PPCA | Clear   | 56 | ¼ | 23½ | 11.5    | 1.9      | C\$ 1020   |
|  | 01-5624PPA  | Frosted |    |   |     |         |          | F\$ 1275   |
|  | 01-2824PPCA | Clear   | 28 | ¼ | 23½ | 5.8     | 1.4      | C\$ 644    |
|  | 01-2824PPA  | Frosted |    |   |     |         |          | F\$ 780    |
|  | 01-2224PPCA | Clear   | 22 | ¼ | 23½ | 4.8     | 1.2      | C\$ 576    |
|  | 01-2224PPA  | Frosted |    |   |     |         |          | F\$ 687    |

**Description**

- Sets on Surface; Comes with Non-Marring, Removable Adhesive Strip for Surface Attachment
- Available in Clear or Frosted Acrylic
- Acrylic Connector Clips are Recommended for Support on 90° Corner, T Shaped and Straight Applications, [See Connector Clip Details](#)
- Decorative Support Blocks; Must Specify: Aluminum (ALUM) or Chrome (CHRM)
- Some Assembly Required
- SIN NEW

| Item   | Model No.   |                     | W  | D | H  | Ship Wt | Cubic Ft | List Price |
|--|-------------|---------------------|----|---|----|---------|----------|------------|
| 12"H PRIVACY PANELS<br> | 66-6812PPA  | Frosted             | 68 | ¼ | 12 | 8       | 2.2      | F\$ 921    |
|  | 66-6812PPGA | High Gloss          | 68 | ¾ | 12 | 25      | 2.3      | HG\$ 985   |
|  | 66-6812PPGA | High Gloss Graphite | 68 | ¾ | 12 | 25      | 2.3      | GR\$ 1156  |
|  | 66-6812PP   | TFL                 | 68 | ¾ | 12 | 26      | 2.2      | T\$ 430    |
|  | 65-6812PP   | Veneer              | 68 | ¾ | 12 | 26      | 2.2      | W\$ 714    |
|  | 66-6212PPA  | Frosted             | 62 | ¼ | 12 | 7       | 2.0      | F\$ 868    |
|  | 66-6212PPGA | High Gloss          | 62 | ¾ | 12 | 23      | 2.1      | HG\$ 918   |
|  | 66-6212PPGA | High Gloss Graphite | 62 | ¾ | 12 | 23      | 2.1      | GR\$ 1083  |
|  | 66-6212PP   | TFL                 | 62 | ¾ | 12 | 25      | 2.0      | T\$ 419    |
|  | 65-6212PP   | Veneer              | 62 | ¾ | 12 | 25      | 2.0      | W\$ 699    |
|  | 66-5612PPA  | Frosted             | 56 | ¼ | 12 | 6       | 1.8      | F\$ 801    |
|  | 66-5612PPGA | High Gloss          | 56 | ¾ | 12 | 22      | 1.9      | HG\$ 831   |
|  | 66-5612PPGA | High Gloss Graphite | 56 | ¾ | 12 | 22      | 1.9      | GR\$ 1007  |
|  | 66-5612PP   | TFL                 | 56 | ¾ | 12 | 23      | 1.8      | T\$ 409    |
|  | 65-5612PP   | Veneer              | 56 | ¾ | 12 | 23      | 1.8      | W\$ 679    |
|  | 66-2812PPA  | Frosted             | 28 | ¼ | 12 | 8       | 0.7      | F\$ 544    |
|  | 66-2812PPGA | High Gloss          | 28 | ¾ | 12 | 13      | 0.9      | HG\$ 571   |
|  | 66-2812PPGA | High Gloss Graphite | 28 | ¾ | 12 | 13      | 0.9      | GR\$ 644   |
|  | 66-2812PP   | TFL                 | 28 | ¾ | 12 | 12      | 0.9      | T\$ 355    |
|  | 65-2812PP   | Veneer              | 28 | ¾ | 12 | 12      | 0.9      | W\$ 587    |
|  | 66-2212PPA  | Frosted             | 22 | ¼ | 12 | 7       | 0.6      | F\$ 490    |
|  | 66-2212PPGA | High Gloss          | 22 | ¾ | 12 | 11      | 0.7      | HG\$ 513   |
|  | 66-2212PPGA | High Gloss Graphite | 22 | ¾ | 12 | 11      | 0.7      | GR\$ 568   |
|  | 66-2212PP   | TFL                 | 22 | ¾ | 12 | 10      | 0.7      | T\$ 346    |
|  | 65-2212PP   | Veneer              | 22 | ¾ | 12 | 10      | 0.7      | W\$ 574    |

**Description**

- Sets on Surface
- Available in Frosted or High Gloss Acrylic, TFL, or Veneer; Must Specify; See [TFL Colors](#) or [Veneer Finish](#), and See [High Gloss Acrylic Colors](#)
- Decorative Support Blocks; Must Specify: Aluminum (ALUM) or Chrome (CHRM)
- Some Assembly Required

**Pricing Codes:** C=Clear F= Frosted HG= High Gloss GR= High Gloss Graphite T = TFL W = Veneer

For ordering options, see overview at the beginning of section.



# SCREENS+DIVIDERS

## MULTI-USE SPACE DIVISION

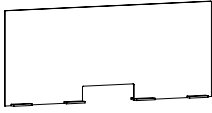
| Item   | Model No.    |       | W  | D | H   | Ship Wt | Cubic Ft | List Price |
|--|--------------|-------|----|---|-----|---------|----------|------------|
| 24"H PRIVACY PANELS WITH TRANSACTION SLOT<br> | 01-6224PPSCA | Clear | 62 | ¼ | 23½ | 13.9    | 2.1      | \$ 1152    |
|  | 01-5624PPSCA | Clear | 56 | ¼ | 23½ | 11.5    | 1.9      | \$ 1083    |
|  | 01-5024PPSCA | Clear | 50 | ¼ | 23½ | 9.1     | 1.7      | \$ 890     |
|  | 01-4424PPSCA | Clear | 44 | ¼ | 23½ | 6.7     | 1.5      | \$ 822     |
|  | 01-3824PPSCA | Clear | 38 | ¼ | 23½ | 4.3     | 1.2      | \$ 756     |

**Description**

- Sets on Surface; Comes with Non-Marring Adhesive Strip for Additional Surface Attachment
- Available in Clear Acrylic
- Decorative Support Blocks; Must Specify: Aluminum (ALUM) or Chrome (CHRM)
- Transaction Slot (14"Wx4"H) Always Centered On Panel Along Bottom Edge
- Some Assembly Required
- SIN NEW

| Item   | Model No.   |         | W  | D | H   | Ship Wt | Cubic Ft | List Price |
|--|-------------|---------|----|---|-----|---------|----------|------------|
| 24"H SCREEN DIVIDERS<br> | 01-6624SDCA | Clear   | 66 | ¼ | 23½ | 11.8    | 4.7      | C\$ 1099   |
|  | 01-6624SDA  | Frosted |    |   |     |         |          | F\$ 1336   |
|  | 01-6024SDCA | Clear   | 60 | ¼ | 23½ | 10.8    | 4.2      | C\$ 1027   |
|  | 01-6024SDA  | Frosted |    |   |     |         |          | F\$ 1245   |
|  | 01-5424SDCA | Clear   | 54 | ¼ | 23½ | 9.8     | 3.7      | C\$ 955    |
|  | 01-5424SDA  | Frosted |    |   |     |         |          | F\$ 1151   |
|  | 01-4824SDCA | Clear   | 48 | ¼ | 23½ | 8.8     | 3.2      | C\$ 881    |
|  | 01-4824SDA  | Frosted |    |   |     |         |          | F\$ 1056   |
|  | 01-4224SDCA | Clear   | 42 | ¼ | 23½ | 7.8     | 2.7      | C\$ 811    |
|  | 01-4224SDA  | Frosted |    |   |     |         |          | F\$ 962    |
|  | 01-3624SDCA | Clear   | 36 | ¼ | 23½ | 6.8     | 2.2      | C\$ 715    |
|  | 01-3624SDA  | Frosted |    |   |     |         |          | F\$ 840    |
|  | 01-3024SDCA | Clear   | 30 | ¼ | 23½ | 5.8     | 1.7      | C\$ 665    |
|  | 01-3024SDA  | Frosted |    |   |     |         |          | F\$ 779    |
|  | 01-2424SDCA | Clear   | 24 | ¼ | 23½ | 4.8     | 1.2      | C\$ 561    |
|  | 01-2424SDA  | Frosted |    |   |     |         |          | F\$ 686    |

**Description**

- Freestanding on Surface
- Available in Clear and Frosted Acrylic
- Supports Constructed of Acrylic; Will Match Screen
- Some Assembly Required
- SIN NEW

**Pricing Codes:** C=Clear F= Frosted

For ordering options, see overview at the beginning of section.

# SCREENS+DIVIDERS

## MULTI-USE SPACE DIVISION

| Item                         | Model No.  |         | W  | D | H  | Ship Wt | Cubic Ft | List Price |
|------------------------------|------------|---------|----|---|----|---------|----------|------------|
| 33"H ABOVE AND BELOW SCREENS | 01-6233ABA | Frosted | 62 | ¼ | 33 | 13      | 3.5      | \$ 1681    |
|                              | 01-5633ABA | Frosted | 56 | ¼ | 33 | 12      | 2.9      | \$ 1555    |
|                              | 01-5033ABA | Frosted | 50 | ¼ | 33 | 11      | 2.3      | \$ 1429    |
|                              | 01-4433ABA | Frosted | 44 | ¼ | 33 | 10      | 1.7      | \$ 1303    |

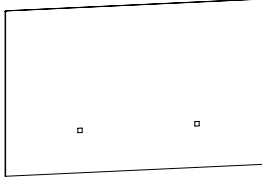
**Description**

- Mounts to Surface
- Available in Frosted Acrylic
- Provides Privacy 24" Above Surface and Modesty 8" Below Surface
- Decorative Attachment Hardware; Must Specify: Aluminum (ALUM) or Chrome (CHRM)
- SIN NEW

| Item                         | Model No.   |                     | W  | D | H  | Ship Wt | Cubic Ft | List Price |
|------------------------------|-------------|---------------------|----|---|----|---------|----------|------------|
| 21"H ABOVE AND BELOW SCREENS | 66-6821ABA  | Frosted             | 68 | ¼ | 21 | 14      | 3.3      | F\$ 1268   |
|                              | 66-6821ABGA | High Gloss          | 68 | ¾ | 21 | 44      | 3.3      | HG\$ 1357  |
|                              | 66-6821ABGA | High Gloss Graphite | 68 | ¾ | 21 | 44      | 3.3      | GR\$ 1769  |
|                              | 66-6821AB   | TFL                 | 68 | ¾ | 21 | 41      | 3.3      | T\$ 472    |
|                              | 65-6821AB   | Veneer              | 68 | ¾ | 21 | 41      | 3.3      | W\$ 788    |
|                              | 66-6221ABA  | Frosted             | 62 | ¼ | 21 | 12      | 2.8      | F\$ 1186   |
|                              | 66-6221ABGA | High Gloss          | 62 | ¾ | 21 | 41      | 3        | HG\$ 1261  |
|                              | 66-6221ABGA | High Gloss Graphite | 62 | ¾ | 21 | 41      | 3        | GR\$ 1639  |
|                              | 66-6221AB   | TFL                 | 62 | ¾ | 21 | 39      | 3        | T\$ 459    |
|                              | 65-6221AB   | Veneer              | 62 | ¾ | 21 | 39      | 3        | W\$ 763    |
|                              | 66-5621ABA  | Frosted             | 56 | ¼ | 21 | 10      | 2.6      | F\$ 1104   |
|                              | 66-5621ABGA | High Gloss          | 56 | ¾ | 21 | 38      | 2.7      | HG\$ 1169  |
|                              | 66-5621ABGA | High Gloss Graphite | 56 | ¾ | 21 | 38      | 2.7      | GR\$ 1507  |
|                              | 66-5621AB   | TFL                 | 56 | ¾ | 21 | 36      | 2.7      | T\$ 442    |
|                              | 65-5621AB   | Veneer              | 56 | ¾ | 21 | 36      | 2.7      | W\$ 734    |
|                              | 66-5021ABA  | Frosted             | 50 | ¼ | 21 | 9       | 2.2      | F\$ 1020   |
|                              | 66-5021ABGA | High Gloss          | 50 | ¾ | 21 | 36      | 2.4      | HG\$ 1076  |
|                              | 66-5021ABGA | High Gloss Graphite | 50 | ¾ | 21 | 36      | 2.4      | GR\$ 1379  |
|                              | 66-5021AB   | TFL                 | 50 | ¾ | 21 | 34      | 2.4      | T\$ 425    |
|                              | 65-5021AB   | Veneer              | 50 | ¾ | 21 | 34      | 2.4      | W\$ 708    |
|                              | 66-4421ABA  | Frosted             | 44 | ¼ | 21 | 8       | 1.2      | F\$ 936    |
|                              | 66-4421ABGA | High Gloss          | 44 | ¾ | 21 | 33      | 2.2      | HG\$ 985   |
|                              | 66-4421ABGA | High Gloss Graphite | 44 | ¾ | 21 | 33      | 2.2      | GR\$ 1250  |
|                              | 66-4421AB   | TFL                 | 44 | ¾ | 21 | 31      | 2.2      | T\$ 409    |
|                              | 65-4421AB   | Veneer              | 44 | ¾ | 21 | 31      | 2.2      | W\$ 679    |

**Description**

- Mounts to Surface
- Available in Frosted or High Gloss Acrylic, TFL, or Veneer; Must Specify; See [TFL Colors](#) or [Veneer Finish](#), and See [High Gloss Acrylic Colors](#)
- Provides Privacy 12" Above Surface and Modesty 8" Below Surface
- Decorative Attachment Hardware on Frosted Acrylic; Must Specify: Aluminum (ALUM) or Chrome (CHRM)

**Pricing Codes:** F= Frosted HG= High Gloss GR= High Gloss Graphite T = TFL W = Veneer

For ordering options, see overview at the beginning of section.

# SCREENS+DIVIDERS

## MULTI-USE SPACE DIVISION

| Item   | Model No.           |                     | W  | D  | H  | Ship Wt | Cubic Ft      | List Price    |
|--|---------------------|---------------------|----|----|----|---------|---------------|---------------|
| 20" H ABOVE AND BELOW SCREENS<br> | PS-5720FA           | Frosted             | 57 | ¼  | 20 | 20      | 2.2           | F\$ 1091      |
|  | PS-5720HGA          | High Gloss          | 57 | ¾  | 20 | 36      | 2.7           | HG\$ 1153     |
|  | PS-5720HGA          | High Gloss Graphite | 57 | ¾  | 20 | 36      | 2.7           | GR\$ 1487     |
|  | PS-5720TB           | Tackboard           | 57 | ⅝  | 20 | 14      | 2.2           | U\$ see below |
|  | 66-5720PS           | TFL                 | 57 | ¾  | 20 | 36      | 2.7           | T\$ 439       |
|  | 65-5720PS           | Veneer              | 57 | ¾  | 20 | 36      | 2.7           | W\$ 720       |
|  | PS-5120FA           | Frosted             | 51 | ¼  | 20 | 19      | 2.1           | F\$ 1009      |
|  | PS-5120HGA          | High Gloss          | 51 | ¾  | 20 | 34      | 2.5           | HG\$ 1061     |
|  | PS-5120HGA          | High Gloss Graphite | 51 | ¾  | 20 | 34      | 2.5           | GR\$ 1361     |
|  | PS-5120TB           | Tackboard           | 51 | ⅝  | 20 | 13      | 2.2           | U\$ see below |
|  | 66-5120PS           | TFL                 | 51 | ¾  | 20 | 34      | 2.5           | T\$ 420       |
|  | 65-5120PS           | Veneer              | 51 | ¾  | 20 | 34      | 2.5           | W\$ 696       |
|  | PS-4520FA           | Frosted             | 45 | ¼  | 20 | 19      | 2.0           | F\$ 927       |
|  | PS-4520HGA          | High Gloss          | 45 | ¾  | 20 | 32      | 2.3           | HG\$ 968      |
|  | PS-4520HGA          | High Gloss Graphite | 45 | ¾  | 20 | 32      | 2.3           | GR\$ 1232     |
|  | PS-4520TB           | Tackboard           | 45 | ⅝  | 20 | 12      | 2.0           | U\$ see below |
|  | 66-4520PS           | TFL                 | 45 | ¾  | 20 | 32      | 2.3           | T\$ 406       |
|  | 65-4520PS           | Veneer              | 45 | ¾  | 20 | 32      | 2.3           | W\$ 670       |
|  | PS-4120FA           | Frosted             | 41 | ¼  | 20 | 18      | 1.9           | F\$ 892       |
|  | PS-4120HGA          | High Gloss          | 41 | ¾  | 20 | 30      | 2.2           | HG\$ 929      |
|  | PS-4120HGA          | High Gloss Graphite | 41 | ¾  | 20 | 30      | 2.2           | GR\$ 1183     |
|  | PS-4120TB           | Tackboard           | 41 | ⅝  | 20 | 12      | 1.8           | U\$ see below |
|  | 66-4120PS           | TFL                 | 41 | ¾  | 20 | 30      | 2.2           | T\$ 389       |
|  | 65-4120PS           | Veneer              | 41 | ¾  | 20 | 30      | 2.2           | W\$ 645       |
|  | PS-3920FA           | Frosted             | 39 | ¼  | 20 | 18      | 1.8           | F\$ 861       |
|  | PS-3920HGA          | High Gloss          | 39 | ¾  | 20 | 29      | 2.2           | HG\$ 901      |
|  | PS-3920HGA          | High Gloss Graphite | 39 | ¾  | 20 | 29      | 2.2           | GR\$ 1144     |
|  | PS-3920TB           | Tackboard           | 39 | ⅝  | 20 | 11      | 1.8           | U\$ see below |
|  | 66-3920PS           | TFL                 | 39 | ¾  | 20 | 29      | 2.2           | T\$ 376       |
|  | 65-3920PS           | Veneer              | 39 | ¾  | 20 | 29      | 2.2           | W\$ 621       |
| PS-3520FA  | Frosted             | 35                  | ¼  | 20 | 17 | 1.7     | F\$ 826       |               |
| PS-3520HGA   | High Gloss          | 35                  | ¾  | 20 | 29 | 2.2     | HG\$ 865      |               |
| PS-3520HGA   | High Gloss Graphite | 35                  | ¾  | 20 | 29 | 2.2     | GR\$ 1101     |               |
| PS-3520TB  | Tackboard           | 35                  | ⅝  | 20 | 11 | 1.5     | U\$ see below |               |
| 66-3520PS  | TFL                 | 35                  | ¾  | 20 | 28 | 2.1     | T\$ 362       |               |
| 65-3520PS  | Veneer              | 35                  | ¾  | 20 | 28 | 2.1     | W\$ 598       |               |
| PS-3320FA  | Frosted             | 33                  | ¼  | 20 | 17 | 1.6     | F\$ 796       |               |
| PS-3320HGA   | High Gloss          | 33                  | ¾  | 20 | 27 | 2.1     | HG\$ 834      |               |
| PS-3320HGA   | High Gloss Graphite | 33                  | ¾  | 20 | 27 | 2.1     | GR\$ 1063     |               |
| PS-3320TB  | Tackboard           | 33                  | ⅝  | 20 | 10 | 1.5     | U\$ see below |               |
| 66-3320PS  | TFL                 | 33                  | ¾  | 20 | 27 | 2.1     | T\$ 349       |               |
| 65-3320PS  | Veneer              | 33                  | ¾  | 20 | 27 | 2.1     | W\$ 576       |               |
| PS-2920FA  | Frosted             | 29                  | ¼  | 20 | 16 | 1.5     | F\$ 763       |               |
| PS-2920HGA   | High Gloss          | 29                  | ¾  | 20 | 26 | 1.9     | HG\$ 798      |               |
| PS-2920HGA   | High Gloss Graphite | 29                  | ¾  | 20 | 26 | 1.9     | GR\$ 1019     |               |
| PS-2920TB  | Tackboard           | 29                  | ⅝  | 20 | 10 | 1.5     | U\$ see below |               |
| 66-2920PS  | TFL                 | 29                  | ¾  | 20 | 26 | 1.9     | T\$ 335       |               |
| 65-2920PS  | Veneer              | 29                  | ¾  | 20 | 26 | 1.9     | W\$ 552       |               |

**Description**

- Mounts to Surface; Provides Privacy 12" Above Surface and Modesty 7" Below Surface
- Available in Frosted or High Gloss Acrylic, Tackboard, TFL, or Veneer; Must Specify; See [TFL Colors](#) or [Veneer Finish](#), See [High Gloss Acrylic Colors](#), For Upholstery, See Below
- Decorative Hardware on Frosted Acrylic & Tackboards; Must Specify: Aluminum (ALUM) or Chrome (CHRM)
- Great option for Canvas and Gesso Modular Height-Adjustable units

**Tackboards - Must Specify: Model# & Fabric/Grade**

| Model     | Ydg  | COM/Grades<br>1, 2, 3 | Grade<br>4 | Grade<br>5 | Grade<br>6 | Grade<br>7 | Grade<br>8 | Grade<br>9 | Grade<br>10 |
|-----------|------|-----------------------|------------|------------|------------|------------|------------|------------|-------------|
| PS-5720TB | 2.00 | \$ 584                | \$ 844     | \$ 966     | \$ 1090    | \$ 1268    | \$ 1450    | \$ 1666    | \$ 1912     |
| PS-5120TB | 2.00 | \$ 542                | \$ 802     | \$ 924     | \$ 1048    | \$ 1226    | \$ 1408    | \$ 1624    | \$ 1870     |
| PS-4520TB | 1.75 | \$ 482                | \$ 710     | \$ 816     | \$ 925     | \$ 1081    | \$ 1240    | \$ 1429    | \$ 1644     |
| PS-4120TB | 1.50 | \$ 444                | \$ 639     | \$ 731     | \$ 824     | \$ 957     | \$ 1094    | \$ 1256    | \$ 1440     |
| PS-3920TB | 1.50 | \$ 430                | \$ 625     | \$ 717     | \$ 810     | \$ 943     | \$ 1080    | \$ 1242    | \$ 1426     |
| PS-3520TB | 1.50 | \$ 416                | \$ 611     | \$ 703     | \$ 796     | \$ 929     | \$ 1066    | \$ 1228    | \$ 1412     |
| PS-3320TB | 1.25 | \$ 379                | \$ 542     | \$ 618     | \$ 695     | \$ 807     | \$ 920     | \$ 1055    | \$ 1209     |
| PS-2920TB | 1.25 | \$ 359                | \$ 522     | \$ 598     | \$ 675     | \$ 787     | \$ 900     | \$ 1035    | \$ 1189     |

For ordering options, see overview at the beginning of section.

# SCREENS+DIVIDERS

## MULTI-USE SPACE DIVISION

| Item   | Model No.  |                     | W  | D | H  | Ship Wt | Cubic Ft | List Price    |
|--|------------|---------------------|----|---|----|---------|----------|---------------|
| 17" H ABOVE AND BELOW SCREENS<br> | PS-6817FA  | Frosted             | 68 | ¼ | 17 | 14      | 3.3      | F\$ 1122      |
|  | PS-6817HGA | High Gloss          | 68 | ¾ | 17 | 24      | 3.3      | HG\$ 1182     |
|  | PS-6817HGA | High Gloss Graphite | 68 | ¾ | 17 | 24      | 3.3      | GR\$ 1526     |
|  | PS-6817TB  | Tackboard           | 68 | ⅝ | 17 | 15      | 2.5      | U\$ see below |
|  | 66-6817PS  | TFL                 | 68 | ¾ | 17 | 24      | 3.3      | T\$ 450       |
|  | 65-6817PS  | Veneer              | 68 | ¾ | 17 | 24      | 3.3      | W\$ 742       |
|  | PS-6217FA  | Frosted             | 62 | ¼ | 17 | 14      | 3.1      | F\$ 1088      |
|  | PS-6217HGA | High Gloss          | 62 | ¾ | 17 | 22      | 3.1      | HG\$ 1148     |
|  | PS-6217HGA | High Gloss Graphite | 62 | ¾ | 17 | 22      | 3.1      | GR\$ 1482     |
|  | PS-6217TB  | Tackboard           | 62 | ⅝ | 17 | 14      | 2.5      | U\$ see below |
|  | 66-6217PS  | TFL                 | 62 | ¾ | 17 | 22      | 3.1      | T\$ 437       |
|  | 65-6217PS  | Veneer              | 62 | ¾ | 17 | 22      | 3.1      | W\$ 719       |
|  | PS-5617FA  | Frosted             | 56 | ¼ | 17 | 13      | 2.9      | F\$ 1051      |
|  | PS-5617HGA | High Gloss          | 56 | ¾ | 17 | 20      | 2.7      | HG\$ 1107     |
|  | PS-5617HGA | High Gloss Graphite | 56 | ¾ | 17 | 20      | 2.7      | GR\$ 1427     |
|  | PS-5617TB  | Tackboard           | 56 | ⅝ | 17 | 13      | 2.2      | U\$ see below |
|  | 66-5617PS  | TFL                 | 56 | ¾ | 17 | 20      | 2.7      | T\$ 419       |
|  | 65-5617PS  | Veneer              | 56 | ¾ | 17 | 20      | 2.7      | W\$ 695       |
|  | PS-5017FA  | Frosted             | 50 | ¼ | 17 | 13      | 2.7      | F\$ 972       |
|  | PS-5017HGA | High Gloss          | 50 | ¾ | 17 | 18      | 2.5      | HG\$ 1020     |
|  | PS-5017HGA | High Gloss Graphite | 50 | ¾ | 17 | 18      | 2.5      | GR\$ 1309     |
|  | PS-5017TB  | Tackboard           | 50 | ⅝ | 17 | 12      | 2.0      | U\$ see below |
|  | 66-5017PS  | TFL                 | 50 | ¾ | 17 | 18      | 2.5      | T\$ 406       |
|  | 65-5017PS  | Veneer              | 50 | ¾ | 17 | 18      | 2.5      | W\$ 670       |
|  | PS-4417FA  | Frosted             | 44 | ¼ | 17 | 12      | 2.5      | F\$ 895       |
|  | PS-4417HGA | High Gloss          | 44 | ¾ | 17 | 16      | 2.3      | HG\$ 933      |
|  | PS-4417HGA | High Gloss Graphite | 44 | ¾ | 17 | 16      | 2.3      | GR\$ 1188     |
|  | PS-4417TB  | Tackboard           | 44 | ⅝ | 17 | 11      | 1.8      | U\$ see below |
|  | 66-4417PS  | TFL                 | 44 | ¾ | 17 | 16      | 2.3      | T\$ 390       |
|  | 65-4417PS  | Veneer              | 44 | ¾ | 17 | 16      | 2.3      | W\$ 648       |

**Description**

- Mounts to Surface
- Available in Frosted or High Gloss Acrylic, Tackboard, TFL, or Veneer; Must Specify; See [TFL Colors](#) or [Veneer Finish](#), See [High Gloss Acrylic Colors](#), For Upholstery, See Below
- Provides Privacy 12" Above Surface and Modesty 4" Below Surface
- Decorative Attachment Hardware on Frosted Acrylic & Tackboards; Must Specify: Aluminum (ALUM) or Chrome (CHRM)
- Great option for Canvas and Gesso Modular Height-Adjustable units

**Tackboards - Must Specify: Model# & Fabric/Grade**

| Model     | Ydg  | COM/Grades<br>1, 2, 3 | Grade<br>4 | Grade<br>5 | Grade<br>6 | Grade<br>7 | Grade<br>8 | Grade<br>9 | Grade<br>10 |
|-----------|------|-----------------------|------------|------------|------------|------------|------------|------------|-------------|
| PS-6817TB | 2.00 | \$ 602                | \$ 862     | \$ 984     | \$ 1108    | \$ 1286    | \$ 1468    | \$ 1684    | \$ 1930     |
| PS-6217TB | 2.00 | \$ 565                | \$ 825     | \$ 947     | \$ 1071    | \$ 1249    | \$ 1431    | \$ 1647    | \$ 1893     |
| PS-5617TB | 2.00 | \$ 515                | \$ 775     | \$ 897     | \$ 1021    | \$ 1199    | \$ 1381    | \$ 1597    | \$ 1843     |
| PS-5017TB | 2.00 | \$ 487                | \$ 747     | \$ 869     | \$ 993     | \$ 1171    | \$ 1353    | \$ 1569    | \$ 1815     |
| PS-4417TB | 1.75 | \$ 439                | \$ 667     | \$ 773     | \$ 882     | \$ 1038    | \$ 1197    | \$ 1386    | \$ 1601     |

**Pricing Codes:** C=Clear F= Frosted HG= High Gloss GR= High Gloss Graphite U=Tackboard T = TFL W = Veneer

For ordering options, see overview at the beginning of section.

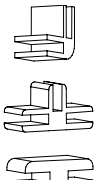
| Item  | Model No.  | W  | D   | H   | Ship Wt | Cubic Ft | List Price |
|---|--|----|-----|-----|---------|----------|------------|
|  | 01-2WAY90  | 1¼ | 1¼  | 7⁄8 | 0.1     | 0.8      | \$ 32      |
|   | <i>For Use with 2-Way, 90° Corner Connections</i>    |    |     |     |         |          |            |
|   | 01-3WAY90  | 2  | 1½  | 7⁄8 | 0.1     | 0.8      | \$ 24      |
|   | <i>For Use with 3-Way, T-Connections</i>             |    |     |     |         |          |            |
|   | 01-2WAY180   | 1⅞ | 7⁄8 | 1⅜  | 0.1     | 0.8      | \$ 19      |
|   | <i>For Use with 2-Way, 180° Straight Connections</i> |    |     |     |         |          |            |

**Description**

- Constructed of Metal with a Chrome Finish
- For Use with ¼" Thick Clear and Frosted Acrylics
- Provides a Clean Connection For Adjacent Panels and Screens
- SIN NEW

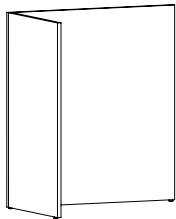
**51" L-GALLERY SCREEN**

| Left Screen   |               | Right Screen |    |    |    |     |      |     |      |  |
|---------------|---------------|--------------|----|----|----|-----|------|-----|------|--|
| 66-4830LGSL51 | 66-4830LGSR51 | TFL          | 48 | 31 | 51 | 110 | 12.5 | T\$ | 1054 |  |
| 65-4830LGSL51 | 65-4830LGSR51 | Veneer       |    |    |    |     |      | W\$ | 1749 |  |
| 66-4824LGSL51 | 66-4824LGSR51 | TFL          | 48 | 25 | 51 | 102 | 12.5 | T\$ | 988  |  |
| 65-4824LGSL51 | 65-4824LGSR51 | Veneer       |    |    |    |     |      | W\$ | 1643 |  |
| 66-3630LGSL51 | 66-3630LGSR51 | TFL          | 36 | 31 | 51 | 94  | 12.5 | T\$ | 951  |  |
| 65-3630LGSL51 | 65-3630LGSR51 | Veneer       |    |    |    |     |      | W\$ | 1580 |  |
| 66-3624LGSL51 | 66-3624LGSR51 | TFL          | 36 | 25 | 51 | 86  | 12.5 | T\$ | 912  |  |
| 65-3624LGSL51 | 65-3624LGSR51 | Veneer       |    |    |    |     |      | W\$ | 1518 |  |

**Description**

- Mounted to End of Desk; Includes Leveling Glides
- Available in TFL and Veneer; Must Specify Finish/Color, [See Color and Finish Options](#)
- Works With 24" and 30" Tops
- Does Not Provide Support

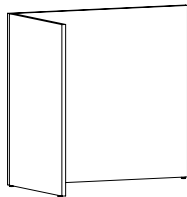
**42" L-GALLERY SCREEN**

| Left Screen   |               | Right Screen |    |    |    |    |      |     |      |  |
|---------------|---------------|--------------|----|----|----|----|------|-----|------|--|
| 66-4830LGSL42 | 66-4830LGSR42 | TFL          | 48 | 31 | 42 | 92 | 12.2 | T\$ | 951  |  |
| 65-4830LGSL42 | 65-4830LGSR42 | Veneer       |    |    |    |    |      | W\$ | 1580 |  |
| 66-4824LGSL42 | 66-4824LGSR42 | TFL          | 48 | 25 | 42 | 85 | 12.2 | T\$ | 909  |  |
| 65-4824LGSL42 | 65-4824LGSR42 | Veneer       |    |    |    |    |      | W\$ | 1514 |  |
| 66-3630LGSL42 | 66-3630LGSR42 | TFL          | 36 | 31 | 42 | 78 | 12.2 | T\$ | 881  |  |
| 65-3630LGSL42 | 65-3630LGSR42 | Veneer       |    |    |    |    |      | W\$ | 1466 |  |
| 66-3624LGSL42 | 66-3624LGSR42 | TFL          | 36 | 25 | 42 | 72 | 12.2 | T\$ | 847  |  |
| 65-3624LGSL42 | 65-3624LGSR42 | Veneer       |    |    |    |    |      | W\$ | 1410 |  |

**Description**

- Mounted to End of Desk; Includes Leveling Glides
- Available in TFL and Veneer; Must Specify Finish/Color, [See Color and Finish Options](#)
- Works With 24" and 30" Tops
- Does Not Provide Support

**Pricing Codes:** T = TFL W = Veneer

For ordering options, see overview at the beginning of section.

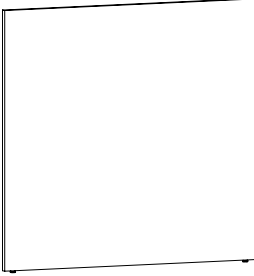
| Item  | Model No. |        | W  | D   | H   | Ship Wt | Cubic Ft | List Price |
|---|-----------|--------|----|-----|-----|---------|----------|------------|
| 51" GALLERY SCREEN<br>STRAIGHT FLOORSTANDING<br> | 66-5173GS | TFL    | 73 | 1   | 51¼ | 110     | 7.9      | T\$ 1148   |
|   | 65-5173GS | Veneer |    |     |     |         |          | W\$ 1910   |
|   | 66-5172GS | TFL    | 72 | 1   | 51¼ | 110     | 7.9      | T\$ 1140   |
|   | 65-5172GS | Veneer |    |     |     |         |          | W\$ 1896   |
|   | 66-5167GS | TFL    | 67 | 1   | 51¼ | 104     | 7.3      | T\$ 1104   |
|   | 65-5167GS | Veneer |    |     |     |         |          | W\$ 1834   |
|   | 66-5166GS | TFL    | 66 | 1   | 51¼ | 104     | 7.3      | T\$ 1097   |
|   | 65-5166GS | Veneer |    |     |     |         |          | W\$ 1822   |
|   | 66-5161GS | TFL    | 61 | 1   | 51¼ | 98      | 6.7      | T\$ 1058   |
|   | 65-5161GS | Veneer |    |     |     |         |          | W\$ 1758   |
|   | 66-5160GS | TFL    | 60 | 1   | 51¼ | 98      | 6.7      | T\$ 1052   |
|   | 65-5160GS | Veneer |    |     |     |         |          | W\$ 1746   |
|   | 66-5155GS | TFL    | 55 | 1   | 51¼ | 92      | 6.1      | T\$ 1011   |
|   | 65-5155GS | Veneer |    |     |     |         |          | W\$ 1681   |
|   | 66-5154GS | TFL    | 54 | 1   | 51¼ | 92      | 6.1      | T\$ 1004   |
|   | 65-5154GS | Veneer |    |     |     |         |          | W\$ 1668   |
|   | 66-5149GS | TFL    | 49 | 1   | 51¼ | 86      | 5.4      | T\$ 965    |
|   | 65-5149GS | Veneer |    |     |     |         |          | W\$ 1605   |
|   | 66-5148GS | TFL    | 48 | 1   | 51¼ | 86      | 5.4      | T\$ 958    |
|   | 65-5148GS | Veneer |    |     |     |         |          | W\$ 1590   |
|   | 66-5143GS | TFL    | 43 | 1   | 51¼ | 80      | 4.7      | T\$ 920    |
|   | 65-5143GS | Veneer |    |     |     |         |          | W\$ 1531   |
|   | 66-5142GS | TFL    | 42 | 1   | 51¼ | 80      | 4.7      | T\$ 914    |
|   | 65-5142GS | Veneer |    |     |     |         |          | W\$ 1519   |
|   | 66-5137GS | TFL    | 37 | 1   | 51¼ | 60      | 4.1      | T\$ 796    |
|   | 65-5137GS | Veneer |    |     |     |         |          | W\$ 1325   |
|   | 66-5136GS | TFL    | 36 | 1   | 51¼ | 60      | 4.1      | T\$ 773    |
|   | 65-5136GS | Veneer |    |     |     |         |          | W\$ 1284   |
|   | 66-5131GS | TFL    | 31 | 1   | 51¼ | 54      | 3.5      | T\$ 724    |
|   | 65-5131GS | Veneer |    |     |     |         |          | W\$ 1204   |
|   | 66-5130GS | TFL    | 30 | 1   | 51¼ | 54      | 3.5      | T\$ 714    |
|   | 65-5130GS | Veneer |    |     |     |         |          | W\$ 1187   |
| 66-5125GS   | TFL       | 25     | 1  | 51¼ | 48  | 2.8     | T\$ 662  |            |
| 65-5125GS   | Veneer    |        |    |     |     |         | W\$ 1100 |            |
| 66-5124GS   | TFL       | 24     | 1  | 51¼ | 48  | 2.8     | T\$ 652  |            |
| 65-5124GS   | Veneer    |        |    |     |     |         | W\$ 1083 |            |
| 66-5119GS   | TFL       | 19     | 1  | 51¼ | 42  | 2.2     | T\$ 614  |            |
| 65-5119GS   | Veneer    |        |    |     |     |         | W\$ 1017 |            |
| 66-5118GS   | TFL       | 18     | 1  | 51¼ | 42  | 2.2     | T\$ 604  |            |
| 65-5118GS   | Veneer    |        |    |     |     |         | W\$ 1004 |            |

**Description**

- Horizontal Woodgrain
- Mounts to Back of Modular Credenza for Space Division
- Available in TFL and Veneer; Must Specify Finish/Color, [See Color and Finish Options](#)
- Extend up to 24" Beyond Workstation without Additional Support
- Includes Leveling Glides
- Six (6) Wire Management Grommet Location Options; Must Specify Location/Color, [See Grommet Locations](#)

**Pricing Codes:** T = TFL W = Veneer

For ordering options, see overview at the beginning of section.

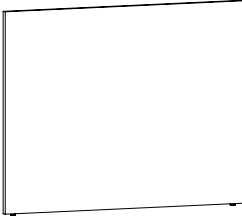
| Item  | Model No. |        | W  | D | H  | Ship Wt | Cubic Ft | List Price |
|---|-----------|--------|----|---|----|---------|----------|------------|
| 42" GALLERY SCREEN<br>STRAIGHT FLOORSTANDING                                      | 66-4273GS | TFL    | 73 | 1 | 42 | 92      | 6.6      | T\$ 996    |
|   | 65-4273GS | Veneer |    |   |    |         |          | W\$ 1656   |
|  | 66-4272GS | TFL    | 72 | 1 | 42 | 92      | 6.6      | T\$ 988    |
|   | 65-4272GS | Veneer |    |   |    |         |          | W\$ 1643   |
|   | 66-4267GS | TFL    | 67 | 1 | 42 | 85      | 6.1      | T\$ 956    |
|   | 65-4267GS | Veneer |    |   |    |         |          | W\$ 1586   |
|   | 66-4266GS | TFL    | 66 | 1 | 42 | 85      | 6.1      | T\$ 948    |
|   | 65-4266GS | Veneer |    |   |    |         |          | W\$ 1575   |
|   | 66-4261GS | TFL    | 61 | 1 | 42 | 78      | 5.5      | T\$ 915    |
|   | 65-4261GS | Veneer |    |   |    |         |          | W\$ 1519   |
|   | 66-4260GS | TFL    | 60 | 1 | 42 | 78      | 5.5      | T\$ 906    |
|   | 65-4260GS | Veneer |    |   |    |         |          | W\$ 1507   |
|   | 66-4255GS | TFL    | 55 | 1 | 42 | 71      | 5.0      | T\$ 872    |
|   | 65-4255GS | Veneer |    |   |    |         |          | W\$ 1447   |
|   | 66-4254GS | TFL    | 54 | 1 | 42 | 71      | 5.0      | T\$ 865    |
|   | 65-4254GS | Veneer |    |   |    |         |          | W\$ 1438   |
|   | 66-4249GS | TFL    | 49 | 1 | 42 | 64      | 4.5      | T\$ 831    |
|   | 65-4249GS | Veneer |    |   |    |         |          | W\$ 1381   |
|   | 66-4248GS | TFL    | 48 | 1 | 42 | 64      | 4.5      | T\$ 824    |
|   | 65-4248GS | Veneer |    |   |    |         |          | W\$ 1369   |
|   | 66-4243GS | TFL    | 43 | 1 | 42 | 57      | 4.0      | T\$ 792    |
|   | 65-4243GS | Veneer |    |   |    |         |          | W\$ 1312   |
|   | 66-4242GS | TFL    | 42 | 1 | 42 | 57      | 4.0      | T\$ 783    |
|   | 65-4242GS | Veneer |    |   |    |         |          | W\$ 1303   |
|   | 66-4237GS | TFL    | 37 | 1 | 42 | 50      | 3.4      | T\$ 745    |
|   | 65-4237GS | Veneer |    |   |    |         |          | W\$ 1235   |
|   | 66-4236GS | TFL    | 36 | 1 | 42 | 50      | 3.4      | T\$ 734    |
|   | 65-4236GS | Veneer |    |   |    |         |          | W\$ 1222   |
|   | 66-4231GS | TFL    | 31 | 1 | 42 | 43      | 2.9      | T\$ 693    |
|   | 65-4231GS | Veneer |    |   |    |         |          | W\$ 1152   |
|   | 66-4230GS | TFL    | 30 | 1 | 42 | 43      | 2.9      | T\$ 684    |
|   | 65-4230GS | Veneer |    |   |    |         |          | W\$ 1137   |
|   | 66-4225GS | TFL    | 25 | 1 | 42 | 36      | 2.3      | T\$ 634    |
|   | 65-4225GS | Veneer |    |   |    |         |          | W\$ 1057   |
|   | 66-4224GS | TFL    | 24 | 1 | 42 | 36      | 2.3      | T\$ 626    |
|   | 65-4224GS | Veneer |    |   |    |         |          | W\$ 1040   |
|   | 66-4219GS | TFL    | 19 | 1 | 42 | 29      | 1.8      | T\$ 595    |
|   | 65-4219GS | Veneer |    |   |    |         |          | W\$ 987    |
|   | 66-4218GS | TFL    | 18 | 1 | 42 | 29      | 1.8      | T\$ 587    |
|   | 65-4218GS | Veneer |    |   |    |         |          | W\$ 975    |

**Description**

- Horizontal Woodgrain
- Mounts to Back of Modular Credenza for Space Division
- Available in TFL and Veneer; Must Specify Finish/Color, [See Color and Finish Options](#)
- Extend up to 24" Beyond Workstation without Additional Support
- Includes Leveling Glides
- Six (6) Wire Management Grommet Location Options; Must Specify Location/Color, [See Grommet Locations](#)

**Pricing Codes:** T = TFL W = Veneer

For ordering options, see overview at the beginning of section.

| Item  | Model No. |        | W  | D | H  | Ship Wt | Cubic Ft | List Price |
|---|-----------|--------|----|---|----|---------|----------|------------|
| 30" GALLERY SCREEN<br>STRAIGHT FLOORSTANDING                                      | 66-3073GS | TFL    | 73 | 1 | 30 | 68      | 4.8      | T\$ 902    |
|   | 65-3073GS | Veneer |    |   |    |         |          | W\$ 1498   |
|  | 66-3072GS | TFL    | 72 | 1 | 30 | 68      | 4.8      | T\$ 896    |
|   | 65-3072GS | Veneer |    |   |    |         |          | W\$ 1488   |
|   | 66-3067GS | TFL    | 67 | 1 | 30 | 64      | 4.4      | T\$ 866    |
|   | 65-3067GS | Veneer |    |   |    |         |          | W\$ 1441   |
|   | 66-3066GS | TFL    | 66 | 1 | 30 | 64      | 4.4      | T\$ 861    |
|   | 65-3066GS | Veneer |    |   |    |         |          | W\$ 1431   |
|   | 66-3061GS | TFL    | 61 | 1 | 30 | 60      | 4.0      | T\$ 831    |
|   | 65-3061GS | Veneer |    |   |    |         |          | W\$ 1382   |
|   | 66-3060GS | TFL    | 60 | 1 | 30 | 60      | 4.0      | T\$ 825    |
|   | 65-3060GS | Veneer |    |   |    |         |          | W\$ 1373   |
|   | 66-3055GS | TFL    | 55 | 1 | 30 | 56      | 3.6      | T\$ 796    |
|   | 65-3055GS | Veneer |    |   |    |         |          | W\$ 1325   |
|   | 66-3054GS | TFL    | 54 | 1 | 30 | 56      | 3.6      | T\$ 792    |
|   | 65-3054GS | Veneer |    |   |    |         |          | W\$ 1315   |
|   | 66-3049GS | TFL    | 49 | 1 | 30 | 52      | 3.2      | T\$ 761    |
|   | 65-3049GS | Veneer |    |   |    |         |          | W\$ 1264   |
|   | 66-3048GS | TFL    | 48 | 1 | 30 | 52      | 3.2      | T\$ 755    |
|   | 65-3048GS | Veneer |    |   |    |         |          | W\$ 1255   |
|   | 66-3043GS | TFL    | 43 | 1 | 30 | 48      | 2.9      | T\$ 726    |
|   | 65-3043GS | Veneer |    |   |    |         |          | W\$ 1207   |
|   | 66-3042GS | TFL    | 42 | 1 | 30 | 48      | 2.9      | T\$ 720    |
|   | 65-3042GS | Veneer |    |   |    |         |          | W\$ 1199   |
|   | 66-3037GS | TFL    | 37 | 1 | 30 | 41      | 2.5      | T\$ 671    |
|   | 65-3037GS | Veneer |    |   |    |         |          | W\$ 1113   |
|   | 66-3036GS | TFL    | 36 | 1 | 30 | 41      | 2.5      | T\$ 661    |
|   | 65-3036GS | Veneer |    |   |    |         |          | W\$ 1097   |
|   | 66-3031GS | TFL    | 31 | 1 | 30 | 35      | 2.1      | T\$ 629    |
|   | 65-3031GS | Veneer |    |   |    |         |          | W\$ 1052   |
|   | 66-3030GS | TFL    | 30 | 1 | 30 | 35      | 2.1      | T\$ 624    |
|   | 65-3030GS | Veneer |    |   |    |         |          | W\$ 1039   |
|   | 66-3025GS | TFL    | 25 | 1 | 30 | 28      | 1.7      | T\$ 600    |
|   | 65-3025GS | Veneer |    |   |    |         |          | W\$ 1001   |
|   | 66-3024GS | TFL    | 24 | 1 | 30 | 28      | 1.7      | T\$ 596    |
|   | 65-3024GS | Veneer |    |   |    |         |          | W\$ 990    |
|   | 66-3019GS | TFL    | 19 | 1 | 30 | 21      | 1.3      | T\$ 542    |
|   | 65-3019GS | Veneer |    |   |    |         |          | W\$ 901    |
|   | 66-3018GS | TFL    | 18 | 1 | 30 | 21      | 1.3      | T\$ 529    |
|   | 65-3018GS | Veneer |    |   |    |         |          | W\$ 881    |

**Description**

- Horizontal Woodgrain
- Mounts to Back of Modular Credenza for Space Division
- Available in TFL and Veneer; Must Specify Finish/Color, [See Color and Finish Options](#)
- Extend up to 24" Beyond Workstation without Additional Support
- Three (3) Wire Management Grommet Location Options; Must Specify Location/Color, [See Grommet Locations](#)

**Pricing Codes:** T = TFL W = Veneer

For ordering options, see overview at the beginning of section.



### STEP 1: PLANNING FOR SQUARE ONE

Planning for Square One is based on configuring 12"x24" and 24"x24" blocks in nearly any manner to create space dividing walls, coves, work zones, and more within open environments.

#### Idea Starters/Typicals:

When you select one of our pre-configured Typicals, everything you need comes specified together, including the blocks, caps and posts, hardware, glides, and more.

- Select the typical number (e.g., 17-4), then specify the finish and hardware color.
- Add optional accessories (see Step #5).

#### Make Your Own Typicals:

There are endless opportunities with Square One, giving you the ability to create unique setups to meet the specific needs of your customers.

- We recommend utilizing our Specification/Drawing Services team, who can help in bringing your vision to life and ensure all the necessary components are included. To get started, just send us a drawing. You can use our easy online request form at: [www.indianafurniture.com/contact/design-services-request-form](http://www.indianafurniture.com/contact/design-services-request-form)
- Steps #2 - #5 outline the process for specifying your own typical. Please provide a drawing with the order to ensure accuracy.

### STEP 2: SPECIFYING BLOCKS

When making your own typical, choose the quantity of blocks needed to create your design. We offer single blocks in two styles: 24"x24" and 12"x24".

- Blocks can go up to four high (8') and do runs of five wide (10') without a supporting wall or anchor to create stability.
- We recommend using single 12" x 24" blocks on the top or ends. If placing on the bottom or in the center of the design, using two of them together will ensure alignment with the holes bored on attachment items like End Caps, Corner Posts, etc.
- When creating an "L" or "T" design, we suggest going a minimum of three blocks wide to ensure stability without additional support.

### STEP 3: CAPS, POSTS, CONNECTORS, AND SPANNERS

Next, determine what Caps, Posts, Connectors, and Spanners are needed to complete the design.

- End and Top Caps are necessary to ensure a clean and balanced aesthetic (as they hide the attachment hardware/ensure no empty holes are showing where attachments would have been).
- Square One offers connection beams to create 90° turns (Corner Posts), three walls (T-Connectors), four walls (X-Connectors), and span doorways or other openings (Horizontal Beam Spanners).
- End Caps, Posts, and Connectors should always be specified to run longer (taller) than the unit so that the end of the top cap or horizontal rail will not be seen (there are only a few exceptions).

### STEP 4: HARDWARE, LEVELING, AND GENERAL ASSEMBLY

Whether connecting square to square or square to post, individual components come with the necessary hardware. Should you need more, we offer separate Bolt Kits to provide proper installation.

We offer heavy-duty, adjustable leveling glides to compensate for uneven floors. A tool (6mm allen driver bit) is also available to insert the glide nuts. The glides must be ordered separately from the blocks.

We do not offer connection methods to anchor to the floor or wall. We recommend discussing this with the building's facility manager for proper connection. Indiana Furniture will not be liable for wall or floor mounts that are not properly installed.

Assembly Instructions may be found on our website.

### STEP 5: ACCESSORIES

Add function without sacrificing beauty. Acrylic Inserts, Tackable and Acoustical Panels, Dry Erase Boards, and TV mounts can give your space the ability for more privacy, collaboration, or brainstorming.

- Dry Erase Boards and Tackable Panels have onset installation.
- Dry Erase Boards can be mounted either vertically or horizontally.
- Acoustical Panels are either specified onset or inset, and Acrylic Inserts are inset.
- Tackable Panels are fully upholstered, so a clean aesthetic is seen from both sides of the blocks.
- Acrylic Inserts lock into insert retainers which are installed on top of the hardware, inside of the block, allowing for a quick and tight-fitting installation.
- Frosted Acrylic Inserts can be customized with a logo or image, giving you freedom to create a personal touch. Provide a .CDR, .AI, or .EPS file. Extended lead times may apply.
- We offer the Vesta Power Data Center and other similar items to add power within your Square One spaces created.



**Space Division.  
Redefined.**



17-1 (Approximately 10' X 10' X 8')



17-2 (Approximately 8' X 8' X 8')



17-3 (Approximately 12' X 8' X 8')



17-4 (Approximately 10' X 8' X 8')

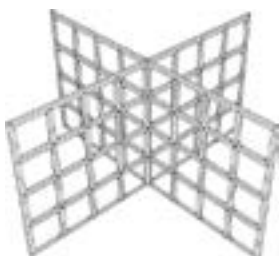

17-5 (Approximately 16' X 16' X 8')



17-6 (Approximately 8' X 8' X 8')



17-7 (Approximately 8' X 8')



17-8 (Approximately 12' X 8' X 8')

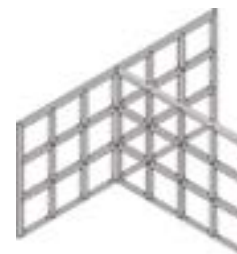

17-9 (Approximately 12' X 8' X 6')



17-10 (Approximately 4' X 8' X 8')



17-11 (Approximately 4' X 4' X 8')



17-12 (Approximately 2' X 4' X 8')



17-13 (Approximately 8' X 8' X 8')

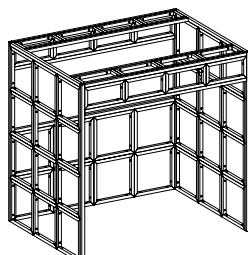

17-14 (Approximately 8' X 6' X 8')

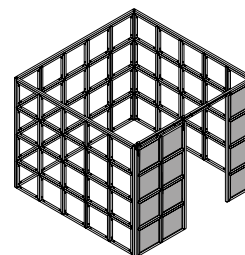

17-15 (Approximately 10' X 10' X 8')

Space Division. Redefined.

Square One is the clean, simple way to provide space division, functionality, and architectural design to any zone within the working environment. With individual building blocks that securely connect to one another and accessories like dry erase boards, barn doors, planter boxes, acrylic inserts, and tackable and acoustical panels, your personalization of Square One is only limited to your imagination. Square One is made of solid wood, providing a sustainable material for the workplace and bringing warmth and beauty to any space.

## CONSTRUCTION

### BLOCKS

- Blocks are manufactured using kiln-dried, solid European Beech and are attached using hardware, available in your choice of nickel or black, for durability and strength

### FINISH

- Indiana Furniture uses a multi-step hand finishing process
- Blocks are pre-sanded for smoothness, then stained and finished with a catalyzed varnish finish which offers durability, lasting beauty, and resistance to normal wear
- Square One finishes were selected to complement casegoods, tables, and seating finishes which allows for easy blending of furniture components

### END & TOP CAPS

- Measure 1¾"W and 1¾"D and come in a variety of lengths
- Used vertically and horizontally to provide a clean, balanced aesthetic by hiding the attachment hardware
- Caps are constructed of kiln-dried, solid European Beech and include blind threaded inserts for installation

### CORNER POSTS

- Measure 1¾"W and 1¾"D and come in a variety of heights
- Used to create 90° turns
- Corner posts are constructed of kiln-dried, solid European Beech and include blind threaded inserts for installation

### T-CONNECTORS

- Measure 1¾"W and 1¾"D and come in a variety of heights
- Used vertically and horizontally to create an intersection for three wall runs
- T-Connectors are constructed of kiln-dried, solid European Beech and include blind threaded inserts for installation

### X-CONNECTORS

- Measure 1¾"W and 1¾"D and come in a variety of heights
- Used vertically to create an intersection for four wall runs
- X-Connectors are constructed of kiln-dried, solid European Beech and include blind threaded inserts for installation

### HORIZONTAL BEAM SPANNERS

- Measure 1¾"D and 1¾"H and come in a variety of widths
- Used horizontally to provide structural support for doorways and other designed openings
- Spanners are constructed of kiln-dried, solid European Beech and include blind threaded inserts for installation

### DRY ERASE BOARDS

- Available in 22½" or 46½" heights and multiple widths
- Installed onset, either vertically or horizontally
- Installation brackets are included; longer bolts for installation on-site are also included

### ACOUSTICAL PANELS

- Constructed of 100% polyester made from up to 50% recycled materials without the use of adhesive or other bonding agents, Acoustical Panels are 100% recyclable
- Panels are ½" (12mm) thick and are available in multiple widths and lengths
- Sound absorption is average NRC 0.75 (50mm air gap) 1.0 NRC in mid-high frequencies
- Panels are installed inset with tabs or onset with dual-lock connectors

### TACKABLE PANELS

- Tackable Panels are constructed of 7/16" corkboard and then covered, on both sides, in the textile of your choice
- Highly-skilled upholsterers hand tailor each unit to meet individual specifications
- Upholstery options include a broad range of styles, all pre-graded in this price list for ease of use
- Panels are installed onset with dual-lock connectors

### ACRYLIC INSERTS

- Acrylic inserts are manufactured using high performance engineering resins and provide translucency, strength, clarity, and versatility
- Inserts are 20½"W and are available in 8½" and 20½" lengths
- Inserts are inset within the blocks with retainers for a tight-fitting installation
- Frosted acrylic options can be customized with logos and other designs as requested

### LEVELING GLIDES

- Heavy-duty, adjustable leveling glides are available in black or nickel and are recommended to ensure proper leveling and compensation for uneven floors
- A tool (6mm allen driver bit) to install glides is also available to ensure proper installation

### BARN DOOR HARDWARE

- Sliding system tracks are constructed of black powder coated steel
- Hardware includes tracks, hangers, track stops, screws, inserts, bracket, and sliding system
- Installation hardware will be shipped attached to components

### PLANTER BOXES

- The planter box is made of ¾" thick thermally-fused laminate (TFL) fused particle-board core
- Grain direction runs horizontal
- Planter boxes are fastened together with screws and heavy-duty metal fasteners
- Optional insert is made of lightweight, fade-resistant, recyclable plastic

### HOW TO ORDER EXAMPLES

#### IDEA STARTERS/TYPICALS

| Model No. | Description              | Example   |
|-----------|--------------------------|-----------|
| 17-1      | Finish<br>Hardware Color | EG<br>BLK |

#### BLOCKS & RAILS

| Model No. | Description              | Example    |
|-----------|--------------------------|------------|
| 17-2424BL | Finish<br>Hardware Color | NB<br>NCKL |

#### ACRYLIC INSERTS

| Model No. | Description   | Example |
|-----------|---------------|---------|
| AI-2020AC | Acrylic Color | FSTA    |

#### PLANTER BOXES

| Model No. | Description                                    | Example          |
|-----------|--|------------------|
| 01-1909PL | TFL Color<br>Hardware Color<br>Optional Insert | AS<br>BLK<br>PBI |

### veneer (W) OPTIONS

Indiana Furniture uses a multi-step, hand finishing process on all exposed wood frames.

Square One models feature a catalyzed varnish finish which offers durability, lasting beauty, and resistance to normal wear.

|     |               |    |              |
|-----|---------------|----|--------------|
| AWH | Aspen White   | OR | Orchard      |
| EG  | Ember Gray    | TR | Truffle Rain |
| NB  | Natural Beech |    |              |

### TFL (T) LAMINATE OPTIONS ON TABLES

#### WOODGRAIN

|     |                  |     |                     |
|-----|------------------|-----|---------------------|
| AS  | Asian Night      | PNW | Pinnacle Walnut     |
| BW  | Beigewood        | SCH | Select Cherry       |
| CO  | Columbian Walnut | SKC | Shaker Cherry       |
| EF  | Espresso         | SBP | Smoky Brown Pear    |
| GC  | Golden Cherry    | TK  | Studio Teak         |
| HVM | Harvest Maple    | SM  | Sugar Maple         |
| MW  | Mahogany Walnut  | WTA | Weathered Ash       |
| ORW | Oak Riftwood     | WC  | Williamsburg Cherry |

#### SOLID

|     |                |     |            |
|-----|----------------|-----|------------|
| BL  | Black          | PPD | Pepperdust |
| WH  | Designer White | SG  | Slate Grey |
| FHG | Fashion Grey   | WHS | White Sand |

### HARDWARE/LEVELING GLIDES COLOR OPTIONS

|     |       |      |        |
|-----|-------|------|--------|
| BLK | Black | NCKL | Nickel |
|-----|-------|------|--------|

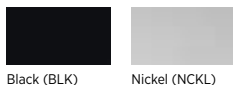

### ACOUSTICAL PANEL OPTIONS

|     |       |     |       |
|-----|-------|-----|-------|
| ASH | Ash   | MLK | Milky |
| BLK | Black | TPE | Taupe |
| GRY | Grey  |     |       |



### ACRYLIC INSERT OPTIONS

|      |         |      |          |
|------|---------|------|----------|
| FSTA | Frosted | TGWA | Twigwork |
| RAFA | Raffia  | TNSA | Tinsel   |
| WOVA | Woven   |      |          |



### TACKABLE PANEL OPTIONS

Available in single upholstery in a wide variety of graded-in or contract options.

### CERTIFICATIONS & COMPLIANCE

- CAL 117-2013 Compliance
- Intertek Sustainability Certified
- BIFMA level® Certified
- BIFMA Compliant® Certified
- TSCA Title VI (CARB) Compliance
- US Green Building's LEED® Contribution

### Building Blocks

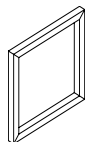

24"x24" Block  
[\(See Details\)](#)

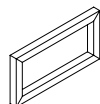

24"x12" Block  
[\(See Details\)](#)

### Hardware

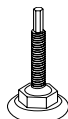

Leveling Glide Kits  
[\(See Details\)](#)

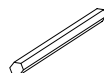

Allen Driver Bit  
[\(See Details\)](#)

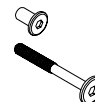

Bolt & Nut Kits  
[\(See Details\)](#)

### Connectors

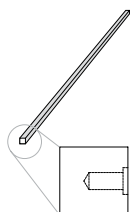

End Caps  
[\(See Details\)](#)

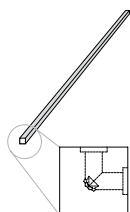

Corner Posts  
[\(See Details\)](#)

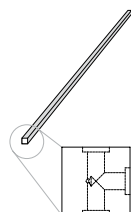

T-Connector Beams  
[\(See Details\)](#)

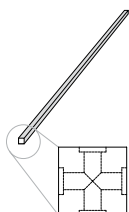

X-Connector Beams  
[\(See Details\)](#)

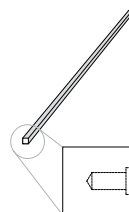

Horizontal Beam Spanners  
[\(See Details\)](#)

### Accessories

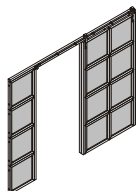

Barn Door Wall  
[\(See Details\)](#)

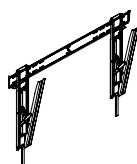

TV Mounts  
[\(See Details\)](#)

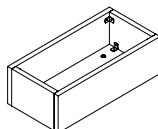

Planter Boxes  
[\(See Details\)](#)



Tic-Tac-Toe Foam Game  
[\(See Details\)](#)



Vesta Power Center  
[\(See Details\)](#)

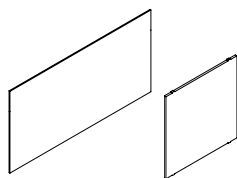

Onset & Inset Acoustical Panels  
[\(See Details\)](#)

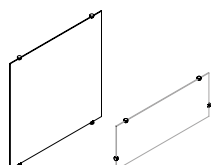





Acrylic Inset Panels  
[\(See Details\)](#)

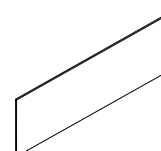



Dry Erase Boards  
[\(See Details\)](#)



Tackable Panels  
[\(See Details\)](#)



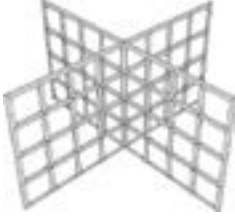

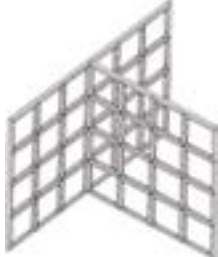
| Item  | Model No.    | Qty | Description   | List Price |
|---|--------------|-----|---|------------|
| <b>HUDDLE</b><br>(APPROXIMATELY 10' X 10' X 8')                                     | 17-1_1701    |     |   | \$ 20688   |
|    |              |     |   |            |
| <b>Consists of:</b>   |              |     |   |            |
|   | 17-2424BL    | 56  | Single Block, 24" x 24"                               | \$ 15456   |
|   | 17-17596EC   | 4   | End Cap, 96" (used vertically)                        | \$ 1480    |
|   | 17-175120EC  | 2   | End Cap, 120" (used horizontally)                     | \$ 806     |
|   | 17-17597CP   | 4   | Corner Post, 97¾"                                     | \$ 1492    |
|   | 17-175120HBS | 2   | Horizontal Beam Spanner, 120"                         | \$ 768     |
|   | 17-LEVKIT    | 14  | Leveler Kit, (2) Levelers                             | \$ 686     |
| <b>HUDDLE</b><br>(APPROXIMATELY 8' X 8' X 8')                                       | 17-2         |     |   | \$ 18254   |
|    |              |     |   |            |
| <b>Consists of:</b>   |              |     |   |            |
|   | 17-2424BL    | 48  | Single Block, 24" x 24"                               | \$ 13248   |
|   | 17-17596EC   | 6   | End Cap, 96" (4 used vertically, 2 used horizontally) | \$ 2220    |
|   | 17-17597CP   | 4   | Corner Post, 97¾"                                     | \$ 1492    |
|   | 17-17596HBS  | 2   | Horizontal Beam Spanner, 96"                          | \$ 706     |
|   | 17-LEVKIT    | 12  | Leveler Kit, (2) Levelers                             | \$ 588     |
| <b>HUDDLE</b><br>(APPROXIMATELY 12' X 8' X 8')                                      | 17-3         |     |   | \$ 18316   |
|  |              |     |   |            |
| <b>Consists of:</b>   |              |     |   |            |
|   | 17-2424BL    | 48  | Single Block, 24" x 24"                               | \$ 13248   |
|   | 17-17596EC   | 4   | End Cap, 96" (2 used vertically, 2 used horizontally) | \$ 1480    |
|   | 17-17597EC   | 2   | End Cap, 97¾" (used vertically)                       | \$ 740     |
|   | 17-17596CP   | 2   | Corner Post, 96"                                      | \$ 746     |
|   | 17-17597CP   | 2   | Corner Post, 97¾"                                     | \$ 746     |
|   | 17-175120HBS | 2   | Horizontal Beam Spanner, 120"                         | \$ 768     |
|   | 17-LEVKIT    | 12  | Leveler Kit, (2) Levelers                             | \$ 588     |
| <b>H-CONFIGURATION</b><br>(APPROXIMATELY 10' X 8' X 8')                             | 17-4         |     |   | \$ 18316   |
|  |              |     |   |            |
| <b>Consists of:</b>   |              |     |   |            |
|   | 17-2424BL    | 48  | Single Block, 24" x 24"                               | \$ 13248   |
|   | 17-17596EC   | 2   | End Cap, 96" (used horizontally)                      | \$ 740     |
|   | 17-17597EC   | 4   | End Cap, 97¾" (used vertically)                       | \$ 1480    |
|   | 17-17596CP   | 4   | Corner Post, 96"                                      | \$ 1492    |
|   | 17-175120HBS | 2   | Horizontal Beam Spanner, 120"                         | \$ 768     |
|   | 17-LEVKIT    | 12  | Leveler Kit, (2) Levelers                             | \$ 588     |

For ordering options, see overview at the beginning of this section.

| Item  | Model No.  | Qty | Description  | List Price |
|---|--|-----|--|------------|
| <b>QUAD-CONFIGURATION</b><br>(APPROXIMATELY 16' X 16' X 8')                         | 17-5   |     |  | \$ 21787   |
|    | <b>Consists of:</b>  |     |  |            |
|   | 17-2424BL  | 64  | Single Block, 24" x 24"                                | \$ 17664   |
|   | 17-17596EC   | 4   | End Cap, 96" (used horizontally)                       | \$ 1480    |
|   | 17-17597EC   | 4   | End Cap, 97¾" (used vertically)                        | \$ 1480    |
|   | 17-17597XB   | 1   | X-Connector Beam, 97¾"                                 | \$ 379     |
|   | 17-LEVKIT  | 16  | Leveler Kit, (2) Levelers                              | \$ 784     |
| <b>WALL COVE</b><br>(APPROXIMATELY 8' X 8' X 8')                                    | 17-6   |     |  | \$ 9819    |
|    | <b>Consists of:</b>  |     |  |            |
|   | 17-2424BL  | 24  | Single Block, 24" x 24"                                | \$ 6624    |
|   | 17-17596EC   | 3   | End Cap, 96" (used horizontally)                       | \$ 1110    |
|   | 17-17597EC   | 4   | End Cap, 97¾" (2 used vertically, 2 used horizontally) | \$ 1480    |
|   | 17-17596CP   | 1   | Corner Post, 96" (used horizontally)                   | \$ 373     |
|   | 17-LEVKIT  | 4   | Leveler Kit, (2) Levelers                              | \$ 196     |
|   | 17-12MMBOLTKIT   | 1   | 12mm Bolt Kit, qty 8                                   | \$ 36      |
|   | <i>* This typcial is not design for freestanding applications. This unit must be secured at the top to a rigid structure. Attachement hardware not included.</i> |     |  |            |
| <b>SINGLE WALL</b><br>(APPROXIMATELY 8' X 8')                                       | 17-7   |     |  | \$ 5722    |
|  | <b>Consists of:</b>  |     |  |            |
|   | 17-2424BL  | 16  | Single Block, 24" x 24"                                | \$ 4416    |
|   | 17-17596EC   | 1   | End Cap, 96" (used horizontally)                       | \$ 370     |
|   | 17-17597EC   | 2   | End Cap, 97¾" (used vertically)                        | \$ 740     |
|   | 17-LEVKIT  | 4   | Leveler Kit, (2) Levelers                              | \$ 196     |
|   | <i>* This typcial is not design for freestanding applications. This unit must be secured at the top to a rigid structure. Attachement hardware not included.</i> |     |  |            |
| <b>T-CONFIGURATION</b><br>(APPROXIMATELY 12' X 8' X 8')                             | 17-8_1708  |     |  | \$ 14102   |
|  | <b>Consists of:</b>  |     |  |            |
|   | 17-2424BL  | 40  | Single Block, 24" x 24"                                | \$ 11040   |
|   | 17-17572EC   | 2   | End Cap, 72" (used horizontally)                       | \$ 716     |
|   | 17-17596EC   | 1   | End Cap, 96" (used horizontally)                       | \$ 370     |
|   | 17-17597EC   | 3   | End Cap, 97¾" (used vertically)                        | \$ 1110    |
|   | 17-17597TCB  | 1   | T-Connector Beam, 97¾"                                 | \$ 376     |
|   | 17-LEVKIT  | 10  | Leveler Kit, (2) Levelers                              | \$ 490     |

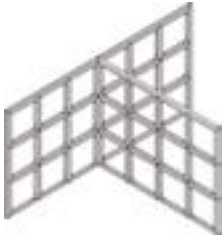
For ordering options, see overview at the beginning of this section.



| Item  | Model No.           | Qty | Description                          | List Price |
|---|---------------------|-----|--------------------------------------|------------|
| T-CONFIGURATION<br>(APPROXIMATELY 12' X 8' X 6')                                    | 17-9                |     |                                      | \$ 11294   |
|    | <b>Consists of:</b> |     |                                      |            |
|   | 17-2424BL           | 30  | Single Block, 24" x 24"              | \$ 8280    |
|   | 17-17572EC          | 2   | End Cap, 72" (used horizontally)     | \$ 716     |
|   | 17-17573EC          | 3   | End Cap, 73¾" (used vertically)      | \$ 1074    |
|   | 17-17596EC          | 1   | End Cap, 96" (used horizontally)     | \$ 370     |
|   | 17-17573TCB         | 1   | T-Connector Beam, 73¾"               | \$ 364     |
|   | 17-LEVKIT           | 10  | Leveler Kit, (2) Levelers            | \$ 490     |
| OFFSET DUAL BOOTH<br>(APPROXIMATELY 4' X 8' X 8')                                   | 17-10               |     |                                      | \$ 14652   |
|    | <b>Consists of:</b> |     |                                      |            |
|   | 17-2424BL           | 36  | Single Block, 24" x 24"              | \$ 9936    |
|   | 17-17548EC          | 2   | End Cap, 48" (used horizontally)     | \$ 590     |
|   | 17-17597EC          | 4   | End Cap, 97¾" (used vertically)      | \$ 1480    |
|   | 17-17524CP          | 2   | Corner Post, 24" (used horizontally) | \$ 574     |
|   | 17-17548CP          | 2   | Corner Post, 48" (used horizontally) | \$ 594     |
|   | 17-17548TCB         | 1   | T-Connector Beam, 48"                | \$ 298     |
|   | 17-17596TCB         | 2   | T-Connector Beam, 96"                | \$ 752     |
|   | 17-LEVKIT           | 8   | Leveler Kit, (2) Levelers            | \$ 392     |
|   | 17-12MMBOLTKIT      | 1   | 12mm Bolt Kit, qty 8                 | \$ 36      |
| DUAL BOOTH<br>(APPROXIMATELY 4' X 4' X 8')  | 17-11_1711          |     |                                      | \$ 10581   |
|  | <b>Consists of:</b> |     |                                      |            |
|   | 17-2424BL           | 24  | Single Block, 24" x 24"              | \$ 6624    |
|   | 17-17524EC1711      | 4   | End Cap, 24" (used horizontally)     | \$ 1136    |
|   | 17-17548EC1711      | 1   | End Cap, 48" (used horizontally)     | \$ 295     |
|   | 17-17597EC1711      | 4   | End Cap, 97¾" (used vertically)      | \$ 1480    |
|   | 17-17597TCB1711     | 2   | T-Connector Beam, 97¾"               | \$ 752     |
|   | 17-LEVKIT           | 6   | Leveler Kit, (2) Levelers            | \$ 294     |
| L COVE<br>(APPROXIMATELY 2' X 4' X 8')  | 17-12_1712          |     |                                      | \$ 5151    |
|  | <b>Consists of:</b> |     |                                      |            |
|   | 17-2424BL           | 12  | Single Block, 24" x 24"              | \$ 3312    |
|   | 17-17524EC          | 1   | End Cap, 24" (used horizontally)     | \$ 284     |
|   | 17-17548EC          | 1   | End Cap, 48" (used horizontally)     | \$ 295     |
|   | 17-17597EC          | 2   | End Cap, 97¾" (used vertically)      | \$ 740     |
|   | 17-17597CP          | 1   | Corner Post, 97¾"                    | \$ 373     |
|   | 17-LEVKIT           | 3   | Leveler Kit, (2) Levelers            | \$ 147     |

For ordering options, see overview at the beginning of this section.



| Item  | Model No.  | Qty | Description | List Price |
|---|------------|-----|-------------|------------|
| C-CONFIGURATION<br>(APPROXIMATELY 8' X 8' X 8') | 17-13_1713 |     |             | \$ 16432   |

**Consists of:**

|            |    |                                  |          |
|------------|----|----------------------------------|----------|
| 17-2424BL  | 48 | Single Block, 24" x 24"          | \$ 13248 |
| 17-17596EC | 3  | End Cap, 96" (used horizontally) | \$ 1110  |
| 17-17597EC | 2  | End Cap, 97¾" (used vertically)  | \$ 740   |
| 17-17597CP | 2  | Corner Post, 97¾"                | \$ 746   |
| 17-LEVKIT  | 12 | Leveler Kit, (2) Levelers        | \$ 588   |

GATEWAY COVE  
(APPROXIMATELY 8' X 6' X 8')

|            |  |  |          |
|------------|--|--|----------|
| 17-14_1714 |  |  | \$ 18098 |
|------------|--|--|----------|

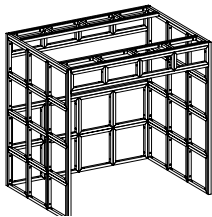
**Consists of:**

|                |    |                                      |         |
|----------------|----|--------------------------------------|---------|
| 17-2424BL      | 32 | Single Block, 24" x 24"              | \$ 8832 |
| 17-2412BL      | 16 | Single Block, 24" x 12"              | \$ 3856 |
| 17-17596EC     | 5  | End Cap, 96" (used horizontally)     | \$ 1850 |
| 17-17572CP     | 2  | Corner Post, 72" (used horizontally) | \$ 724  |
| 17-17596CP     | 2  | Corner Post, 96" (used horizontally) | \$ 746  |
| 17-17597CP     | 4  | Corner Post, 97¾" (used vertically)  | \$ 1492 |
| 17-LEVKIT      | 10 | Leveler Kit, (2) Levelers            | \$ 490  |
| 17-12MMBOLTKIT | 3  | 12mm Bolt Kit, qty 8                 | \$ 108  |

MEETING ROOM WITH BARN DOOR  
(APPROXIMATELY 10' X 10' X 8')

|            |  |  |          |
|------------|--|--|----------|
| 17-15_1715 |  |  | \$ 28884 |
|------------|--|--|----------|

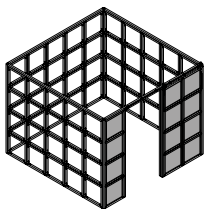
**Consists of:**

|             |    |                                   |          |
|-------------|----|-----------------------------------|----------|
| 17-2424BL   | 60 | Single Block, 24" x 24"           | \$ 16560 |
| 17-175120EC | 3  | End Cap, 120" (used horizontally) | \$ 1209  |
| 17-17597CP  | 4  | Corner Post, 97¾"                 | \$ 1492  |
| 17-4896BDBR | 1  | Barn Door Wall, Right             | \$ 8888  |
| 17-LEVKIT   | 15 | Leveler Kit, (2) Levelers         | \$ 735   |

*\* Must Specify Acrylic and/or Acoustical Inserts for Use in Barn Door Wall (Total 20 Inserts);  
Note: List Price Shown Above Does NOT Include These Required Inserts Due to Variance in Pricing. See  
Page 307 for Acrylic and Acoustical Insert options.*

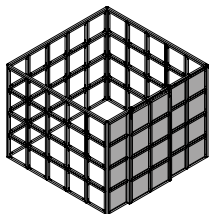

Shown as Right Barn Door

For ordering options, see overview at the beginning of this section.

| Item                      | Model No. | W  | D  | H  | Ship Wt | Cubic Ft | List Price |
|---------------------------|-----------|----|----|----|---------|----------|------------|
| SINGLE BLOCK<br>24" X 24" | 17-2424BL | 24 | 1¾ | 24 | 12      | 1.5      | \$ 276     |

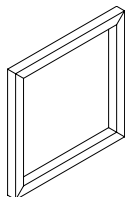

#### Description

- Includes Four (4) Bolts and Nuts for Installation

#### Must Specify (in this order):

Model # and Quantity  
Finish  
Hardware Color

|                           |           |    |    |    |   |     |        |
|---------------------------|-----------|----|----|----|---|-----|--------|
| SINGLE BLOCK<br>24" X 12" | 17-2412BL | 24 | 1¾ | 12 | 8 | 1.0 | \$ 241 |
|---------------------------|-----------|----|----|----|---|-----|--------|

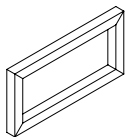

#### Description

- Includes Three (3) Bolts and Nuts for Installation
- Can Be Used Vertically or Horizontally
- Recommended for Use on Top or End of Configuration, Unless Used in Pairs
- We Recommend Using Single 12" x 24" Blocks on the Top or Ends. If Placing on the Bottom or In the Center of the Design, Using Two of Them Together Will Ensure Alignment with the Holes Bored on Attachment Items Like End Caps, Corner Posts, Etc.

#### Must Specify (in this order):

Model # and Quantity  
Finish  
Hardware Color

For ordering options, see overview at the beginning of this section.

| Item     | Model No.                              | W  | D  | H   | Ship Wt | Cubic Ft | List Price |
|----------|--|----|----|-----|---------|----------|------------|
| END CAPS | 17-175120EC                            | 1¾ | 1¾ | 120 | 14      | 0.3      | \$ 403     |
|          | 17-175108EC                            | 1¾ | 1¾ | 108 | 13      | 0.3      | \$ 401     |
|          | 17-17597EC<br><i>Vertical Use Only</i> | 1¾ | 1¾ | 97¾ | 13      | 0.3      | \$ 370     |
|          | 17-17596EC                             | 1¾ | 1¾ | 96  | 12      | 0.3      | \$ 370     |
|          | 17-17585EC<br><i>Vertical Use Only</i> | 1¾ | 1¾ | 85¾ | 12      | 0.3      | \$ 362     |
|          | 17-17584EC                             | 1¾ | 1¾ | 84  | 11      | 0.3      | \$ 362     |
|          | 17-17573EC<br><i>Vertical Use Only</i> | 1¾ | 1¾ | 73¾ | 11      | 0.3      | \$ 358     |
|          | 17-17572EC                             | 1¾ | 1¾ | 72  | 11      | 0.3      | \$ 358     |
|          | 17-17561EC<br><i>Vertical Use Only</i> | 1¾ | 1¾ | 61¾ | 10      | 0.2      | \$ 350     |
|          | 17-17560EC                             | 1¾ | 1¾ | 60  | 10      | 0.2      | \$ 350     |
|          | 17-17549EC<br><i>Vertical Use Only</i> | 1¾ | 1¾ | 49¾ | 9       | 0.1      | \$ 295     |
|          | 17-17548EC                             | 1¾ | 1¾ | 48  | 9       | 0.1      | \$ 295     |
|          | 17-17537EC<br><i>Vertical Use Only</i> | 1¾ | 1¾ | 37¾ | 8       | 0.1      | \$ 289     |
|          | 17-17536EC                             | 1¾ | 1¾ | 36  | 8       | 0.1      | \$ 289     |
|          | 17-17525EC<br><i>Vertical Use Only</i> | 1¾ | 1¾ | 25¾ | 7       | 0.1      | \$ 284     |
|          | 17-17524EC                             | 1¾ | 1¾ | 24  | 7       | 0.1      | \$ 284     |
|          | 17-17522EC                             | 1¾ | 1¾ | 22¾ | 7       | 0.1      | \$ 280     |

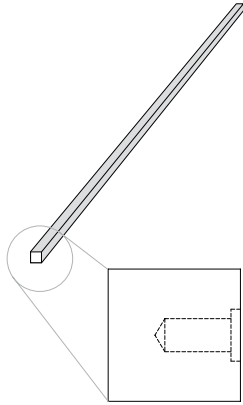

Must Specify (in this order):

Model # and Quantity  
Finish  
Hardware Color

**Description**

- Used Vertically and Horizontally to Provide a Clean, Balanced Aesthetic by Hiding Attachment Hardware
- Includes Bolts for Installation
- Blind-Threaded Insert for Installation

For ordering options, see overview at the beginning of this section.

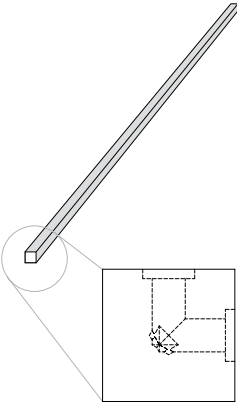
| Item   | Model No.  | W  | D  | H   | Ship Wt | Cubic Ft | List Price |
|--|------------|----|----|-----|---------|----------|------------|
| <b>CORNER POSTS</b><br> | 17-17597CP | 1¾ | 1¾ | 97¾ | 13      | 0.3      | \$ 373     |
|  | 17-17596CP | 1¾ | 1¾ | 96  | 12      | 0.3      | \$ 373     |
|  | 17-17585CP | 1¾ | 1¾ | 85¾ | 12      | 0.2      | \$ 366     |
|  | 17-17584CP | 1¾ | 1¾ | 84  | 11      | 0.2      | \$ 366     |
|  | 17-17573CP | 1¾ | 1¾ | 73¾ | 11      | 0.2      | \$ 362     |
|  | 17-17572CP | 1¾ | 1¾ | 72  | 11      | 0.2      | \$ 362     |
|  | 17-17561CP | 1¾ | 1¾ | 61¾ | 10      | 0.2      | \$ 357     |
|  | 17-17560CP | 1¾ | 1¾ | 60  | 10      | 0.2      | \$ 357     |
|  | 17-17549CP | 1¾ | 1¾ | 49¾ | 9       | 0.1      | \$ 297     |
|  | 17-17548CP | 1¾ | 1¾ | 48  | 9       | 0.1      | \$ 297     |
|  | 17-17537CP | 1¾ | 1¾ | 37¾ | 8       | 0.1      | \$ 291     |
|  | 17-17536CP | 1¾ | 1¾ | 36  | 8       | 0.1      | \$ 291     |
|  | 17-17525CP | 1¾ | 1¾ | 25¾ | 7       | 0.1      | \$ 287     |
|  | 17-17524CP | 1¾ | 1¾ | 24  | 7       | 0.1      | \$ 287     |
|  | 17-17522CP | 1¾ | 1¾ | 22¾ | 7       | 0.1      | \$ 281     |

Must Specify (in this order):

Model # and Quantity

Finish

Hardware Color

**Description**

- Used Vertically to make 90° Turns
- Includes Bolts for Installation
- Blind-Threaded Insert for Installation

For ordering options, see overview at the beginning of this section.

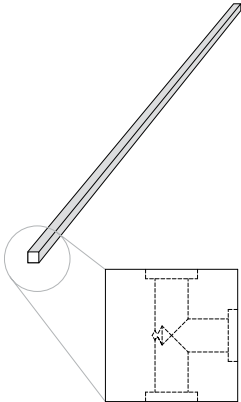
| Item  | Model No.   | W  | D   | H   | Ship Wt | Cubic Ft | List Price |
|---|-------------|----|-----|-----|---------|----------|------------|
|  | 17-17597TCB | 1¾ | 1¾  | 97¾ | 13      | 0.3      | \$ 376     |
|   | 17-17596TCB | 1¾ | 1¾  | 96  | 12      | 0.3      | \$ 376     |
|   | 17-17585TCB | 1¾ | 1¾  | 85¾ | 12      | 0.2      | \$ 372     |
|   | 17-17584TCB | 1¾ | 1¾  | 84  | 11      | 0.2      | \$ 372     |
|   | 17-17573TCB | 1¾ | 1¾  | 73¾ | 11      | 0.2      | \$ 364     |
|   | 17-17572TCB | 1¾ | 1¾  | 72  | 11      | 0.2      | \$ 364     |
|   | 17-17561TCB | 1¾ | 1¾  | 61¾ | 10      | 0.2      | \$ 361     |
|   | 17-17560TCB | 1¾ | 1¾  | 60  | 10      | 0.2      | \$ 361     |
|   | 17-17549TCB | 1¾ | 1¾  | 49¾ | 9       | 0.1      | \$ 298     |
|   | 17-17548TCB | 1¾ | 1¾  | 48  | 9       | 0.1      | \$ 298     |
|   | 17-17537TCB | 1¾ | 1¾  | 37¾ | 8       | 0.1      | \$ 294     |
|   | 17-17536TCB | 1¾ | 1¾  | 36  | 8       | 0.1      | \$ 294     |
|   | 17-17525TCB | 1¾ | 1¾  | 25¾ | 7       | 0.1      | \$ 289     |
|   | 17-17524TCB | 1¾ | 1¾  | 24  | 7       | 0.1      | \$ 289     |
| 17-17522TCB   | 1¾          | 1¾ | 22¾ | 7   | 0.1     | \$ 284   |            |

Must Specify (in this order):

Model # and Quantity

Finish

Hardware Color

**Description**

- Used Vertically to Connect Three (3) Walls
- Includes Bolts for Installation
- Blind-Threaded Insert for Installation

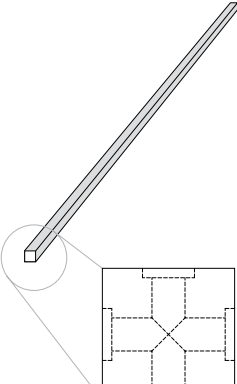
| Item  | Model No.  | W  | D  | H   | Ship Wt | Cubic Ft | List Price |
|---|------------|----|----|-----|---------|----------|------------|
|  | 17-17597XB | 1¾ | 1¾ | 97¾ | 13      | 0.3      | \$ 379     |
|   | 17-17585XB | 1¾ | 1¾ | 85¾ | 12      | 0.2      | \$ 375     |
|   | 17-17573XB | 1¾ | 1¾ | 73¾ | 11      | 0.2      | \$ 371     |
|   | 17-17561XB | 1¾ | 1¾ | 61¾ | 10      | 0.2      | \$ 364     |
|   | 17-17549XB | 1¾ | 1¾ | 49¾ | 9       | 0.1      | \$ 300     |
|   | 17-17537XB | 1¾ | 1¾ | 37¾ | 8       | 0.1      | \$ 296     |
|   | 17-17525XB | 1¾ | 1¾ | 25¾ | 7       | 0.1      | \$ 290     |
|   | 17-17522XB | 1¾ | 1¾ | 22¾ | 7       | 0.1      | \$ 287     |

#### Description

- Used Vertically to Connect Four (4) Wall Runs
- Includes Bolts for Installation
- Blind-Threaded Insert for Installation

#### Must Specify (in this order):

Model # and Quantity  
Finish  
Hardware Color

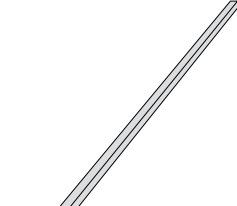
| Item  | Model No.    | W   | D  | H  | Ship Wt | Cubic Ft | List Price |
|---|--------------|-----|----|----|---------|----------|------------|
|  | 17-175120HBS | 120 | 1¾ | 1¾ | 14      | 0.3      | \$ 384     |
|   | 17-175108HBS | 108 | 1¾ | 1¾ | 12      | 0.3      | \$ 366     |
|   | 17-17596HBS  | 96  | 1¾ | 1¾ | 12      | 0.3      | \$ 353     |
|   | 17-17584HBS  | 84  | 1¾ | 1¾ | 11      | 0.2      | \$ 335     |
|   | 17-17572HBS  | 72  | 1¾ | 1¾ | 11      | 0.2      | \$ 325     |

#### Description

- Used Horizontally to Provide Structural Support for Doorways and Other Openings
- Includes Bolts for Installation
- Blind-Threaded Insert for Installation
- Holes Bored Only on Ends to Accommodate Attachment

#### Must Specify (in this order):

Model # and Quantity  
Finish  
Hardware Color

For ordering options, see overview at the beginning of this section.

| Item           | Model No.   | W           | D   | H | Ship Wt | Cubic Ft | List Price |
|----------------|-------------|-------------|-----|---|---------|----------|------------|
| BARN DOOR WALL | Left        | Right       |     |   |         |          |            |
|                | 17-4896BDBL | 17-4896BDBR | 120 | 4 | 103     | 289      | 271        |

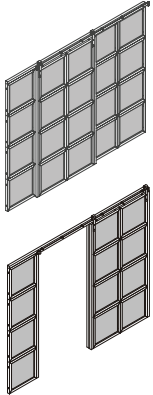

Shown as Right Barn Door

**Must Specify (in this order):**

Model #  
Finish  
Hardware Color  
Acrylic or Acoustic Panels/Color

**Description**

- Standard with: Blocks, Beam Spanner, Four (4) End Caps, and Hardware to Create An *Approximately* 10"W x 8½"H Wall with Barn Door, including Leveling Glides
- Barn Door Features Soft Open and Soft Close to Avoid Door Slamming
- Must Specify Finish and Hardware Color (Door Track Available in Black Only)
- Must Specify Acrylic and/or Acoustical Inserts for Use in Barn Door Wall (Total 20 Inserts); Note: List Price Shown Above Does NOT Include These Required Inserts Due to Variance in Pricing

**Must Specify Insert Options: 20 Acrylic and/or Acoustical Inserts (any combination)**

| AP-2020AP | Acoustic Insert - Must Specify Color Option and Add; <a href="#">See Acoustic Color Options</a> |  |        |
|-----------|---|--|--------|
| MLK       | Milky   |  | \$ 244 |
| TPE       | Taupe   |  | \$ 244 |
| GRY       | Grey  |  | \$ 244 |
| ASH       | Ash   |  | \$ 244 |
| BLK       | Black   |  | \$ 244 |
| AI-2020AC | Acrylic Insert - Must Specify Color Option and Add; <a href="#">See Acrylic Color Options</a>   |  |        |
| FSTA      | Frosted   |  | \$ 284 |
| TGWA      | Twigwork  |  | \$ 546 |
| WOVA      | Woven   |  | \$ 546 |
| RAFA      | Raffia  |  | \$ 546 |
| TNSA      | Tinsel  |  | \$ 546 |

|             |           |     |    |   |    |     |        |
|-------------|-----------|-----|----|---|----|-----|--------|
| PLANTER BOX | 01-1909PL | 19¼ | 9½ | 6 | 16 | 2.0 | \$ 534 |
|-------------|-----------|-----|----|---|----|-----|--------|

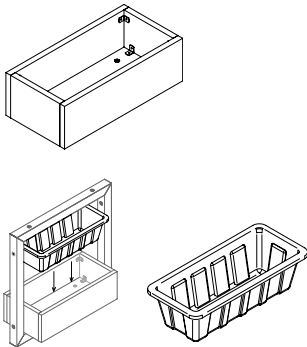
**Description**

- Material is TFL. Must Specify TFL (T) Color; [See Color Options](#)
- Planter Will Ship with Attachment Hardware: Two (2) Black and Two (2) Nickel Bolts
- Horizontal Grain
- Planter Boxes Cannot be Installed on Both Sides of a Corner
- Optional Planter Box Insert Sold Separately

**Option: Specify & Add**

|     |                                   |  |       |
|-----|-----------------------------------|--|-------|
| PBI | Planter Box Insert, Black Plastic |  | \$ 49 |
|-----|-----------------------------------|--|-------|

**Must Specify (in this order):**

Model #  
TFL Color  
Optional Planter Insert

For ordering options, see overview at the beginning of this section.

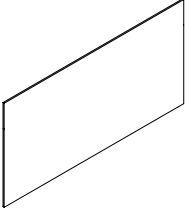
| Item  | Model No.          | W   | D | H   | Ship Wt | Cubic Ft | List Price |
|---|--------------------|-----|---|-----|---------|----------|------------|
| ACOUSTICAL PANEL<br>ONSET INSTALLATION<br> | <b>46"H Panels</b> |     |   |     |         |          |            |
|   | AP-4670AP          | 70¼ | ½ | 46¼ | 13      | 7.6      | \$ 1169    |
|   | AP-4658AP          | 58¼ | ½ | 46¼ | 12      | 6.3      | \$ 988     |
|   | AP-4646AP          | 46¼ | ½ | 46¼ | 10      | 5.1      | \$ 837     |
|   | <b>22"H Panels</b> |     |   |     |         |          |            |
|   | AP-2270AP          | 70¼ | ½ | 22¼ | 9       | 4.1      | \$ 589     |
|   | AP-2258AP          | 58¼ | ½ | 22¼ | 8       | 3.4      | \$ 492     |
|   | AP-2246AP          | 46¼ | ½ | 22¼ | 8       | 2.8      | \$ 415     |
|   | AP-2234AP          | 34¼ | ½ | 22¼ | 7       | 2.1      | \$ 346     |
|   | AP-2222AP          | 22¼ | ½ | 22¼ | 6       | 1.4      | \$ 244     |

Must Specify (in this order):

Model #

Color

#### Description

- Onset Application, Installed with Dual-Lock Connectors
- Sound Absorption Rating Average NRC 0.75 (50 mm Air Gap) 1.0 NRC in Mid-High Frequencies
- Cannot be Used on Same Side as TV Mount
- For Space Planning with Furniture, Note the Onset Application Will Add ½" to the Square One Blocks

#### Color Options: Must Specify; [See Color Options](#)

MLK Milky

TPE Taupe

GRY Grey

ASH Ash

BLK Black

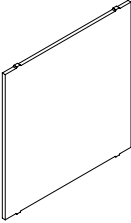
|   |                       |     |   |     |   |     |        |
|---|-----------------------|-----|---|-----|---|-----|--------|
| ACOUSTICAL PANEL<br>INSET INSTALLATION<br> | <b>For 24" Blocks</b> |     |   |     |   |     |        |
|   | AP-2020AP             | 20¼ | ½ | 20¼ | 6 | 1.4 | \$ 244 |
|   | <b>For 12" Blocks</b> |     |   |     |   |     |        |
|   | AP-0820AP             | 20¼ | ½ | 8¼  | 3 | 0.8 | \$ 211 |

#### Description

- Inset Application; Includes Tabs to Secure in Place
- Sound Absorption Rating Average NRC 0.75 (50 mm Air Gap) 1.0 NRC in Mid-High Frequencies
- Cannot be Used with TV Mount

#### Color Options: Must Specify; [See Color Options](#)

MLK Milky

TPE Taupe

GRY Grey

ASH Ash

BLK Black



Must Specify (in this order):

Model #

Color

For ordering options, see overview at the beginning of this section.

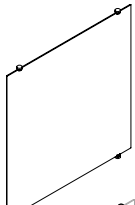
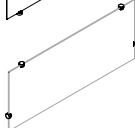

| Item  | Model No.                             | W   | D | H   | Ship Wt | Cubic Ft | List Price   |
|---|---------------------------------------|-----|---|-----|---------|----------|--------------|
| <b>ACRYLIC INSERTS</b>  |                                       |     |   |     |         |          |              |
| <b>For 24" Blocks</b>   |                                       |     |   |     |         |          |              |
|  | AI-2020AC                             | 20¼ | ½ | 20¼ | 7       | 2.0      | \$ See Below |
| <b>For 12" Blocks</b>   |                                       |     |   |     |         |          |              |
|  | AI-2008AC                             | 8¼  | ½ | 20¼ | 6       | 2.0      | \$ See Below |
|   | <i>Vertical Insert Applications</i>   |     |   |     |         |          |              |
|  | AI-0820AC                             | 20¼ | ½ | 8¼  | 6       | 2.0      | \$ See Below |
|   | <i>Horizontal Insert Applications</i> |     |   |     |         |          |              |

Insert Retainer

Must Specify (in this order):

Model #  
Color  
Special Custom Logo

**Description**

- Inserted Into 24" or 12" Blocks with Insert Retainers (Included)
- Raffia's Linear Pattern will be Installed Vertically on Both AI-2008AC (Vertical) and AI-0820AC (Horizontal)
- Frosted Acrylic Inserts can be customized with a logo or design using one of the following file types: .CDR, .AI, or .EPS. Email the image to [customproduct@indianafurniture.com](mailto:customproduct@indianafurniture.com) for a quote. Additional costs and lead times may apply. Note this as a special on your order when submitting.

**Color Options: Must Specify; See Color Options**

|      |          | For 12" Blocks | For 24" Blocks |
|------|----------|----------------|----------------|
| FSTA | Frosted  | \$ 184         | 284            |
| TGWA | Twigwork | \$ 296         | 546            |
| WOVA | Woven    | \$ 296         | 546            |
| RAFA | Raffia   | \$ 296         | 546            |
| TNSA | Tinsel   | \$ 296         | 546            |

**For 12" Blocks**

Raffia (RAFA)  
Vertical Installation  
Standard

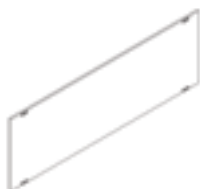
**DRY ERASE BOARDS**

| <b>46"H Panels</b> |            |     |   |     |    |     |         |
|--------------------|------------|-----|---|-----|----|-----|---------|
|                    | 17-4670DEB | 70¼ | ¾ | 46¼ | 11 | 0.2 | \$ 1641 |
|                    | 17-4658DEB | 58¼ | ¾ | 46¼ | 11 | 0.2 | \$ 1361 |
|                    | 17-4646DEB | 46¼ | ¾ | 46¼ | 11 | 0.2 | \$ 1080 |
| <b>22"H Panels</b> |            |     |   |     |    |     |         |
|                    | 17-2270DEB | 70¼ | ¾ | 22¼ | 11 | 0.2 | \$ 1108 |
|                    | 17-2258DEB | 58¼ | ¾ | 22¼ | 11 | 0.2 | \$ 895  |
|                    | 17-2246DEB | 46¼ | ¾ | 22¼ | 11 | 0.2 | \$ 712  |

Must Specify (in this order):

Model #  
Color

**Description**

- Nuts and Bolts Included for Onset Attachment
- May be Applied Horizontally or Vertically
- For Space Planning with Furniture, Note the Onset Application Will Add ¾" to the Square One Blocks

For ordering options, see overview at the beginning of this section.

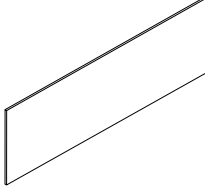
| Item  | Model No.                     | W   | D | H   | YARDS |    | GRADE<br>COM/1/2/3 | GRADE<br>4 | GRADE<br>5 | GRADE<br>6 | GRADE<br>7 | GRADE<br>8 | GRADE<br>9 | GRADE<br>10 |  |
|---|-------------------------------|-----|---|-----|-------|----|--------------------|------------|------------|------------|------------|------------|------------|-------------|--|
| <b>TACKABLE PANELS</b><br> | <b>46"H Panels (2 pieces)</b> |     |   |     |       |    |                    |            |            |            |            |            |            |             |  |
|   | TB-4670TB                     | 70¼ | ⅝ | 46¼ | 8.75  | \$ | 2024               | 3162       | 3695       | 4238       | 5017       | 5813       | 6758       | 7834        |  |
|   | TB-4658TB                     | 58¼ | ⅝ | 46¼ | 7.25  | \$ | 1785               | 2728       | 3170       | 3619       | 4265       | 4924       | 5707       | 6599        |  |
|   | TB-4646TB                     | 46¼ | ⅝ | 46¼ | 6.00  | \$ | 1545               | 2325       | 2691       | 3063       | 3597       | 4143       | 4791       | 5529        |  |
|   | <b>22"H Panels (1 piece)</b>  |     |   |     |       |    |                    |            |            |            |            |            |            |             |  |
|   | TB-2270TB                     | 70¼ | ⅝ | 22¼ | 4.50  | \$ | 1117               | 1702       | 1977       | 2256       | 2656       | 3066       | 3552       | 4105        |  |
|   | TB-2258TB                     | 58¼ | ⅝ | 22¼ | 3.75  | \$ | 970                | 1458       | 1686       | 1919       | 2253       | 2594       | 2999       | 3460        |  |
|   | TB-2246TB                     | 46¼ | ⅝ | 22¼ | 3.00  | \$ | 817                | 1207       | 1390       | 1576       | 1843       | 2116       | 2440       | 2809        |  |
|   | TB-2234TB                     | 34¼ | ⅝ | 22¼ | 2.50  | \$ | 667                | 992        | 1145       | 1300       | 1522       | 1750       | 2020       | 2327        |  |
|   | TB-2222TB                     | 22¼ | ⅝ | 22¼ | 1.75  | \$ | 512                | 740        | 846        | 955        | 1111       | 1270       | 1459       | 1674        |  |

Must Specify (in this order):

Model #

Fabric Vendor/Pattern/Color

#### Description

- Installed with Dual-Lock Connectors
- Tackable Panels are Fully Upholstered on Both Sides.
- For Space Planning with Furniture, Note the Onset Application Will Add ⅝" to the Square One Blocks

| Item       | Model No. | W  | D | H | Ship Wt | Cubic Ft | List Price |
|------------|-----------|----|---|---|---------|----------|------------|
| TV BRACKET | 01-TVBR   | 3½ | 4 | 3 | 1       | 1.0      | \$ 130     |

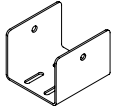

#### Description

- Black Metal
- Coordinates with TV Mount

|          |         |     |   |     |    |     |         |
|----------|---------|-----|---|-----|----|-----|---------|
| TV MOUNT | 01-TVMT | 35¾ | ⅞ | 21⅝ | 15 | 0.5 | \$ 1026 |
|----------|---------|-----|---|-----|----|-----|---------|

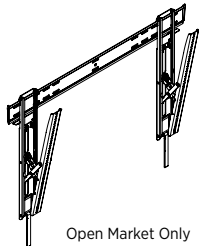

#### Description

- Available in Black; Provides 12° of Smooth, Fingertip Tilt
- Compatible with Ultra-Thin TVs 2" (51 mm) Deep or Less; Typical Screen Sizes: 37" - 63"
- Weight Capacity: 100 lbs (45.4 kg)
- Can be Installed in Landscape Mode Only
- Must Order Two (2) 01-TVBR to Mount TV
- Not Compatible with Acrylic or Acoustical Inserts; Can be Used with Onset Acoustical Panels when Used on Opposite Sides

|             |           |  |  |  |   |     |       |
|-------------|-----------|--|--|--|---|-----|-------|
| LEVELER KIT | 17-LEVKIT |  |  |  | 1 | 1.0 | \$ 49 |
|-------------|-----------|--|--|--|---|-----|-------|

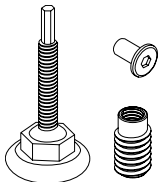

#### Description

- Includes Two (2) Levelers, Two (2) Insert Nuts and Two (2) Cap Nuts
- Must Specify Black (BLK) or Nickel (NCKL)

Must Specify (in this order):

Model # and Quantity

Hardware Color

For ordering options, see overview at the beginning of this section.

| Item             | Model No. | W | D | H | Ship Wt | Cubic Ft | List Price |
|------------------|-----------|---|---|---|---------|----------|------------|
| ALLEN DRIVER BIT | 17-TOOL   | - | - | - | 1       | 1.0      | \$ 55      |

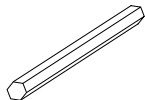
**Description**

- Used for Inserting Glide Insert Nuts for Levelers
- 6mm Allen Driver Bit

|                       |                |   |   |   |   |     |       |
|-----------------------|----------------|---|---|---|---|-----|-------|
| 80MM BOLT AND NUT KIT | 17-80MMBOLTKIT | - | - | - | 1 | 1.0 | \$ 47 |
|-----------------------|----------------|---|---|---|---|-----|-------|

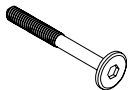

**Description**

- Quantity of Eight (8)
- For Connecting Block to Block
- Must Specify Black (BLK) or Nickel (NCKL)

Must Specify (in this order):

Model # and Quantity  
Hardware Color

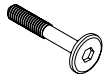
|                       |                |   |   |   |   |     |       |
|-----------------------|----------------|---|---|---|---|-----|-------|
| 60MM BOLT AND NUT KIT | 17-60MMBOLTKIT | - | - | - | 1 | 1.0 | \$ 37 |
|-----------------------|----------------|---|---|---|---|-----|-------|

**Description**

- Quantity of Eight (8)
- For Connecting Block to Beam, Post, or End Cap
- Must Specify Black (BLK) or Nickel (NCKL)

Must Specify (in this order):

Model # and Quantity  
Hardware Color

|                       |                |   |   |   |   |     |       |
|-----------------------|----------------|---|---|---|---|-----|-------|
| 12MM BOLT AND NUT KIT | 17-12MMBOLTKIT | - | - | - | 1 | 1.0 | \$ 36 |
|-----------------------|----------------|---|---|---|---|-----|-------|

**Description**

- Quantity of Eight (8)
- For Covering Exposed Holes in Rails Only
- Must Specify Black (BLK) or Nickel (NCKL)

Must Specify (in this order):

Model # and Quantity  
Hardware Color

For ordering options, see overview at the beginning of this section.

| Item               | Model No. | W   | D  | H   | Ship Wt | Cubic Ft | List Price |
|--------------------|-----------|-----|----|-----|---------|----------|------------|
| VESTA POWER CENTER | 01-PDCTR  | 10¾ | 12 | 28¾ | 14      | 2.5      | \$ 1666    |



#### Description

- Top Includes One (1) Power Outlet, Two (2) USB Ports and One (1) USBC Port; Base Includes Three (3) Outlet
- Available in White
- 120" Power Cord
- Built with Weight Distribution for Optimal Stability
- Base is 5" Tall

|                              |          |     |   |     |   |     |        |
|------------------------------|----------|-----|---|-----|---|-----|--------|
| TIC-TAC-TOE<br>FOAM GAME SET | 17-XOSET | 20¾ | 2 | 20¾ | 6 | 3.0 | \$ 339 |
|------------------------------|----------|-----|---|-----|---|-----|--------|



















#### Description

- Set Includes Five (5) Xs (Charcoal Gray) and Four (4) Os (Light Gray)
- Constructed of Polyurethane Foam

For ordering options, see overview at the beginning of this section.

# Surface Materials

## Wood Finishes and Woodgrain, Solid, and 3D Laminates







|   |   |   |  |  |  |
|---|---|---|--|--|--|
|    |    |    |    |   |   |
| <b>Beigewood (BW)</b><br>TFL, HPL, Seating*   | <b>Sugar Maple (SM)</b><br>Veneer, TFL, HPL, Seating                                | <b>Oak Riftwood (ORW)</b><br>Veneer*, TFL, HPL, Seating*                            | <b>Sunglow Walnut (SW)</b><br>Veneer, Seating  | <b>Fawn Oak (FO)</b><br>Veneer*, Seating*  | <b>Weathered Ash (WTA)</b><br>Veneer*, TFL, HPL, Seating*                            |
|    |    |    |    |   |   |
| <b>Smoky Brown Pear (SBP)</b><br>Veneer, TFL, HPL, Seating*                         | <b>Asian Night (AS)</b><br>Veneer, TFL, HPL, Seating                                | <b>Studio Teak (TK)</b><br>TFL, HPL, Seating  | <b>Pinnacle Walnut (PNW)</b><br>TFL, HPL, Seating                                    | <b>Harvest Maple (HVM)</b><br>Veneer, TFL, HPL, Seating*                             | <b>Medium Oak (MO)</b><br>Veneer*, Seating*  |
|    |    |    |    |   |   |
| <b>Golden Cherry (GC)</b><br>Veneer, TFL, HPL, Seating                              | <b>Legacy Walnut (LW)</b><br>Veneer, Seating  | <b>Artisan Walnut (AW)</b><br>Veneer, Seating                                       | <b>Shaker Cherry (SKC)</b><br>Veneer, TFL, HPL, Seating                              | <b>Select Cherry (SCH)</b><br>Veneer, TFL, HPL, Seating                              | <b>Williamsburg Cherry (WC)</b><br>Veneer, TFL, HPL, Seating                         |
|    |    |    |    |   |   |
| <b>Harvest Walnut (HW)</b><br>Veneer, Seating                                       | <b>Dark Cherry (DC)</b><br>Veneer, Seating  | <b>Mahogany Walnut (MW)</b><br>Veneer, TFL, HPL, Seating                            | <b>Columbian Walnut (CO)</b><br>Veneer, TFL, HPL, Seating                            | <b>Dark Forest Walnut (DFW)</b><br>Veneer, Seating*                                  | <b>Espresso (EW/EF)</b><br>Veneer, TFL, HPL, Seating                                 |
|    |    |    |    |   |   |
| <b>Designer White (WH)</b><br>TFL, HPL, Seating                                     | <b>White Sand (WHS)</b><br>TFL, HPL   | <b>Fashion Grey (FHG)</b><br>TFL, HPL   | <b>Pepperdust (PPD)</b><br>TFL, HPL  | <b>Slate Grey (SG)</b><br>TFL, HPL   | <b>Black (BL)</b><br>TFL, HPL, Seating   |
|   |   |   |   |  |  |
| <b>Pewter Mesh (PTM)</b><br>HPL (training tables only)                              | <b>Steel Mesh (STM)</b><br>HPL (training tables only)                               | <b>Matte White (WH3)</b><br>3D Laminate (Iconic Only)                               | <b>Concrete (CR3)</b><br>3D Laminate (Iconic Only)                                   | <b>Matte Black (BL3)</b><br>3D Laminate (Iconic Only)                                | <b>Enamel (ENL)</b><br>HPL Accent (Iconic Only)                                      |
|  |  |  |  |  |  |
| <b>Blush (BSH)</b><br>HPL Accent (Iconic Only)                                      | <b>First Kiss (FK)</b><br>HPL Accent (Iconic Only)                                  | <b>Surfin USA (SUS)</b><br>HPL Accent (Iconic Only)                                 | <b>Summer Vacation (SV)</b><br>HPL Accent (Iconic Only)                              |  |  |

\* Finish is Low Sheen

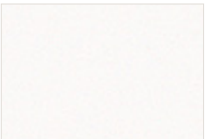



## Frosted & High Gloss Acrylics

|   |   |   |  |   |
|---|---|---|--|---|
|  |  |  |  |  |
| <b>Frosted (FSTA)</b>   | <b>White (WHA)</b>  | <b>Wired Mercury (WMA)</b>  | <b>Graphite (GPA)</b>  | <b>Black (BLA)</b>  |

## Solid Surfaces

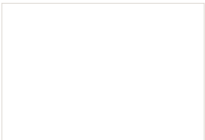
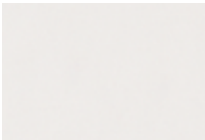
|   |   |   |  |   |   |
|---|---|---|--|---|---|
|  |  |  |  |  |  |
| <b>Snow White (SNW)</b>   | <b>Pebble Beach (PE)</b>  | <b>Sedona (SE)</b>  | <b>Arroyo (AR)</b>   | <b>Tundra (TN)</b>  | <b>Starry Night (SN)</b>  |

## Metal Options

|   |   |   |  |   |   |
|---|---|---|--|---|---|
|  |  |  |  |  |  |
| <b>Oyster White (OYST)</b>  | <b>Sugar Cookie (SUGC)</b>  | <b>Aluminum (ALUM)</b>  | <b>Chrome (CHRM)</b>   | <b>Mist (MIST)</b>  | <b>Black (BLK) / Noir (NOIR)</b>  |

Colors represented are high-resolution reproductions and may vary slightly from the actual product. To order samples, please contact our Customer Service team or order online at [www.indianafurniture.com](http://www.indianafurniture.com). Graining and finish colors may vary yet will continue to complement, across Veneer, HPL, TFL, and Seating products due to the inherent differences of these materials.

# Indiana<sup>®</sup> FURNITURE

1224 Mill Street  
PO Box 270  
Jasper, Indiana 47547-0270

Tel 812.482.5727  
Toll 800.422.5727  
Fax 812.482.9035  
[sales@indianafurniture.com](mailto:sales@indianafurniture.com)  
[www.indianafurniture.com](http://www.indianafurniture.com)

**Federal Classification: Small Business**

©2022 Indiana Furniture 3/22

