

# RESILIENCE

## Casegoods Series

Price List

Effective 3.15.09

Add 3.75% List Price Increase Effective May 1, 2011

INDIANA  
FURNITURE

**INDIANA FURNITURE  
PRODUCT WARRANTY**

Indiana Furniture warrants the products manufactured by it to be free from defects in material and workmanship as follows: (a) casegoods for a period of twelve (12) years of single shift service from the date of purchase; and (b) seating for a period of five (5) years of single shift service from the date of purchase with the exception of the Marquee Series, which shall be covered for a period of twelve (12) years of single shift service from the date of purchase.

During the applicable warranty period, Indiana Furniture, as its sole obligation, will repair or replace (at its option) any product, part, or component covered by this warranty and sold after June 1, 2010, which fails under normal use as a result of a defect in material or workmanship. Indiana Furniture will repair or replace the aforementioned product, part, or component with a comparable product, part or component.

This warranty extends only to the original purchasers who acquire new Indiana Furniture products through authorized dealers, or from others specifically authorized by Indiana Furniture to sell its products. Any product, part, or component must have been installed and maintained according to Indiana Furniture's published instructions in order to be eligible for coverage under this warranty and must not have been subject to misuse or abuse. Any improper assembly, modification, alteration, attachment, misuse, abuse, or negligent use by the purchaser or the dealer will void this warranty. Indiana Furniture does not warrant the performance of the product when used in combination with other than original Indiana Furniture products.

This warranty covers all defects encountered in the normal use of Indiana Furniture products, but does not apply to the following:

- damage caused by carrier
- COM/COL (Customers Own Material/Leather) specified
- color, grain or texture of wood and other covering materials due to natural variations
- changes in wood or fabric color due to aging or exposure to light
- defects or damages arising out of the coverage of furniture tops with glass or other foreign materials
- normal wear and tear

As the manufacturer of your furniture, Indiana Furniture stands behind its craftsmanship and pledges to do everything it can to resolve, as quickly as possible, any problems you may have within the terms and conditions of this warranty.

If you encounter a defect covered by the foregoing warranty, you should contact the dealer from whom the product was purchased. In the event the dealer is unable to resolve your warranty issues, you should contact Indiana Furniture. Please ensure that you have all of the pertinent facts when contacting the dealer or Indiana Furniture, including the model number and factory order number from the inspection label attached to the product.

You may contact us as follows:

Telephone:  
1-812-482-5727  
1-800-422-5727 USA  
1-800-362-9470 Canada  
1-812-482-9035 Facsimile

Email:  
[custserv@indianafurniture.com](mailto:custserv@indianafurniture.com)

Mail:  
Indiana Furniture  
Attn: Quality Assurance Manager  
1224 Mill Street, P.O. Box 270  
Jasper, Indiana 47547-0270

This document includes all of the warranties given and remedies available with respect to the products manufactured by Indiana Furniture. Indiana Furniture disclaims any other warranties, whether expressed or implied, statutory or otherwise, to the extent legally permissible.

**TO THE EXTENT ALLOWED BY LAW, ANY IMPLIED WARRANTIES, INCLUDING ANY WARRANTY OF MERCHANTABILITY OR FITNESS FOR A PARTICULAR PURPOSE, ARE EXPRESSLY DISCLAIMED.**

**INDIANA FURNITURE SHALL NOT BE LIABLE FOR LOSS OF TIME, CONVENIENCE, COMMERCIAL LOSS OR INCIDENTAL OR CONSEQUENTIAL DAMAGES ARISING FROM ANY PRODUCT DEFECT.**

# RESILIENCE 3800 SERIES



Resilience



## LAMINATES

Exposed surfaces are produced from wood grained, patterned and solid color laminates fused to a particle-board core. Each laminate offers lasting beauty, superior resistance to normal wear and easy maintenance.

## TOPS

HPL tops are 3-ply construction, 1 $\frac{3}{16}$ " thick with PVC rims. Tops are shaped on all four sides for complete design appeal. Tops are available in six wood-look laminates, one nebula pattern laminates and two different edge details.

## CHASSIS CONSTRUCTION

Tops, end panels, and modesty panels are assembled using European-style mechanical fasteners and heavy-duty 16 gauge joining brackets. Laminate parting rails assure a sturdy pedestal. All units are equipped with heavy-duty adjustable glides to ensure proper leveling and compensate for uneven floors.

## DRAWERS

All drawer fronts feature laminated fronts with banded edges. Fronts are 3-ply construction and  $\frac{3}{4}$ " thick. Drawer sides and backs are constructed with  $\frac{7}{16}$ " thick black MDF and  $\frac{1}{8}$ " hardboard bottoms. Drawers feature 5-sided construction allowing for easy removal of drawer fronts.

## DRAWER SUSPENSION

File drawers and box drawers feature high quality, black progressive full extension slides with precision steel ball bearings to ensure a smooth, quiet operation. All suspensions have a lifetime warranty.

## FILING HARDWARE

All file drawers are standard with custom fitted filing systems designed to accommodate a variety of filing requirements. Desk file drawers provide legal filing front to back, and legal filing or two rows of letter filing side to side. Credenza/return file drawers provide legal filing front to back, and legal or letter filing side to side.

## LOCKING MECHANISM

All pedestals and files feature locking. Removable lock cylinders allow for units to be re-keyed at a later date if required. Units are shipped randomly keyed as standard.

## CORD MANAGEMENT

Black grommets are standard in back panels of assembled returns, bridge units, kneespace credenzas and hutch units. Grommets are also standard in tops of assembled corner units, and extended corner tops. Grommets may be ordered in the tops of assembled double and single pedestal desks and component workspaces. See page 122 for worksurface grommet options. Undersurface cord managers are also available for additional cord management.

## RESILIENCE 3800 INTERIOR DRAWER DIMENSIONS

Item	Drawers	W	L	D
38-4272DP	Box	14 $\frac{9}{16}$	25 $\frac{1}{4}$	3 $\frac{21}{32}$
38-3672DP	File	14 $\frac{13}{16}$	25 $\frac{1}{4}$	8 $\frac{29}{32}$
38-3066DP				
38-4272LP				
38-4272RP				
38-3672LP				
38-3672RP				
38-3066LP				
38-3066RP				
38-3618PD				
38-3018PD				
38-4278CLP	Box	14 $\frac{9}{16}$	19 $\frac{1}{4}$	3 $\frac{21}{32}$
38-4278CRP	File	14 $\frac{13}{16}$	19 $\frac{1}{4}$	8 $\frac{29}{32}$
38-3672WC1				
38-3672WC2				
38-2442CLF				
38-2442CLR				
38-2448LF				
38-2448RF				
38-2472SC				
38-2472KC				
38-2466KC				
38-2472LC				
38-2472RC				
38-2466LC				
38-2466RC				
38-2418PD				
38-1872STL				
38-1872STR				
38-1824MP				
38-1824MP2	Top File	14 $\frac{13}{16}$	16 $\frac{3}{8}$	8 $\frac{29}{32}$
	Btm File	14 $\frac{13}{16}$	19 $\frac{1}{4}$	8 $\frac{29}{32}$
38-2436L2	File	32 $\frac{3}{16}$	19 $\frac{1}{4}$	8 $\frac{29}{32}$
38-2436L3				
38-2436L4				
38-2436LF1				
38-2436TF				
38-2436QF				
38-3672VC	Box	32 $\frac{3}{16}$	19 $\frac{1}{4}$	3 $\frac{21}{32}$
38-3672SU1	File	32 $\frac{3}{16}$	19 $\frac{1}{4}$	8 $\frac{29}{32}$
38-2436LF2	Box	14 $\frac{9}{16}$	19 $\frac{1}{4}$	3 $\frac{21}{32}$
38-2436LF4	$\frac{1}{2}$ Wide File	14 $\frac{13}{16}$	19 $\frac{1}{4}$	8 $\frac{29}{32}$
	File	32 $\frac{3}{16}$	19 $\frac{1}{4}$	8 $\frac{29}{32}$
	Wide Box	32 $\frac{3}{16}$	19 $\frac{1}{4}$	3 $\frac{21}{32}$
38-2122CD	Center	19 $\frac{5}{8}$	19 $\frac{1}{8}$	1 $\frac{29}{32}$
38-1622CD	Center	19 $\frac{5}{8}$	15 $\frac{1}{8}$	1 $\frac{29}{32}$

Add 3.75% List Price Increase Effective May 1, 2011

**How To Order:**

38 - 4272DP1 - YC - CN - K - MBA  
 |           |           |           |           |  
 Series    Model #   Chassis    Top    Edge    Pull  
                           Laminate   Laminate

**Note:** Order must be listed as shown, with Chassis Color and Top Color specified separately.

**Color Codes:**

<u>Top or Chassis Laminate Options</u>		<u>Top Only Laminate Option</u>	<u>Chassis Only Laminate Option</u>		
SM	Sugar Maple	CN	Charcoal Nebula	BL	Black
YC	Yorkshire Cherry				
VM	Victorian Mahogany				
CC	Classic Cherry				
EF	Espresso				
LM	Light Maple				

**Edge Options:**



Flute  
K



Square  
L

**Pull Options:**

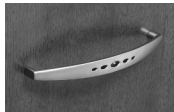

Aluminum Orbit  
AOR

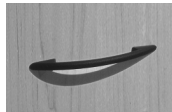

Matte Black Arch  
MBA

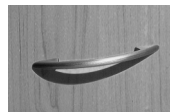

Pewter Arch  
PTA



Black Orbit  
BOR

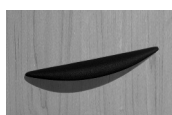

Matte Black Waterfall  
MBW



Pewter Waterfall  
PTW

**Resilience**



Add 3.75% List Price Increase Effective May 1, 2011

# RESILIENCE 3800 SERIES

## Standard Options

### GROMMET LOCATIONS

Add upcharge of \$41 list for each grommet.

Specify grommet locations:

- GL - Grommet Left
- GC - Grommet Center
- GR - Grommet Right

**Example:** 38-3672DP2-GL-GR (Grommet Left, Grommet Right)

Standard grommet locations are available on cockpit units on pages 130-133. Contact Customer Service for more information.

Grommets may be ordered in non-standard locations. Please attach a drawing to the purchase order showing the location of the grommet.

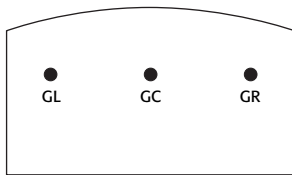

38-4272DP  
38-4272LP  
38-4272RP  
38-4272BWT  
38-3672BWT

GL/GR - 9" from ends, 27¼" from user side.  
GC - 27¼" from user side.

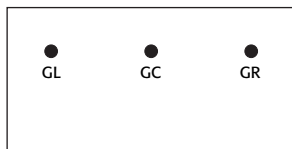

38-3672DP  
38-3672LP  
38-3672RP  
38-3672TP

GL/GR - 9" from ends, 27¼" from user side.  
GC - 27¼" from user side.

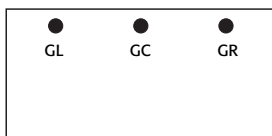

38-3066DP  
38-3066LP  
38-3066RP  
38-3066TP

GL/GR - 9" from ends, 27¼" from user side.  
GC - 27¼" from user side.



38-2430TP  
38-2436TP  
38-2436UF  
38-2436UFH  
38-2442UF  
38-2442UFH  
38-2448LF1/RF1  
38-2448LF2/RF2  
38-2448TP  
38-2448UF  
38-2448UFH  
38-2454TP  
38-2460TP

38-2466KC1-2-3-4  
38-2466LC1/RC1  
38-2466RC2/LC2  
38-2466TP  
38-2472KC1-2-3-4  
38-2472RC1/LC1  
38-2472RC2/LC2  
38-2472TP  
38-2478TP  
38-2484TP  
38-2490TP  
38-24102TP  
38-24108TP

GL/GR - 9" from ends, 21¼" from user side.  
GC - 21¼" from user side.

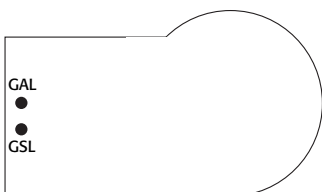

38-4272PR  
38-4272TR  
38-3672PR  
38-3672TR

GAL/GSL - 12" from approach or seated side, 4" from end.

### GROMMET LOCATIONS - CONTINUED

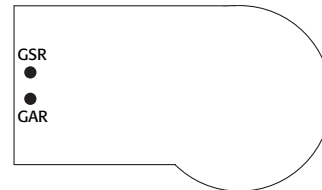

38-4272PL  
38-4272TL  
38-3672PL  
38-3672TL

GSR/GAR - 12" from approach or seated side, 4" from end.



38-3672DU 38-3672DR  
38-3072DU 38-3072DR  
38-3066DU 38-3066DR  
38-3060DU

GAL/GSL - 12" from approach or seated side, 4" from end.

### LOCKING HUTCH DOORS

Locking doors are available on hutches.

Please specify with locking and add \$60 list to the following units.  
38-1472HD 38-1466HD

Please specify with locking and add \$48 list to the following units.  
38-1436HD 38-1436WD

### RESILIENCE LAMINATE OFFERING

Indiana Furniture has partnered with Pionite Decorative Laminates and Wilsonart International to provide a Customer Specified Laminate program.

- CSL can be specified for worksurfaces only. Chassis colors cannot be requested.
- Laminate sheen level not to exceed 60° for maximum durability of worksurfaces.
- Indiana Furniture reserves the right to decline a laminate which may not be suitable for application.
- Indiana Furniture assumes no responsibility for the durability, consistent coloration or any other performance characteristic of a customer specified laminate.
- Contact Customer Service with product list and specific laminate information to obtain a quote for pricing and leadtime.

Pionite®  
Decorative Laminates

WILSONART  
INTERNATIONAL

CALL 1.800.PIONITE FOR SAMPLES

CALL 1.800.433.3222 FOR SAMPLES

Add 3.75% List Price Increase Effective May 1, 2011

**NOTE: STANDARD OPTIONS ON THIS PAGE MAY REQUIRE ADDITIONAL LEAD TIME.**  
Call Customer Service for specific availability and lead time.

Item	Model No.	Description	Dimensions	List Price
EXECUTIVE DOUBLE PEDESTAL DESK - BOW TOP STEPPED FRONT	38-4272DP1	<ul style="list-style-type: none"> <li>• Bow Top</li> <li>• Stepped Front</li> <li>• Locking Pedestals</li> <li>• Legal Width Pedestals</li> <li>• Box/Box/File in Left Pedestal</li> <li>• File/File in Right Pedestal</li> </ul>	Width 72 Depth 42-36 Height 30 Kneespace 36 Ship Wt. 405 Cubic Ft. 57.94	\$2554

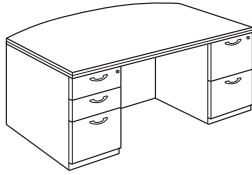

EXECUTIVE DOUBLE PEDESTAL DESK - BOW TOP STEPPED FRONT	38-4272DP2	<ul style="list-style-type: none"> <li>• Bow Top</li> <li>• Stepped Front</li> <li>• Locking Pedestals</li> <li>• Legal Width Pedestals</li> <li>• File/File in Left Pedestal</li> <li>• Box/Box/File in Right Pedestal</li> </ul>	Width 72 Depth 42-36 Height 30 Kneespace 36 Ship Wt. 405 Cubic Ft. 57.94	\$2554
--	------------	--	---	--------

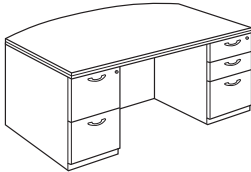

EXECUTIVE DOUBLE PEDESTAL DESK - BOW TOP STEPPED FRONT	38-4272DP4	<ul style="list-style-type: none"> <li>• Bow Top</li> <li>• Stepped Front</li> <li>• Locking Pedestals</li> <li>• Legal Width Pedestals</li> <li>• Box/Box/File in Left Pedestal</li> <li>• Box/Box/File in Right Pedestal</li> </ul>	Width 72 Depth 42-36 Height 30 Kneespace 36 Ship Wt. 405 Cubic Ft. 57.94	\$2554
--	------------	---	---	--------

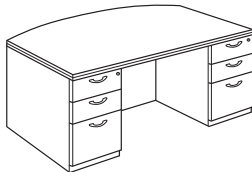

**How To Order:**

38 - 4272DP1 - SM - CN - K - MBA  
 | | | | | |  
 Series Model # Chassis Top Edge Pull

For ordering options, see page 121.

For grommet options, see page 122.

For center drawer options, see page 153.

**Resilience**



Add 3.75% List Price Increase Effective May 1, 2011

Item	Model No.	Description	Dimensions	List Price
EXECUTIVE DOUBLE PEDESTAL DESK STEPPED FRONT	38-3672DP1	<ul style="list-style-type: none"> <li>• Stepped Front</li> <li>• Locking Pedestals</li> <li>• Legal Width Pedestals</li> <li>• Box/Box/File in Left Pedestal</li> <li>• File/File in Right Pedestal</li> </ul>	Width 72 Depth 36 Height 30 Kneespace 36 Ship Wt. 400 Cubic Ft. 50.04	\$2362

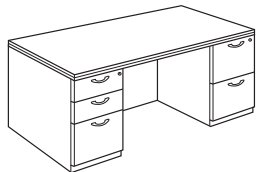

EXECUTIVE DOUBLE PEDESTAL DESK STEPPED FRONT	38-3672DP2	<ul style="list-style-type: none"> <li>• Stepped Front</li> <li>• Locking Pedestals</li> <li>• Legal Width Pedestals</li> <li>• File/File in Left Pedestal</li> <li>• Box/Box/File in Right Pedestal</li> </ul>	Width 72 Depth 36 Height 30 Kneespace 36 Ship Wt. 400 Cubic Ft. 50.04	\$2362
--	------------	---	--	--------

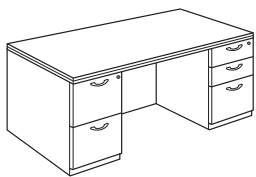

EXECUTIVE DOUBLE PEDESTAL DESK STEPPED FRONT	38-3672DP4	<ul style="list-style-type: none"> <li>• Stepped Front</li> <li>• Locking Pedestals</li> <li>• Legal Width Pedestals</li> <li>• Box/Box/File in Left Pedestal</li> <li>• Box/Box/File in Right Pedestal</li> </ul>	Width 72 Depth 36 Height 30 Kneespace 36 Ship Wt. 400 Cubic Ft. 50.04	\$2362
--	------------	--	--	--------

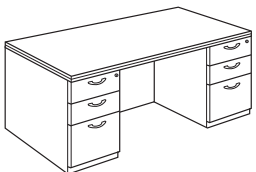

**How To Order:**

38 - 3672DP1 - SM - CN - K - MBA  
 | | | | |  
 Series Model # Chassis Top Edge Pull

For ordering options, see page 121.

For grommet options, see page 122.

For center drawer options, see page 153.

Add 3.75% List Price Increase Effective May 1, 2011

Item	Model No.	Description	Dimensions	List Price
EXECUTIVE DOUBLE PEDESTAL DESK STEPPED FRONT	38-3066DP1	<ul style="list-style-type: none"> <li>• Stepped Front</li> <li>• Locking Pedestals</li> <li>• Legal Width Pedestals</li> <li>• Box/Box/File in Left Pedestal</li> <li>• File/File in Right Pedestal</li> </ul>	Width 66 Depth 30 Height 30 Kneespace 30 Ship Wt. 365 Cubic Ft. 38.72	\$2254

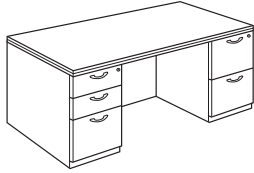

EXECUTIVE DOUBLE PEDESTAL DESK STEPPED FRONT	38-3066DP2	<ul style="list-style-type: none"> <li>• Stepped Front</li> <li>• Locking Pedestals</li> <li>• Legal Width Pedestals</li> <li>• File/File in Left Pedestal</li> <li>• Box/Box/File in Right Pedestal</li> </ul>	Width 66 Depth 30 Height 30 Kneespace 30 Ship Wt. 365 Cubic Ft. 38.72	\$2254
--	------------	---	--	--------

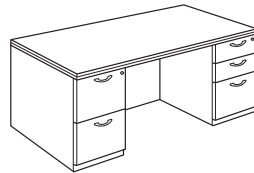

EXECUTIVE DOUBLE PEDESTAL DESK STEPPED FRONT	38-3066DP4	<ul style="list-style-type: none"> <li>• Stepped Front</li> <li>• Locking Pedestals</li> <li>• Legal Width Pedestals</li> <li>• Box/Box/File in Left Pedestal</li> <li>• Box/Box/File in Right Pedestal</li> </ul>	Width 66 Depth 30 Height 30 Kneespace 30 Ship Wt. 365 Cubic Ft. 38.72	\$2254
--	------------	--	--	--------

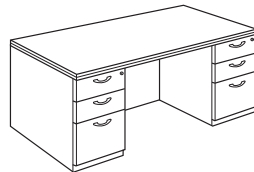

**How To Order:**

38 - 3066DP1 - SM - CN - K - MBA  
 |        |        |        |        |        |  
 Series Model # Chassis Top Edge Pull

For ordering options, see page 121.

For grommet options, see page 122.

For center drawer options, see page 153.

**Resilience**

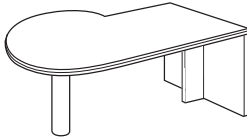

Add 3.75% List Price Increase Effective May 1, 2011

Item	Model No.	Description	Dimensions	List Price
LEFT P-TOP WITH END SUPPORT/ CYLINDER BASE/ MODESTY PANEL 	38-4272PL	<ul style="list-style-type: none"> <li>• End Panel Support</li> <li>• Modesty Panel - 10"</li> <li>• Black Metal</li> <li>Base - 4" Diameter</li> </ul>	Width 72 Depth 42-36 Height 30 Ship Wt. 173 Cubic Ft. 57.94	\$1518
	38-HMD	• Optional Half Modesty Panel		Specify & Add: \$ 50
	38-FMD	• Optional Full Modesty Panel		Specify & Add: \$ 95
	38-ALEG	• Optional Aluminum Cylinder Base		Specify & Add: \$ N/C

NOTE: For center drawer option, use 38-1622CD on page 153.  
 NOTE: Not Recommended for freestanding use.

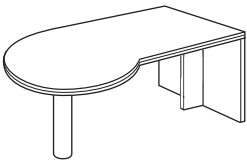
RIGHT P-TOP WITH END SUPPORT/ CYLINDER BASE/ MODESTY PANEL 	38-4272PR	<ul style="list-style-type: none"> <li>• End Panel Support</li> <li>• Modesty Panel - 10"</li> <li>• Black Metal</li> <li>Base - 4" Diameter</li> </ul>	Width 72 Depth 42-36 Height 30 Ship Wt. 173 Cubic Ft. 57.94	\$1518
	38-HMD	• Optional Half Modesty Panel		Specify & Add: \$ 50
	38-FMD	• Optional Full Modesty Panel		Specify & Add: \$ 95
	38-ALEG	• Optional Aluminum Cylinder Base		Specify & Add: \$ N/C

NOTE: For center drawer option, use 38-1622CD on page 153.  
 NOTE: Not Recommended for freestanding use.

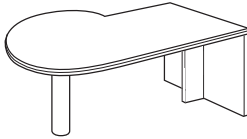
LEFT P-TOP WITH END SUPPORT/ CYLINDER BASE/ MODESTY PANEL 	38-3672PL	<ul style="list-style-type: none"> <li>• End Panel Support</li> <li>• Modesty Panel - 10"</li> <li>• Black Metal</li> <li>Base - 4" Diameter</li> </ul>	Width 72 Depth 36-30 Height 30 Ship Wt. 170 Cubic Ft. 50.04	\$1416
	38-HMD	• Optional Half Modesty Panel		Specify & Add: \$ 50
	38-FMD	• Optional Full Modesty Panel		Specify & Add: \$ 95
	38-ALEG	• Optional Aluminum Cylinder Base		Specify & Add: \$ N/C

NOTE: Due to modesty panel, center drawer and keyboard options are not applicable.  
 NOTE: Not Recommended for freestanding use.

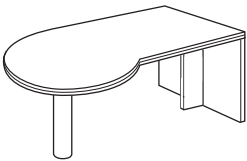
RIGHT P-TOP WITH END SUPPORT/ CYLINDER BASE/ MODESTY PANEL 	38-3672PR	<ul style="list-style-type: none"> <li>• End Panel Support</li> <li>• Modesty Panel - 10"</li> <li>• Black Metal</li> <li>Base - 4" Diameter</li> </ul>	Width 72 Depth 36-30 Height 30 Ship Wt. 170 Cubic Ft. 50.04	\$1416
	38-HMD	• Optional Half Modesty Panel		Specify & Add: \$ 50
	38-FMD	• Optional Full Modesty Panel		Specify & Add: \$ 95
	38-ALEG	• Optional Aluminum Cylinder Base		Specify & Add: \$ N/C

NOTE: Due to modesty panel, center drawer and keyboard options are not applicable.  
 NOTE: Not Recommended for freestanding use.

**How To Order:**

38 - 4272PL - SM - CN - K  
 | | | | |  
 Series Model # Chassis Top Edge

For ordering options, see page 121.

For grommet options, see page 122.

For center drawer options, see page 153.

Add 3.75% List Price Increase Effective May 1, 2011

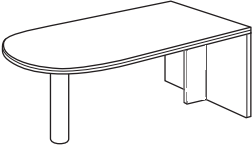
Item	Model No.	Description	Dimensions	List Price
D-TOP WITH END SUPPORT/ CYLINDER BASE/ MODESTY PANEL  	38-3672DU	<ul style="list-style-type: none"> <li>D-Top</li> <li>End Panel Support</li> <li>Modesty Panel - 10"</li> <li>Black Metal</li> <li>Base - 4" Diameter</li> </ul>	Width 72 Depth 36 Height 30 Ship Wt. 170 Cubic Ft. 50.04	\$1308
	38-HMD	• Optional Half Modesty Panel		Specify & Add: \$ 50
	38-FMD	• Optional Full Modesty Panel		Specify & Add: \$ 95
	38-ALEG	• Optional Aluminum Cylinder Base		Specify & Add: \$ N/C
	NOTE: For center drawer option, use 38-1622CD on page 153. NOTE: Kneespace options can not be factory installed. NOTE: Not Recommended for freestanding use.			

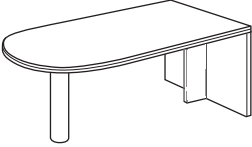
D-TOP WITH END SUPPORT/ CYLINDER BASE/ MODESTY PANEL  	38-3072DU	<ul style="list-style-type: none"> <li>D-Top</li> <li>End Panel Support</li> <li>Modesty Panel - 10"</li> <li>Black Metal</li> <li>Base - 4" Diameter</li> </ul>	Width 72 Depth 30 Height 30 Ship Wt. 165 Cubic Ft. 42.14	\$1188
	38-HMD	• Optional Half Modesty Panel		Specify & Add: \$ 50
	38-FMD	• Optional Full Modesty Panel		Specify & Add: \$ 95
	38-ALEG	• Optional Aluminum Cylinder Base		Specify & Add: \$ N/C
	NOTE: Due to modesty panel, center drawer and keyboard options are not applicable. NOTE: Not Recommended for freestanding use.			

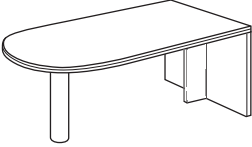
D-TOP WITH END SUPPORT/ CYLINDER BASE/ MODESTY PANEL  	38-3066DU	<ul style="list-style-type: none"> <li>D-Top</li> <li>End Panel Support</li> <li>Modesty Panel - 10"</li> <li>Black Metal</li> <li>Base - 4" Diameter</li> </ul>	Width 66 Depth 30 Height 30 Ship Wt. 165 Cubic Ft. 38.72	\$1134
	38-HMD	• Optional Half Modesty Panel		Specify & Add: \$ 50
	38-FMD	• Optional Full Modesty Panel		Specify & Add: \$ 85
	38-ALEG	• Optional Aluminum Cylinder Base		Specify & Add: \$ N/C
	NOTE: Due to modesty panel, center drawer and keyboard options are not applicable. NOTE: Not Recommended for freestanding use.			

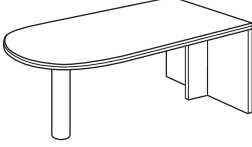
D-TOP WITH END SUPPORT/ CYLINDER BASE/ MODESTY PANEL  	38-3060DU	<ul style="list-style-type: none"> <li>D-Top</li> <li>End Panel Support</li> <li>Modesty Panel - 10"</li> <li>Black Metal</li> <li>Base - 4" Diameter</li> </ul>	Width 60 Depth 30 Height 30 Ship Wt. 135 Cubic Ft. 35.31	\$1085
	38-HMD	• Optional Half Modesty Panel		Specify & Add: \$ 45
	38-FMD	• Optional Full Modesty Panel		Specify & Add: \$ 75
	38-ALEG	• Optional Aluminum Cylinder Base		Specify & Add: \$ N/C
	NOTE: Due to modesty panel, center drawer and keyboard options are not applicable. NOTE: Not Recommended for freestanding use.			

**How To Order:**

38 - 3672DU - SM - CN - K  
 | | | | |  
 Series Model # Chassis Top Edge

For ordering options, see page 121.  
 For grommet options, see page 122.  
 For center drawer options, see page 153.

**Resilience**  
 GREENGUARD  
 Add 3.75% List Price Increase Effective May 1, 2011

Item	Model No.	Description	Dimensions	List Price
EXECUTIVE LEFT PEDESTAL DESK - BOW TOP STEPPED FRONT	38-4272LP1	<ul style="list-style-type: none"> <li>• Bow Top</li> <li>• Stepped Front</li> <li>• Locking Pedestal</li> <li>• Legal Width Pedestal</li> <li>• Box/Box/File in Pedestal</li> </ul>	Width 72 Depth 42-36 Height 30 Kneespace 30 Ship Wt. 340 Cubic Ft. 57.94	\$2158

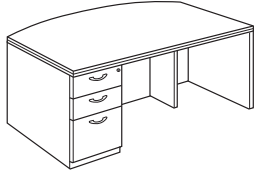

**Resilience**



EXECUTIVE RIGHT PEDESTAL DESK - BOW TOP STEPPED FRONT	38-4272RP1	<ul style="list-style-type: none"> <li>• Bow Top</li> <li>• Stepped Front</li> <li>• Locking Pedestal</li> <li>• Legal Width Pedestal</li> <li>• Box/Box/File in Pedestal</li> </ul>	Width 72 Depth 42-36 Height 30 Kneespace 30 Ship Wt. 340 Cubic Ft. 57.94	\$2158
---	------------	--	---	--------

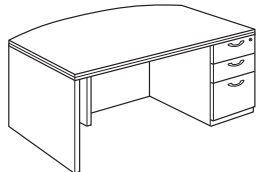

**How To Order:**

38 - 4272RP1 - SM - CN - K - MBA  
 |           |           |           |           |  
 Series   Model #   Chassis   Top   Edge   Pull

**For ordering options, see page 121.**

**For grommet options, see page 122.**

**For center drawer options, see page 153.**

**Add 3.75% List Price Increase Effective May 1, 2011**

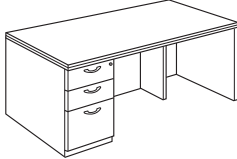
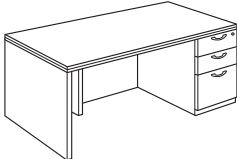
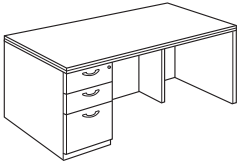
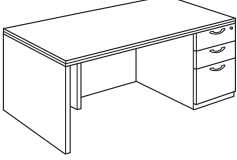
Item	Model No.	Description	Dimensions	List Price
EXECUTIVE LEFT PEDESTAL DESK STEPPED FRONT	38-3672LP1	<ul style="list-style-type: none"> <li>• Stepped Front</li> <li>• Locking Pedestal</li> <li>• Legal Width Pedestal</li> <li>• Box/Box/File in Pedestal</li> </ul>	Width 72 Depth 36 Height 30 Kneespace 30 Ship Wt. 270 Cubic Ft. 51.7	\$1877
				
EXECUTIVE RIGHT PEDESTAL DESK STEPPED FRONT	38-3672RP1	<ul style="list-style-type: none"> <li>• Stepped Front</li> <li>• Locking Pedestal</li> <li>• Legal Width Pedestal</li> <li>• Box/Box/File in Pedestal</li> </ul>	Width 72 Depth 36 Height 30 Kneespace 30 Ship Wt. 270 Cubic Ft. 51.7	\$1877
				
EXECUTIVE LEFT PEDESTAL DESK STEPPED FRONT	38-3066LP1	<ul style="list-style-type: none"> <li>• Stepped Front</li> <li>• Locking Pedestal</li> <li>• Legal Width Pedestal</li> <li>• Box/Box/File in Pedestal</li> </ul>	Width 66 Depth 30 Height 30 Kneespace 24 Ship Wt. 240 Cubic Ft. 38.72	\$1764
				
EXECUTIVE RIGHT PEDESTAL DESK STEPPED FRONT	38-3066RP1	<ul style="list-style-type: none"> <li>• Stepped Front</li> <li>• Locking Pedestal</li> <li>• Legal Width Pedestal</li> <li>• Box/Box/File in Pedestal</li> </ul>	Width 66 Depth 30 Height 30 Kneespace 24 Ship Wt. 240 Cubic Ft. 38.72	\$1764
				

**How To Order:**

38 - 3672LP1 - SM - CN - K - MBA  
 | | | | | |  
 Series Model # Chassis Top Edge Pull

For ordering options, see page 121.  
 For grommet options, see page 122.  
 For center drawer options, see page 153.

**Resilience**  
  
 Add 3.75% List Price Increase Effective May 1, 2011

Item	Model No.	Description	Dimensions	List Price
EXECUTIVE LEFT COCKPIT DESK - BOW TOP	38-4278CLP1	<ul style="list-style-type: none"> <li>• Bow Top</li> <li>• Legal Width Pedestal</li> <li>• Box/Box/File in Pedestal</li> <li>• Locking Pedestal</li> </ul>	Width 78 Depth 42-36 Height 30 Kneespace 36 Ship Wt. 350 Cubic Ft. 62.64	\$2309

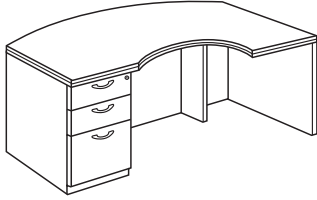

NOTE: Tops are non reconfigurable.

EXECUTIVE RIGHT COCKPIT DESK - BOW TOP	38-4278CRP1	<ul style="list-style-type: none"> <li>• Bow Top</li> <li>• Legal Width Pedestal</li> <li>• Box/Box/File in Pedestal</li> <li>• Locking Pedestal</li> </ul>	Width 78 Depth 42-36 Height 30 Kneespace 36 Ship Wt. 350 Cubic Ft. 62.64	\$2309
---	-------------	---	---	--------

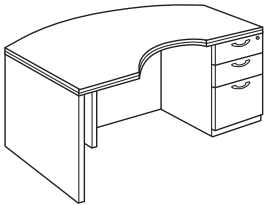

NOTE: Tops are non reconfigurable.

**How To Order:**

38 - 4278CRP1 - SM - CN - K - MBA  
 |           |           |           |           |  
 Series   Model #   Chassis   Top   Edge   Pull

For ordering options, see page 121.

For grommet options, see page 122.

Add 3.75% List Price Increase Effective May 1, 2011

Item	Model No.	Description	Dimensions	List Price
EXECUTIVE LEFT COCKPIT SHELL DESK	38-4278CLSH	<ul style="list-style-type: none"> <li>• Bow Top</li> <li>• Desk Shell</li> </ul>	Width 78 Depth 42-36 Height 30 Kneespace 54 Ship Wt. 260 Cubic Ft. 62.64	\$1866

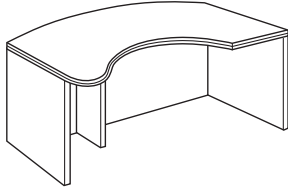

NOTE: Tops are non reconfigurable.

EXECUTIVE RIGHT COCKPIT SHELL DESK	38-4278CRSH	<ul style="list-style-type: none"> <li>• Bow Top</li> <li>• Desk Shell</li> </ul>	Width 78 Depth 42-36 Height 30 Kneespace 54 Ship Wt. 260 Cubic Ft. 62.64	\$1866
---------------------------------------	-------------	---	---	--------

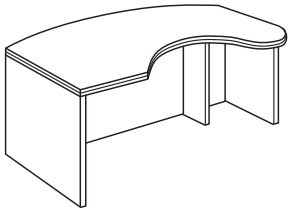

NOTE: Tops are non reconfigurable.

**How To Order:**

38 - 4278CRSH - SM - CN - K  
 |           |           |           |           |  
 Series   Model #   Chassis   Top   Edge

For ordering options, see page 121.

For grommet options, see page 122.

**Resilience**



Add 3.75% List Price Increase Effective May 1, 2011

Item	Model No.	Description	Dimensions		List Price
Cockpit Bridge Unit	38-2420CUF	<ul style="list-style-type: none"> <li>Grommet in Back Panel</li> </ul>	Width	20	\$ 539
			Depth	24	
			Height	30	
			Ship Wt.	60	
			Cubic Ft.	2.31	

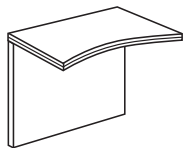

NOTE: Also available with half modesty panel. Please specify 38-2420CUFH at \$505 list.  
NOTE: Kneespace options are not applicable.

Cockpit Corner Unit	38-3636CCU	<ul style="list-style-type: none"> <li>Freestanding Support Unit</li> <li>Connects to 24" Deep Bridge Units and Executive Height Returns</li> <li>Grommet in Top</li> </ul>	Width	36	\$ 958
			Depth	36	
			Height	30	
			Diagonal Sit	22 <sup>5</sup> / <sub>8</sub>	
			Diagonal Top	17	
			Ship Wt.	135	
			Cubic Ft.	25.70	

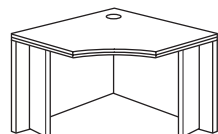

NOTE: Not all keyboards will fit this unit. Recommended keyboards are 1-KCWR, 1-KCPR and 1-KC; see pages 594-595.

**How To Order:**

38 - 3636CCU - SM - CN - K  
 | | | | |  
 Series Model # Chassis Top Edge

**For ordering options, see page 121.**

**For computer keyboard options, see pages 594-595.**

Add 3.75% List Price Increase Effective May 1, 2011

Item	Model No.	Description	Dimensions	List Price
COCKPIT LEFT RETURN	38-2442CLF1	<ul style="list-style-type: none"> <li>• Legal Width Pedestal</li> <li>• Box/Box/File in Pedestal</li> <li>• Locking Pedestal</li> <li>• Grommet in Back Panel</li> </ul>	Width 42 Depth 24 Height 30 Kneespace 24 Ship Wt. 150 Cubic Ft. 24.2	\$1410

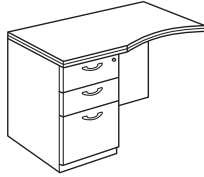

NOTE: Tops are non reconfigurable.

COCKPIT RIGHT RETURN	38-2442CRF1	<ul style="list-style-type: none"> <li>• Legal Width Pedestal</li> <li>• Box/Box/File in Pedestal</li> <li>• Locking Pedestal</li> <li>• Grommet in Back Panel</li> </ul>	Width 42 Depth 24 Height 30 Kneespace 24 Ship Wt. 150 Cubic Ft. 24.2	\$1410
----------------------	-------------	---	---	--------

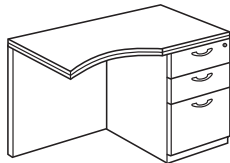

NOTE: Tops are non reconfigurable.

COCKPIT LEFT RETURN	38-2442CLF2	<ul style="list-style-type: none"> <li>• Locking Pedestal</li> <li>• Legal Width Pedestal</li> <li>• File/File in Pedestal</li> <li>• Grommet in Back Panel</li> </ul>	Width 42 Depth 24 Height 30 Kneespace 24 Ship Wt. 150 Cubic Ft. 24.2	\$1410
---------------------	-------------	--	---	--------

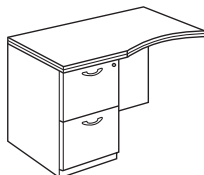

NOTE: Tops are non reconfigurable.

COCKPIT RIGHT RETURN	38-2442CRF2	<ul style="list-style-type: none"> <li>• Locking Pedestal</li> <li>• Legal Width Pedestal</li> <li>• File/File in Pedestal</li> <li>• Grommet in Back Panel</li> </ul>	Width 42 Depth 24 Height 24 Kneespace 24 Ship Wt. 150 Cubic Ft. 24.2	\$1410
----------------------	-------------	--	---	--------

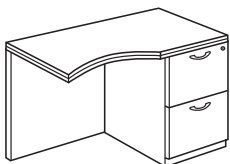

NOTE: Tops are non reconfigurable.

**How To Order:**

38 - 2442CRF2 - SM - CN - K - MBA  
 |           |           |           |           |  
 Series   Model #   Chassis   Top   Edge   Pull

For ordering options, see page 121.

For grommet options, see page 122.

For computer keyboard options, see pages 594-595.

**Resilience**  
**GREENGUARD**

Add 3.75% List Price Increase Effective May 1, 2011

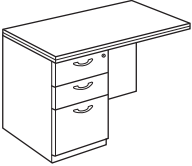
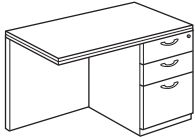
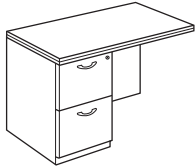
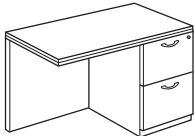
Item	Model No.	Description	Dimensions	List Price
EXECUTIVE LEFT RETURN	38-2448LF1	<ul style="list-style-type: none"> <li>• Locking Pedestal</li> <li>• Legal Width Pedestal</li> <li>• Box/Box/File in Pedestal</li> <li>• Grommet in Back Panel</li> </ul>	Width 48 Depth 24 Height 30 Kneespace 30 Ship Wt. 150 Cubic Ft. 24.2	\$1337
				
EXECUTIVE RIGHT RETURN	38-2448RF1	<ul style="list-style-type: none"> <li>• Locking Pedestal</li> <li>• Legal Width Pedestal</li> <li>• Box/Box/File in Pedestal</li> <li>• Grommet in Back Panel</li> </ul>	Width 48 Depth 24 Height 30 Kneespace 30 Ship Wt. 150 Cubic Ft. 24.2	\$1337
				
EXECUTIVE LEFT RETURN	38-2448LF2	<ul style="list-style-type: none"> <li>• Locking Pedestal</li> <li>• Legal Width Pedestal</li> <li>• File/File in Pedestal</li> <li>• Grommet in Back Panel</li> </ul>	Width 48 Depth 24 Height 30 Kneespace 30 Ship Wt. 150 Cubic Ft. 24.2	\$1337
				
EXECUTIVE RIGHT RETURN	38-2448RF2	<ul style="list-style-type: none"> <li>• Locking Pedestal</li> <li>• Legal Width Pedestal</li> <li>• File/File in Pedestal</li> <li>• Grommet in Back Panel</li> </ul>	Width 48 Depth 24 Height 30 Kneespace 30 Ship Wt. 150 Cubic Ft. 24.2	\$1337
				

**Resilience**



**How To Order:**

38 - 2448RF2 - SM - CN - K - MBA  
 |           |           |           |           |           |  
 Series   Model #   Chassis   Top   Edge   Pull

For ordering options, see page 121.

For grommet options, see page 122.

For computer keyboard options, see pages 594-595.

Add 3.75% List Price Increase Effective May 1, 2011

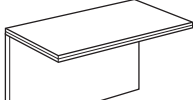
Item	Model No.	Description	Dimensions	List Price
EXECUTIVE BRIDGE UNIT 	38-2448UF	<ul style="list-style-type: none"> <li>• Bridge Unit</li> <li>• Grommet in Back Panel</li> </ul>	Width 48 Depth 24 Height 30 Ship Wt. 78 Cubic Ft. 5.25	\$ 689

NOTE: Also available with half modesty panel. Please specify 38-2448UFH at \$600 list.  
NOTE: Kneespace options can not be factory installed.

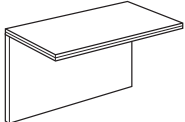
EXECUTIVE BRIDGE UNIT 	38-2442UF	<ul style="list-style-type: none"> <li>• Bridge Unit</li> <li>• Grommet in Back Panel</li> </ul>	Width 42 Depth 24 Height 30 Ship Wt. 74 Cubic Ft. 4.62	\$ 654
--	-----------	--	--	--------

NOTE: Also available with half modesty panel. Please specify 38-2442UFH at \$585 list.  
NOTE: Kneespace options can not be factory installed.

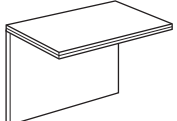
EXECUTIVE BRIDGE UNIT 	38-2436UF	<ul style="list-style-type: none"> <li>• Bridge Unit</li> <li>• Grommet in Back Panel</li> </ul>	Width 36 Depth 24 Height 30 Ship Wt. 68 Cubic Ft. 3.99	\$ 594
--	-----------	--	--	--------

NOTE: Also available with half modesty panel. Please specify 38-2436UFH at \$525 list.  
NOTE: Kneespace options can not be factory installed.

**How To Order:**

38 - 2436UF - SM - CN - K  
 |        |        |        |        |  
 Series Model # Chassis Top Edge

For ordering options, see page 121.

For grommet options, see page 122.

For computer keyboard options, see pages 594-595.

**Resilience**

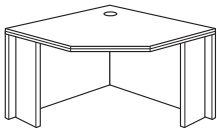

Add 3.75% List Price Increase Effective May 1, 2011

Item	Model No.	Description	Dimensions	List Price
CORNER UNIT 	38-4242CU	<ul style="list-style-type: none"> <li>Freestanding Support Unit</li> <li>Connects to 24" Deep Bridge Units, Executive Returns, and Component Worksurfaces</li> <li>Grommet in Top</li> </ul>	Width 42 Depth 42 Height 30 Diagonal Sit 29 <sup>3</sup> / <sub>16</sub> Diagonal Top 25 1/2 Ship Wt. 145 Cubic Ft. 34.45	\$1129

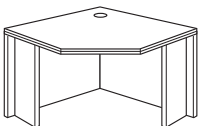
CORNER UNIT 	38-3636CU	<ul style="list-style-type: none"> <li>Freestanding Support Unit</li> <li>Connects to 24" Deep Bridge Units, Executive Returns, and Component Worksurfaces</li> <li>Grommet in Top</li> </ul>	Width 36 Depth 36 Height 30 Diagonal Sit 20 <sup>11</sup> / <sub>16</sub> Diagonal Top 17 Ship Wt. 115 Cubic Ft. 26.8	\$ 900
--	-----------	---	---	--------

NOTE: Not all keyboards will fit this unit. Recommended keyboards are 1-KCWR, 1-KCPR and 1-KC; see pages 594-595.

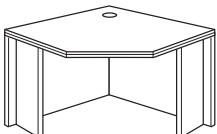
CORNER UNIT 	38-424230CU	<ul style="list-style-type: none"> <li>Freestanding Support Unit</li> <li>Connects to 30" Deep Component Worksurfaces</li> <li>Grommet in Top</li> </ul>	Width 42 Depth 42 Height 30 Diagonal Sit 29 <sup>3</sup> / <sub>16</sub> Diagonal Top 17 Ship Wt. 145 Cubic Ft. 34.45	\$1259
--	-------------	--	---	--------

NOTE: Not all keyboards will fit this unit. Recommended keyboards are 1-KCWR, 1-KCPR and 1-KC; see pages 594-595.

**How To Order:**

38 - 3636CU - SM - CN - K  
 | | | | |  
 Series Model # Chassis Top Edge

For ordering options, see page 121.

For computer keyboard options, see pages 594-595.

Add 3.75% List Price Increase Effective May 1, 2011

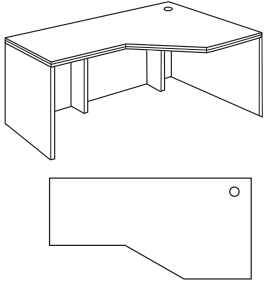
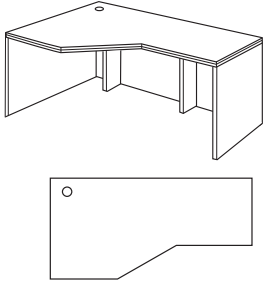
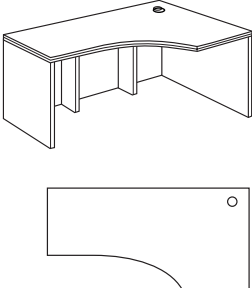
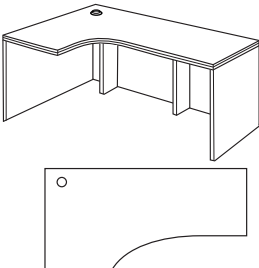
Item	Model No.	Description	Dimensions		List Price
EXTENDED CORNER - ANGLED	38-3672ECL	<ul style="list-style-type: none"> <li>Connects to 24" Deep Component Worksurfaces and Returns</li> <li>Grommet in Top</li> </ul>	Width	72	\$1391
	Depth	36-24			
	Height	30			
	Ship Wt.	203			
	Cubic Ft.	50.04			
EXTENDED CORNER - ANGLED	38-3672ECR	<ul style="list-style-type: none"> <li>Connects to 24" Deep Component Worksurfaces and Returns</li> <li>Grommet in Top</li> </ul>	Width	72	\$1391
	Depth	36-24			
	Height	30			
	Ship Wt.	203			
	Cubic Ft.	50.04			
EXTENDED CORNER - COCKPIT	38-3672ECL1	<ul style="list-style-type: none"> <li>Connects to 24" Deep Component Worksurfaces and Returns</li> <li>Grommet in Top</li> </ul>	Width	72	\$1391
	Depth	36-24			
	Height	30			
	Ship Wt.	203			
	Cubic Ft.	50.04			
EXTENDED CORNER - COCKPIT	38-3672ECR1	<ul style="list-style-type: none"> <li>Connects to 24" Deep Component Worksurfaces and Returns</li> <li>Grommet in Top</li> </ul>	Width	72	\$1391
	Depth	36-24			
	Height	30			
	Ship Wt.	203			
	Cubic Ft.	50.04			

**How To Order:**

38 - 3672ECL1 - SM - CN - K  
 |        |        |        |        |  
 Series Model # Chassis Top Edge

For ordering options, see page 121.

For computer keyboard options, see pages 594-595.

**Resilience**



Add 3.75% List Price Increase Effective May 1, 2011

Item	Model No.	Description	Dimensions	List Price
LEFT PEDESTAL CREDENZA	38-2472LC1	<ul style="list-style-type: none"> <li>• Locking Pedestal</li> <li>• Legal Width Pedestal</li> <li>• Box/Box/File in Pedestal</li> <li>• Grommet in Back Panel</li> </ul>	Width 72 Depth 24 Height 30 Kneespace 30 Ship Wt. 240 Cubic Ft. 35.6	\$1596



RIGHT PEDESTAL CREDENZA	38-2472RC1	<ul style="list-style-type: none"> <li>• Locking Pedestal</li> <li>• Legal Width Pedestal</li> <li>• Box/Box/File in Pedestal</li> <li>• Grommet in Back Panel</li> </ul>	Width 72 Depth 24 Height 30 Kneespace 30 Ship Wt. 240 Cubic Ft. 35.6	\$1596
-------------------------	------------	---	---	--------

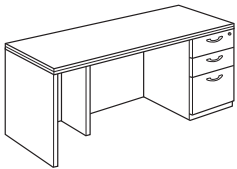

LEFT PEDESTAL CREDENZA	38-2472LC2	<ul style="list-style-type: none"> <li>• Locking Pedestal</li> <li>• Legal Width Pedestal</li> <li>• File/File in Pedestal</li> <li>• Grommet in Back Panel</li> </ul>	Width 72 Depth 24 Height 30 Kneespace 30 Ship Wt. 240 Cubic Ft. 35.6	\$1596
------------------------	------------	--	---	--------



RIGHT PEDESTAL CREDENZA	38-2472RC2	<ul style="list-style-type: none"> <li>• Locking Pedestal</li> <li>• Legal Width Pedestal</li> <li>• File/File in Pedestal</li> <li>• Grommet in Back Panel</li> </ul>	Width 72 Depth 24 Height 30 Kneespace 30 Ship Wt. 240 Cubic Ft. 35.6	\$1596
-------------------------	------------	--	---	--------

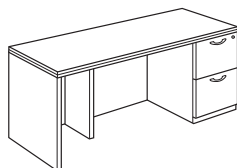

**How To Order:**

38 - 2472RC2 - SM - CN - K - MBA  
 |           |           |           |           |           |  
 Series   Model #   Chassis   Top   Edge   Pull

For ordering options, see page 121.

For grommet options, see page 122.

For computer keyboard options, see pages 594-595.

Add 3.75% List Price Increase Effective May 1, 2011

Item	Model No.	Description	Dimensions	List Price
LEFT PEDESTAL CREENZA	38-2466LC1	<ul style="list-style-type: none"> <li>• Locking Pedestal</li> <li>• Legal Width Pedestal</li> <li>• Box/Box/File in Pedestal</li> <li>• Grommet in Back Panel</li> </ul>	Width 66 Depth 24 Height 30 Kneespace 24 Ship Wt. 230 Cubic Ft. 31.46	\$1566



RIGHT PEDESTAL CREENZA	38-2466RC1	<ul style="list-style-type: none"> <li>• Locking Pedestal</li> <li>• Legal Width Pedestal</li> <li>• Box/Box/File in Pedestal</li> <li>• Grommet in Back Panel</li> </ul>	Width 66 Depth 24 Height 30 Kneespace 24 Ship Wt. 230 Cubic Ft. 31.46	\$1566
------------------------	------------	---	--	--------

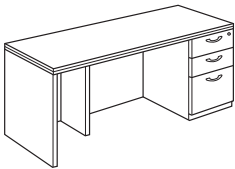

LEFT PEDESTAL CREENZA	38-2466LC2	<ul style="list-style-type: none"> <li>• Locking Pedestal</li> <li>• Legal Width Pedestal</li> <li>• File/File in Pedestal</li> <li>• Grommet in Back Panel</li> </ul>	Width 66 Depth 24 Height 30 Kneespace 24 Ship Wt. 230 Cubic Ft. 31.46	\$1566
-----------------------	------------	--	--	--------



RIGHT PEDESTAL CREENZA	38-2466RC2	<ul style="list-style-type: none"> <li>• Locking Pedestal</li> <li>• Legal Width Pedestal</li> <li>• File/File in Pedestal</li> <li>• Grommet in Back Panel</li> </ul>	Width 66 Depth 24 Height 30 Kneespace 24 Ship Wt. 230 Cubic Ft. 31.46	\$1566
------------------------	------------	--	--	--------

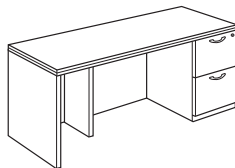

**How To Order:**

38 - 2466LC2 - SM - CN - K - MBA  
 |        |        |        |        |        |  
 Series Model # Chassis Top Edge Pull

For ordering options, see page 121.



For grommet options, see page 122.

For computer keyboard options, see pages 594-595.

**Resilience**

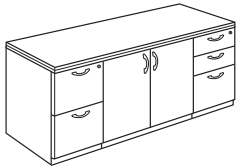

Add 3.75% List Price Increase Effective May 1, 2011

Item	Model No.	Description	Dimensions	List Price
STORAGE CREDENZA	38-2472SC1	<ul style="list-style-type: none"> <li>• Locking Pedestals</li> <li>• Legal Width Pedestals</li> <li>• Adjustable Shelf Behind Doors</li> <li>• Box/Box/File in Left Pedestal</li> <li>• File/File in Right Pedestal</li> </ul>	Width 72 Depth 24 Height 30 Ship Wt. 335 Cubic Ft. 35.6	\$2723
				
STORAGE CREDENZA	38-2472SC2	<ul style="list-style-type: none"> <li>• Locking Pedestals</li> <li>• Legal Width Pedestals</li> <li>• Adjustable Shelf Behind Doors</li> <li>• File/File in Left Pedestal</li> <li>• Box/Box/File in Right Pedestal</li> </ul>	Width 72 Depth 24 Height 30 Ship Wt. 335 Cubic Ft. 35.6	\$2723
				
STORAGE CREDENZA	38-2472SC3	<ul style="list-style-type: none"> <li>• Locking Pedestals</li> <li>• Legal Width Pedestals</li> <li>• Adjustable Shelf Behind Doors</li> <li>• File/File in Left Pedestal</li> <li>• File/File in Right Pedestal</li> </ul>	Width 72 Depth 24 Height 30 Ship Wt. 335 Cubic Ft. 35.6	\$2723
				
STORAGE CREDENZA	38-2472SC4	<ul style="list-style-type: none"> <li>• Locking Pedestals</li> <li>• Legal Width Pedestals</li> <li>• Adjustable Shelf Behind Doors</li> <li>• Box/Box/File in Left Pedestal</li> <li>• Box/Box/File in Right Pedestal</li> </ul>	Width 72 Depth 24 Height 30 Ship Wt. 335 Cubic Ft. 35.6	\$2723
				

**Resilience**





**How To Order:**

38 - 2472SC4 - SM - CN - K - MBA  
 |           |           |           |           |  
 Series   Model #   Chassis   Top   Edge   Pull

For ordering options, see page 121.

Add 3.75% List Price Increase Effective May 1, 2011

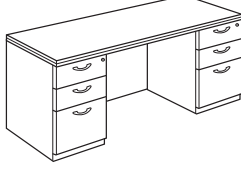
Item	Model No.	Description	Dimensions	List Price
KNEESPACE CREDENZA 	38-2472KC1	<ul style="list-style-type: none"> <li>• Locking Pedestals</li> <li>• Legal Width Pedestals</li> <li>• Box/Box/File in Left Pedestal</li> <li>• File/File in Right Pedestal</li> <li>• Grommet in Back Panel</li> </ul>	Width 72	\$2117
			Depth 24	
KNEESPACE CREDENZA 	38-2472KC2	<ul style="list-style-type: none"> <li>• Locking Pedestals</li> <li>• Legal Width Pedestals</li> <li>• File/File in Left Pedestal</li> <li>• Box/Box/File in Right Pedestal</li> <li>• Grommet in Back Panel</li> </ul>	Depth 24	\$2117
			Height 30	
KNEESPACE CREDENZA 	38-2472KC3	<ul style="list-style-type: none"> <li>• Locking Pedestals</li> <li>• Legal Width Pedestals</li> <li>• File/File in Left Pedestal</li> <li>• File/File in Right Pedestal</li> <li>• Grommet in Back Panel</li> </ul>	Kneespace 36	\$2117
			Ship Wt. 310	
KNEESPACE CREDENZA 	38-2472KC4	<ul style="list-style-type: none"> <li>• Locking Pedestals</li> <li>• Legal Width Pedestals</li> <li>• Box/Box/File in Left Pedestal</li> <li>• Box/Box/File in Right Pedestal</li> <li>• Grommet in Back Panel</li> </ul>	Cubic Ft. 35.6	\$2117
			Width 72	

**How To Order:**

38 - 2472KC4 - SM - CN - K - MBA  
 | | | | |  
 Series Model # Chassis Top Edge Pull

For ordering options, see page 121.



For grommet options, see page 122.

For computer keyboard options, see pages 594-595.

**Resilience**

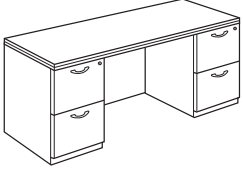
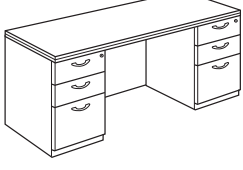

Add 3.75% List Price Increase Effective May 1, 2011

Item	Model No.	Description	Dimensions	List Price
KNEESPACE CREDENZA 	38-2466KC1	<ul style="list-style-type: none"> <li>• Locking Pedestals</li> <li>• Legal Width Pedestals</li> <li>• Box/Box/File in Left Pedestal</li> <li>• File/File in Right Pedestal</li> <li>• Grommet in Back Panel</li> </ul>	Width 66 Depth 24 Height 30 Kneespace 30 Ship Wt. 300 Cubic Ft. 31.46	\$2088
KNEESPACE CREDENZA 	38-2466KC2	<ul style="list-style-type: none"> <li>• Locking Pedestals</li> <li>• Legal Width Pedestals</li> <li>• File/File in Left Pedestal</li> <li>• Box/Box/File in Right Pedestal</li> <li>• Grommet in Back Panel</li> </ul>	Width 66 Depth 24 Height 30 Kneespace 30 Ship Wt. 300 Cubic Ft. 31.46	\$2088
KNEESPACE CREDENZA 	38-2466KC3	<ul style="list-style-type: none"> <li>• Locking Pedestals</li> <li>• Legal Width Pedestals</li> <li>• File/File in Left Pedestal</li> <li>• File/File in Right Pedestal</li> <li>• Grommet in Back Panel</li> </ul>	Width 66 Depth 24 Height 30 Kneespace 30 Ship Wt. 300 Cubic Ft. 31.46	\$2088
KNEESPACE CREDENZA 	38-2466KC4	<ul style="list-style-type: none"> <li>• Locking Pedestals</li> <li>• Legal Width Pedestals</li> <li>• Box/Box/File in Left Pedestal</li> <li>• Box/Box/File in Right Pedestal</li> <li>• Grommet in Back Panel</li> </ul>	Width 66 Depth 24 Height 30 Kneespace 30 Ship Wt. 300 Cubic Ft. 31.46	\$2088

**Resilience**



**How To Order:**

38 - 2466KC4 - SM - CN - K - MBA  
 |           |           |           |           |  
 Series   Model #   Chassis   Top   Edge   Pull

**For ordering options, see page 121.**

**For grommet options, see page 122.**

**For computer keyboard options, see pages 594-595.**

**Add 3.75% List Price Increase Effective May 1, 2011**

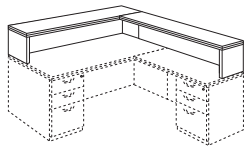
Item	Model No.	Description	Dimensions	List Price
RECEPTION RISER FOR L UNIT RIGHT L WITH 3672 DESK  	38-1472TR	<b>Desk Transaction Riser</b> • For Use on 72" Wide Desks Only	Width 72 Depth 14 Height 12 Ship Wt. 65 Cubic Ft. 10.21	\$ 684
	38-1470RU	<b>Right Return Riser</b> • For Use with 38-1472TR and 38-2448RF	Width 70 Depth 14 Height 12 Ship Wt. 50 Cubic Ft. 10.21	\$ 672

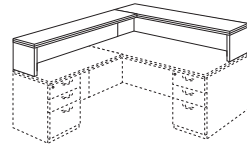
RECEPTION RISER FOR L UNIT LEFT L WITH 3672 DESK  	38-1472TR	<b>Desk Transaction Riser</b> • For Use on 72" Wide Desks Only	Width 72 Depth 14 Height 12 Ship Wt. 65 Cubic Ft. 10.21	\$ 684
	38-1470LU	<b>Left Return Riser</b> • For Use with 38-1472TR and 38-2448LF	Width 70 Depth 14 Height 12 Ship Wt. 50 Cubic Ft. 10.21	\$ 672

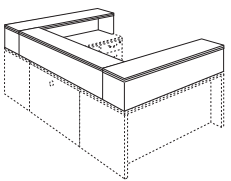
RECEPTION RISER FOR U UNIT WITH 3672 DESK  	38-1472TR	<b>Desk Transaction Riser</b> • For Use on 72" Wide Desks Only	Width 72 Depth 14 Height 12 Ship Wt. 65 Cubic Ft. 10.21	\$ 684
	38-1480BU	<b>Bridge Unit Riser</b> • For Use with Two 38-1472TR's and 38-2448UF	Width 80 Depth 14 Height 12 Ship Wt. 50 Cubic Ft. 4.76	\$ 714
	38-1472TR	<b>Credenza Transaction Riser</b> • For Use on 72" Wide Credenzas Only	Width 72 Depth 14 Height 12 Ship Wt. 65 Cubic Ft. 10.21	\$ 684

**How To Order:**

38 - 1472TR - SM - CN - K  
| | | | |  
Series Model # Chassis Top Edge

For ordering options, see page 121.

**Resilience**

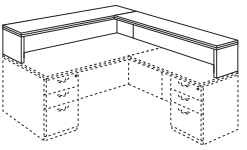

Add 3.75% List Price Increase Effective May 1, 2011

Item	Model No.	Description	Dimensions	List Price
RECEPTION RISER FOR L UNIT RIGHT L WITH 3066 DESK  	38-1466TR	<b>Desk Transaction Riser</b> • For Use on 66" Wide Desks Only	Width 66 Depth 14 Height 12 Ship Wt. 60 Cubic Ft. 9.44	\$ 662
	38-1464RU	<b>Right Return Riser</b> • For Use with 38-1466TR and 38-2448RF	Width 64 Depth 14 Height 12 Ship Wt. 45 Cubic Ft. 9.14	\$ 634

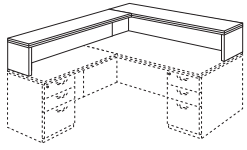
RECEPTION RISER FOR L UNIT LEFT L WITH 3066 DESK  	38-1466TR	<b>Desk Transaction Riser</b> • For Use on 66" Wide Desks Only	Width 66 Depth 14 Height 12 Ship Wt. 60 Cubic Ft. 9.44	\$ 662
	38-1464LU	<b>Left Return Riser</b> • For Use with 38-1466TR and 38-2448LF	Width 64 Depth 14 Height 12 Ship Wt. 45 Cubic Ft. 9.14	\$ 634

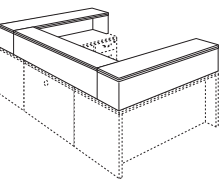
RECEPTION RISER FOR U UNIT WITH 3066 DESK  	38-1466TR	<b>Desk Transaction Riser</b> • For Use on 66" Wide Desks Only	Width 66 Depth 14 Height 12 Ship Wt. 60 Cubic Ft. 9.44	\$ 662
	38-1468BU	<b>Bridge Unit Riser</b> • For Use with Two 38-1466TR's and 38-2442UF	Width 68 Depth 14 Height 12 Ship Wt. 45 Cubic Ft. 4.06	\$ 629
	38-1466TR	<b>Credenza Transaction Riser</b> • For Use on 66" Wide Credenzas Only	Width 66 Depth 14 Height 12 Ship Wt. 60 Cubic Ft. 9.44	\$ 662

**How To Order:**

38 - 1466TR - SM - CN - K  
 | | | | |  
 Series Model # Chassis Top Edge

For ordering options, see page 121.

Add 3.75% List Price Increase Effective May 1, 2011

Resilience

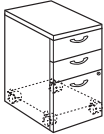
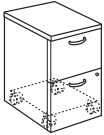
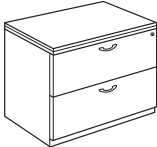
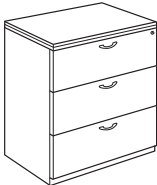
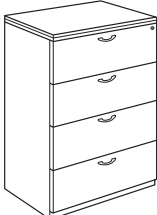

Item	Model No.	Description	Dimensions	List Price
MOBILE PEDESTAL BOX/BOX/FILE 	38-1824MP	<ul style="list-style-type: none"> <li>• Locking Pedestal</li> <li>• Legal Width Pedestal</li> <li>• Box/Box/File in Pedestal</li> <li>• Casters Allow for Easy Moving</li> <li>• Fits Underneath 30" H Worksurfaces</li> </ul>	Width 18 Depth 23 Height 28.5 Ship Wt. 100 Cubic Ft. 8.96	\$ 923
MOBILE PEDESTAL FILE/FILE 	38-1824MP2	<ul style="list-style-type: none"> <li>• Locking Pedestal</li> <li>• Legal Width Pedestal</li> <li>• File/File in Pedestal</li> <li>• Casters Allow for Easy Moving</li> <li>• Fits Underneath 30" H Worksurfaces</li> </ul>	Width 18 Depth 23 Height 28.5 Ship Wt. 100 Cubic Ft. 8.96	\$ 923
LATERAL FILE TWO DRAWERS 	38-2436L2	<ul style="list-style-type: none"> <li>• Locking Drawers</li> <li>• Anti-Tilt system</li> <li>• File Drawers Provide Legal or Letter Filing</li> </ul>	Width 36 Depth 24 Height 30 Ship Wt. 170 Cubic Ft. 17.58	\$1361
LATERAL FILE THREE DRAWERS 	38-2436L3	<ul style="list-style-type: none"> <li>• Locking Drawers</li> <li>• Anti-Tilt system</li> <li>• File Drawers Provide Legal or Letter Filing</li> </ul>	Width 36 Depth 24 Height 42 Ship Wt. 235 Cubic Ft. 24.87	\$1840
LATERAL FILE FOUR DRAWERS 	38-2436L4	<ul style="list-style-type: none"> <li>• Locking Drawers</li> <li>• Anti-Tilt system</li> <li>• File Drawers Provide Legal or Letter Filing</li> </ul>	Width 36 Depth 24 Height 55 Ship Wt. 280 Cubic Ft. 32.45	\$2190

**How To Order:**



38 - 2436L4 - SM - CN - K - MBA  
 | | | | |  
 Series Model # Chassis Top Edge Pull

For ordering options, see page 121.

**Resilience**

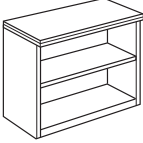

Add 3.75% List Price Increase Effective May 1, 2011

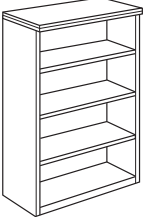
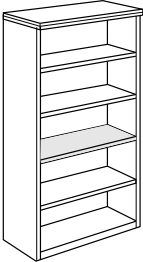
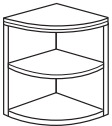
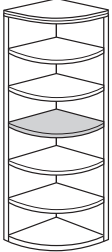
Item	Model No.	Description	Dimensions		List Price
 <p>BOOKCASE</p>	38-3630BC	• One Adjustable Shelf	Width Depth Height Ship Wt. Cubic Ft.	36 14 30 85 11.08	\$ 689
 <p>BOOKCASE</p>	38-3642BC	• Two Adjustable Shelves	Width Depth Height Ship Wt. Cubic Ft.	36 14 42 105 15.31	\$ 768
 <p>BOOKCASE</p>	38-3660BC	• Three Adjustable Shelves	Width Depth Height Ship Wt. Cubic Ft.	36 14 60 149 22.4	\$ 840
 <p>BOOKCASE</p>	38-3672BC	• One Fixed Shelf • Three Adjustable Shelves	Width Depth Height Ship Wt. Cubic Ft.	36 14 72 190 25.69	\$ 976
 <p>¼ ROUND BOOKCASE</p>	38-2430QR	• One Adjustable Shelf	Width Depth Height Ship Wt. Cubic Ft.	24 24 30 95 12.03	\$ 774
 <p>¼ ROUND BOOKCASE</p>	38-1472QR	• One Fixed Shelf • Four Adjustable Shelves	Width Depth Height Ship Wt. Cubic Ft.	14 14 72 130 10.81	\$ 882

**How To Order:**

38 - 1472QR - SM - CN - K  
 |        |        |        |        |  
 Series Model # Chassis Top Edge

For ordering options, see page 121.

**Resilience**

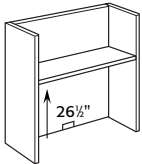

Add 3.75% List Price Increase Effective May 1, 2011

Item	Model No.	Description	Dimensions	List Price
<b>OPEN HUTCH</b> 	38-1436HN	<ul style="list-style-type: none"> <li>• Open Storage</li> <li>• Grommet in Back Panel</li> </ul>	Width 36 Depth 14 Height 40 <sup>13</sup> / <sub>16</sub> Ship Wt. 130 Cubic Ft. 15.31	\$ 408
				TB-3836H    • Optional Tackboard/Specify Seating Fabric Grade 1, 2 or 3    Add:    \$ 334 TL-0824    • Optional Tasklight    Add:    \$ 243

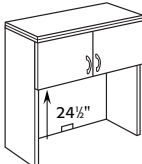
<b>DOOR HUTCH</b> 	38-1436HD	<ul style="list-style-type: none"> <li>• Storage Behind Doors</li> <li>• Two Hinged Doors</li> <li>• Grommet in Back Panel</li> </ul>	Width 36 Depth 14 Height 42 Ship Wt. 135 Cubic Ft. 15.31	\$ 928
				TB-3836H    • Optional Tackboard/Specify Seating Fabric Grade 1, 2 or 3    Add:    \$ 334 TL-0824    • Optional Tasklight    Add:    \$ 243

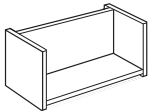
<b>WALL HANG OPEN HUTCH</b> 	38-1436WN	<ul style="list-style-type: none"> <li>• Open Storage</li> <li>• Mounts to Wall</li> <li>• Includes Mounting Rails</li> </ul>	Width 36 Depth 14 Height 12 <sup>13</sup> / <sub>16</sub> Ship Wt. 50 Cubic Ft. 15.31	\$ 360
				TB-0136W    • Optional Wallmount Tackboard/Specify Fabric Grade 1, 2 or 3    Add:    \$ 334

NOTE: Indiana Furniture will not be liable for wall-mounted hutch units that are not properly installed.

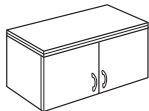
<b>WALL HANG DOOR HUTCH</b> 	38-1436WD	<ul style="list-style-type: none"> <li>• Storage Behind Doors</li> <li>• Two Hinged Doors</li> <li>• Mounts to Wall</li> <li>• Includes Mounting Rails</li> </ul>	Width 36 Depth 14 Height 14 Ship Wt. 60 Cubic Ft. 15.31	\$ 797
				TB-0136W    • Optional Wallmount Tackboard/Specify Fabric Grade 1, 2 or 3    Add:    \$ 334

NOTE: Indiana Furniture will not be liable for wall-mounted hutch units that are not properly installed.

**How To Order:**

38 - 1436WD - SM - CN - K - MBA  
 |        |        |        |        |        |  
 Series Model # Chassis Top Edge Pull

For ordering options, see page 121.

For locking options, see page 122.

For tackboard fabrics, see pages 545-551.

**Resilience**

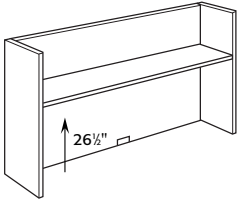

Add 3.75% List Price Increase Effective May 1, 2011

Item	Model No.	Description	Dimensions	List Price
 <p>OPEN HUTCH</p>	38-1472HN	<ul style="list-style-type: none"> <li>Open Storage</li> <li>Grommet in Back Panel</li> </ul>	Width 72 Depth 14 Height 40 <sup>9</sup> / <sub>16</sub> Ship Wt. 180 Cubic Ft. 30.7	\$ 564
	TB-3872H	<ul style="list-style-type: none"> <li>Optional Tackboard/Specify Seating Fabric Grade 1, 2 or 3</li> </ul>		Add: \$ 566
	TL-0848	<ul style="list-style-type: none"> <li>Optional Tasklight</li> </ul>		Add: \$ 338
	38-1466HN	<ul style="list-style-type: none"> <li>Open Storage</li> <li>Grommet in Back Panel</li> </ul>	Width 66 Depth 14 Height 40 <sup>9</sup> / <sub>16</sub> Ship Wt. 165 Cubic Ft. 27.07	\$ 529
	TB-3866H	<ul style="list-style-type: none"> <li>Optional Tackboard/Specify Seating Fabric Grade 1, 2 or 3</li> </ul>		Add: \$ 566
	TL-0848	<ul style="list-style-type: none"> <li>Optional Tasklight</li> </ul>		Add: \$ 338

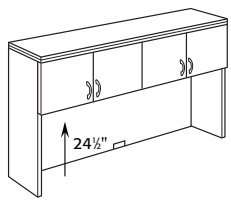
 <p>DOOR HUTCH</p>	38-1472HD	<ul style="list-style-type: none"> <li>Storage Behind Doors</li> <li>Four Hinged Doors</li> <li>Grommet in Back Panel</li> </ul>	Width 72 Depth 14 Height 42 Ship Wt. 207 Cubic Ft. 30.7	\$1432
	TB-3872H	<ul style="list-style-type: none"> <li>Optional Tackboard/Specify Seating Fabric Grade 1, 2 or 3</li> </ul>		Add: \$ 566
	TL-0848	<ul style="list-style-type: none"> <li>Optional Tasklight</li> </ul>		Add: \$ 338
	38-1466HD	<ul style="list-style-type: none"> <li>Storage Behind Doors</li> <li>Four Hinged Doors</li> <li>Grommet in Back Panel</li> </ul>	Width 66 Depth 14 Height 42 Ship Wt. 238 Cubic Ft. 27.07	\$1398
	TB-3866H	<ul style="list-style-type: none"> <li>Optional Tackboard/Specify Seating Fabric Grade 1, 2 or 3</li> </ul>		Add: \$ 566
	TL-0848	<ul style="list-style-type: none"> <li>Optional Tasklight</li> </ul>		Add: \$ 338

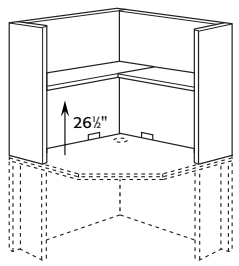
 <p>CORNER UNIT HUTCH</p>	38-4242CH	<ul style="list-style-type: none"> <li>Storage Shelves</li> <li>For Use on Corner Unit Model 38-4242CU and 38-424230CD</li> <li>Grommet in Each Back Panel</li> </ul>	Width 42 Depth 42 Height 40 <sup>9</sup> / <sub>16</sub> Ship Wt. 140 Cubic Ft. 48.18	\$ 725
	TB-3842CH	<ul style="list-style-type: none"> <li>Optional Tackboard/Specify Seating Fabric Grade 1, 2 or 3</li> </ul>		Add: \$ 668
	38-3636CH	<ul style="list-style-type: none"> <li>Storage Shelves</li> <li>For Use on Corner Unit Model 38-3636CU</li> <li>Grommet in Each Back Panel</li> </ul>	Width 36 Depth 36 Height 40 <sup>9</sup> / <sub>16</sub> Ship Wt. 130 Cubic Ft. 35.93	\$ 684
	TB-3836CH	<ul style="list-style-type: none"> <li>Optional Tackboard/Specify Seating Fabric Grade 1, 2 or 3</li> </ul>		Add: \$ 668

**How To Order:**



38 - 1472HD - SM - CN - K - MBA  
 |           |           |           |           |           |  
 Series   Model #   Chassis   Top   Edge   Pull

For ordering options, see page 121.

For locking options, see page 122.

For tackboard fabrics, see pages 545-551.

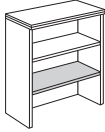
Add 3.75% List Price Increase Effective May 1, 2011

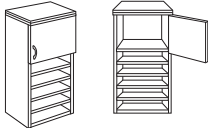
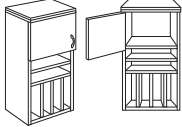
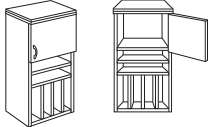
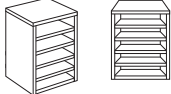
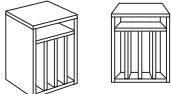
Item	Model No.	Description	Dimensions	List Price
TOP UNIT BOOKCASE 	38-1436TU	<ul style="list-style-type: none"> <li>Bottom Shelf Fixed</li> <li>One Adjustable Shelf</li> </ul>	Width 36 Depth 14 Height 42 Ship Wt. 125 Cubic Ft. 15.31	\$ 708
STORAGE TOWER LEFT HINGED DOOR 	38-1418HL1	<ul style="list-style-type: none"> <li>Left Hinged Door</li> <li>Storage Behind Door</li> <li>Adjustable Shelves</li> </ul>	Width 18 Depth 14 Height 42 Ship Wt. 80 Cubic Ft. 8.06	\$ 708
STORAGE TOWER RIGHT HINGED DOOR 	38-1418HR1	<ul style="list-style-type: none"> <li>Right Hinged Door</li> <li>Storage Behind Door</li> <li>Adjustable Shelves</li> </ul>	Width 18 Depth 14 Height 42 Ship Wt. 80 Cubic Ft. 8.06	\$ 708
STORAGE TOWER LEFT HINGED DOOR 	38-1418HL2	<ul style="list-style-type: none"> <li>Left Hinged Door</li> <li>Storage Behind Door</li> <li>Horizontal and Vertical Storage</li> </ul>	Width 18 Depth 14 Height 42 Ship Wt. 80 Cubic Ft. 8.06	\$ 732
STORAGE TOWER RIGHT HINGED DOOR 	38-1418HR2	<ul style="list-style-type: none"> <li>Right Hinged Door</li> <li>Storage Behind Door</li> <li>Horizontal and Vertical Storage</li> </ul>	Width 18 Depth 14 Height 42 Ship Wt. 80 Cubic Ft. 8.06	\$ 732
PORTABLE TOWER UNIT 	38-1418HH	<ul style="list-style-type: none"> <li>Adjustable Shelves</li> </ul>	Width 18 Depth 12½ Height 22 Ship Wt. 45 Cubic Ft. 4.35	\$ 443
PORTABLE TOWER UNIT 	38-1418HV	<ul style="list-style-type: none"> <li>Horizontal and Vertical Storage</li> </ul>	Width 18 Depth 12½ Height 22 Ship Wt. 45 Cubic Ft. 4.35	\$ 433

**How To Order:**

38 - 1418HR1 - SM - CN - K - MBA  
 |        |        |        |        |        |  
 Series Model # Chassis Top Edge Pull

For ordering options, see page 121.

**Resilience**



Add 3.75% List Price Increase Effective May 1, 2011

Item	Model No.	Description	Dimensions	List Price
STORAGE CABINET	38-1872STL	<ul style="list-style-type: none"> <li>• Left Hinged Door</li> <li>• Top - Door with Two Adjustable Shelves Behind Door</li> <li>• Bottom - Box/Box/File</li> <li>• Locking on Drawers</li> </ul>	Width 18 Depth 24 Height 72 Ship Wt. 160 Cubic Ft. 22.12	\$1637

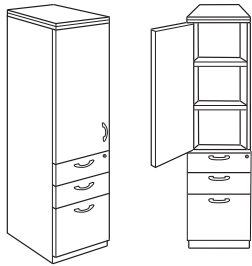

STORAGE CABINET	38-1872STR	<ul style="list-style-type: none"> <li>• Right Hinged Door</li> <li>• Top - Door with Two Adjustable Shelves Behind Door</li> <li>• Bottom - Box/Box/File</li> <li>• Locking on Drawers</li> </ul>	Width 18 Depth 24 Height 72 Ship Wt. 160 Cubic Ft. 22.12	\$1938
-----------------	------------	--	--	--------

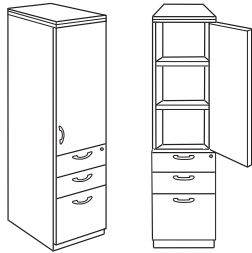

STORAGE UNIT	38-3672SU1	<ul style="list-style-type: none"> <li>• Top - Two Doors with Two Adjustable Shelves Behind Doors</li> <li>• Bottom - File/File</li> <li>• Locking on Drawers</li> <li>• File Drawers Provide Legal or Letter Filing</li> </ul>	Width 36 Depth 24 Height 72 Ship Wt. 300 Cubic Ft. 42.02	\$1938
--------------	------------	---	--	--------

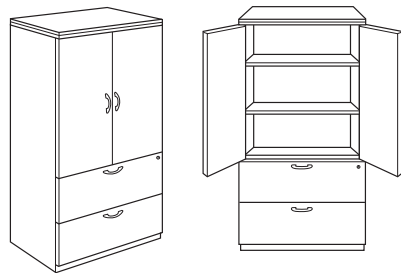



**How To Order:**

38 - 3672SU1 - SM - CN - K - MBA  
 | | | | | |  
 Series Model # Chassis Top Edge Pull

For ordering options, see page 121.

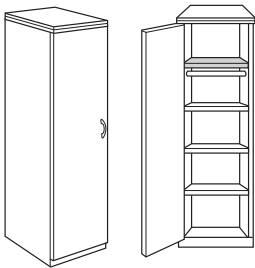
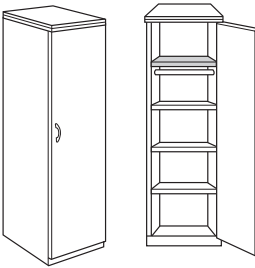
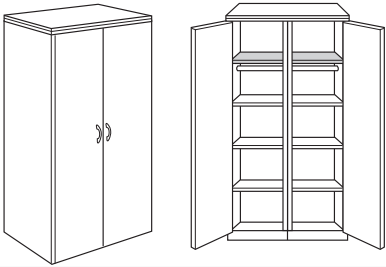
Add 3.75% List Price Increase Effective May 1, 2011

Item	Model No.	Description	Dimensions	List Price
 <p>WARDROBE/STORAGE CABINET</p>	38-1872WL	<ul style="list-style-type: none"> <li>Hinged Left</li> <li>Top Shelf Fixed</li> <li>Coat Rod Under Fixed Shelf</li> <li>Three Adjustable Shelves</li> <li>Adjustable Shelves can be Removed for Wardrobe Application</li> </ul>	Width 18 Depth 24 Height 72 Ship Wt. 160 Cubic Ft. 22.12	\$1231
 <p>WARDROBE/STORAGE CABINET</p>	38-1872WR	<ul style="list-style-type: none"> <li>Hinged Right</li> <li>Top Shelf Fixed</li> <li>Coat Rod Under Fixed Shelf</li> <li>Three Adjustable Shelves</li> <li>Adjustable Shelves can be Removed for Wardrobe Application</li> </ul>	Width 18 Depth 24 Height 72 Ship Wt. 160 Cubic Ft. 22.12	\$1231
 <p>WARDROBE/STORAGE CABINET</p>	38-3672WC	<ul style="list-style-type: none"> <li>Two Doors</li> <li>Top Shelf Fixed Behind Each Door</li> <li>Coat Rod Under Each Fixed Shelf</li> <li>Three Adjustable Shelves Behind Each Door</li> <li>Adjustable Shelves can be Removed for Wardrobe Application</li> </ul>	Width 36 Depth 24 Height 72 Ship Wt. 320 Cubic Ft. 42.02	\$2093
 <p>WARDROBE/STORAGE CABINET</p>	38-3672WC1	<ul style="list-style-type: none"> <li>Right Side - Top Shelf Fixed, Coat Rod, and Three Adjustable Shelves</li> <li>Left Side - Top Storage with Two Adjustable Shelves, Bottom Locking Box/Box/File</li> </ul>	Width 36 Depth 24 Height 72 Ship Wt. 320 Cubic Ft. 42.02	\$2153
 <p>WARDROBE/STORAGE CABINET</p>	38-3672WC2	<ul style="list-style-type: none"> <li>Left Side - Top Shelf Fixed, Coat Rod, and Three Adjustable Shelves</li> <li>Right Side - Top Storage with Two Adjustable Shelves, Bottom Locking Box/Box/File</li> </ul>	Width 36 Depth 24 Height 72 Ship Wt. 320 Cubic Ft. 42.02	\$2153

**How To Order:**

38 - 3672WC1 - SM - CN - K - MBA  
 |           |           |           |           |  
 Series   Model #   Chassis   Top   Edge   Pull

For ordering options, see page 121.

**Resilience**

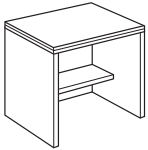
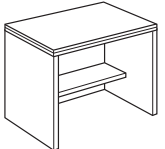
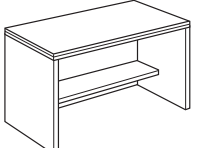
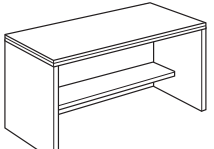

Add 3.75% List Price Increase Effective May 1, 2011

Item	Model No.	Description	Dimensions	List Price
COMPUTER WORK TABLE 	38-2430CW	<ul style="list-style-type: none"> <li>Fixed Shelf</li> <li>Grommet in Back Panel</li> </ul>	Width 30 Depth 24 Height 30 Ship Wt. 105 Cubic Ft. 14.81	\$ 702
COMPUTER WORK TABLE 	38-2436CW	<ul style="list-style-type: none"> <li>Fixed Shelf</li> <li>Grommet in Back Panel</li> </ul>	Width 36 Depth 24 Height 30 Ship Wt. 115 Cubic Ft. 17.58	\$ 732
COMPUTER WORK TABLE 	38-2448CW	<ul style="list-style-type: none"> <li>Fixed Shelf</li> <li>Grommet in Back Panel</li> </ul>	Width 48 Depth 24 Height 30 Ship Wt. 125 Cubic Ft. 23.13	\$ 862
COMPUTER WORK TABLE 	38-2454CW	<ul style="list-style-type: none"> <li>Fixed Shelf</li> <li>Grommet in Back Panel</li> </ul>	Width 54 Depth 24 Height 30 Ship Wt. 135 Cubic Ft. 25.91	\$ 928

**Resilience**



**How To Order:**

38 - 2448CW - SM - CN - K  
 |        |        |        |        |  
 Series Model # Chassis Top Edge

For ordering options, see page 121.  
 For computer keyboard options, see pages 594-595.

Add 3.75% List Price Increase Effective May 1, 2011

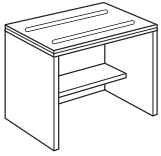
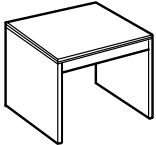
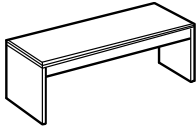
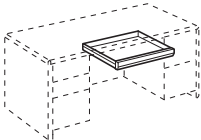
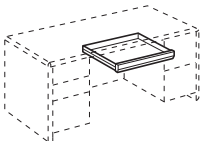
Item	Model No.	Description	Dimensions	List Price
PRINTER TABLE 	38-2436PT	<ul style="list-style-type: none"> <li>Fixed Shelf for Paper Feed or Paper Catch</li> <li>Accommodates Various Size Printers</li> <li>Two Paper Slots</li> </ul>	Width 36 Depth 24 Height 30 Ship Wt. 125 Cubic Ft. 17.58	\$ 840
LAMP TABLE 	38-2430LT	<ul style="list-style-type: none"> <li>Lamp Table</li> <li>Shipped KD</li> </ul>	Width 30 Depth 24 Height 22 Ship Wt. 75 Cubic Ft. 2.53	\$ 667
MAGAZINE TABLE 	38-2448MT	<ul style="list-style-type: none"> <li>Magazine Table</li> <li>Shipped KD</li> </ul>	Width 48 Depth 24 Height 16 Ship Wt. 85 Cubic Ft. 3.95	\$ 780
OPTIONAL CENTER DRAWER 	38-2122CD	<ul style="list-style-type: none"> <li>Center Drawer</li> </ul>	Width 22 Depth 21 Height 2¾ Ship Wt. 9 Cubic Ft. 1.74	\$132 Factory Installed Add: \$110
OPTIONAL CENTER DRAWER 	38-1622CD	<ul style="list-style-type: none"> <li>Center Drawer</li> <li>For use on 36" D Top and 42" P Top Units with Modesty Panels</li> </ul>	Width 22 Depth 16 Height 2¾ Ship Wt. 7 Cubic Ft. 1.3	\$120 Factory Installed Add: \$110

**How To Order:**

38 - 2430LT - SM - CN - K  
 | | | | |  
 Series Model # Chassis Top Edge

For ordering options, see page 121.

**Resilience**



Add 3.75% List Price Increase Effective May 1, 2011

Item	Model No.	Description	Dimensions	List Price
36" CIRCULAR TOP	38-3636CT	<ul style="list-style-type: none"> <li>• 36" Diameter</li> <li>• 1<sup>3</sup>/<sub>16</sub>" Thick Top</li> <li>• Single Base Required</li> <li>• Accommodates Three Chairs</li> </ul>	Width 36 Depth 36 Height 1 <sup>3</sup> / <sub>16</sub> Ship Wt. 37 Cubic Ft. 3.13	\$ 667

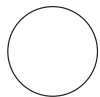

42" CIRCULAR TOP	38-4242CT	<ul style="list-style-type: none"> <li>• 42" Diameter</li> <li>• 1<sup>3</sup>/<sub>16</sub>" Thick Top</li> <li>• Single Base Required</li> <li>• Accommodates Four Chairs</li> </ul>	Width 42 Depth 42 Height 1 <sup>3</sup> / <sub>16</sub> Ship Wt. 70 Cubic Ft. 4.20	\$ 876
------------------	-----------	--	--	--------

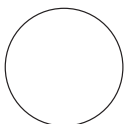

48" CIRCULAR TOP	38-4848CT	<ul style="list-style-type: none"> <li>• 48" Diameter</li> <li>• 1<sup>3</sup>/<sub>16</sub>" Thick Top</li> <li>• Single Base Required</li> <li>• Accommodates Five Chairs</li> </ul>	Width 48 Depth 48 Height 1 <sup>3</sup> / <sub>16</sub> Ship Wt. 95 Cubic Ft. 5.43	\$ 918
------------------	-----------	--	--	--------

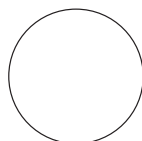

**How To Order:**

38 - 4242CT - CN - K  
 |           |           |           |  
 Series   Model #   Top       Edge

For ordering options, see page 121.

Bases must be ordered separately.

See page 155 for base options.

Add 3.75% List Price Increase Effective May 1, 2011

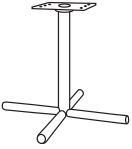
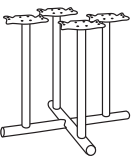
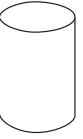
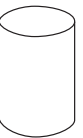
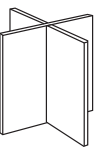
Item	Model No.	Description	Dimensions	List Price
METAL BASE 	38-0400MB	<ul style="list-style-type: none"> <li>Black Metal Base</li> <li>See Top Size for Number of Bases Required</li> <li>Shipped KD</li> </ul>	Width 32 Depth 32 Height 27¾ Ship Wt. 26 Cubic Ft. 3	\$ 508
NOTE: Some assembly required.				
METAL CRISS - CROSS BASE 	38-0404MB	<ul style="list-style-type: none"> <li>Black Metal Base</li> <li>See Top Size for Number of Bases Required</li> <li>Shipped KD</li> </ul>	Width 36 Depth 36 Height 27¾ Ship Wt. 35 Cubic Ft. 3	\$ 756
NOTE: Some assembly required.				
CYLINDER 	38-1616CB	<ul style="list-style-type: none"> <li>Laminate Cylinder Base</li> <li>Weighted for Stability</li> <li>See Top Size for Number of Bases Required</li> <li>For Use on 36" Round Table</li> </ul>	Width 16 Depth 16 Height 28½ Ship Wt. 101 Cubic Ft. 10.4	\$ 682
CYLINDER 	38-2020CB	<ul style="list-style-type: none"> <li>Laminate Cylinder Base</li> <li>Weighted for Stability</li> <li>See Top Size for Number of Bases Required</li> <li>For Use on 42" &amp; 48" Round Tables</li> </ul>	Width 20 Depth 20 Height 28½ Ship Wt. 136 Cubic Ft. 10.4	\$ 741
X BASE 	38-2424XB	<ul style="list-style-type: none"> <li>Laminate X Base</li> <li>See Top Size for Number of Bases Required</li> <li>Shipped KD</li> </ul>	Width 24 Depth 24 Height 28½ Ship Wt. 70 Cubic Ft. 2.39	\$ 497
NOTE: Some assembly required.				

**How To Order:**

38 - 2020CB - YC  
 |        |        |  
 Series Model # Chassis

For ordering options, see page 121.

**Resilience**  
 GREENGUARD  
 Add 3.75% List Price Increase Effective May 1, 2011

Item	Model No.	Description	Dimensions	List Price
VIDEO CABINET	38-3672VC	<ul style="list-style-type: none"> <li>• Top Section VCR Shelf</li> <li>• Bottom Section Box/Box/File with Letter or Legal Filing Capabilities</li> <li>• Holds up to 27" TV</li> <li>• 170° Hinge on Doors</li> <li>• Grommet in Back Panel</li> <li>• Locking Drawers</li> </ul>	Width 36 Depth 24 Height 72 Ship Wt. 300 Cubic Ft. 42.02	\$2039
		<ul style="list-style-type: none"> <li>• 1-2516TV</li> <li>• Optional Factory Installed Slide Out and Swivel T.V. Tray</li> </ul>		Add: \$ 364

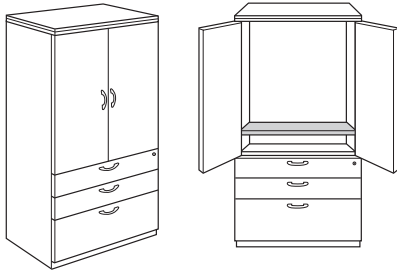

VIDEO CABINET	38-3672VC1	<ul style="list-style-type: none"> <li>• Top Section VCR Shelf</li> <li>• Bottom Section File/File with Letter or Legal Filing Capabilities</li> <li>• Holds up to 27" TV</li> <li>• 170° Hinge on Doors</li> <li>• Grommet in Back Panel</li> <li>• Locking Drawers</li> </ul>	Width 36 Depth 24 Height 72 Ship Wt. 300 Cubic Ft. 42.02	\$2045
		<ul style="list-style-type: none"> <li>• 1-2516TV</li> <li>• Optional Factory Installed Slide Out and Swivel T.V. Tray</li> </ul>		Add: \$ 364

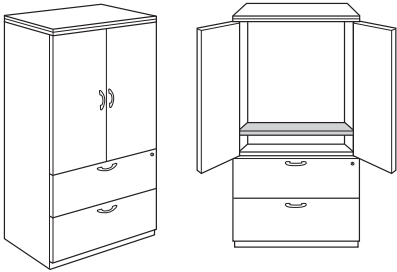

VISUAL BOARD	38-4848VB	<ul style="list-style-type: none"> <li>• Visual Board</li> <li>• Milestone Ebony Fabric Tackboard on Each Door</li> <li>• Display Rail with Adjustable Hooks for Flipchart</li> <li>• Flipchart</li> <li>• Magnetic Porcelain Non-Glare Writing Surface</li> <li>• Set of Four Dry Markers and Eraser</li> </ul>	Width 48 Depth 5 Height 48 Ship Wt. 150 Cubic Ft. 10.95	\$1248
		<ul style="list-style-type: none"> <li>• 1-PS</li> <li>• Optional Factory Installed Projection Screen</li> </ul>		Add: \$575

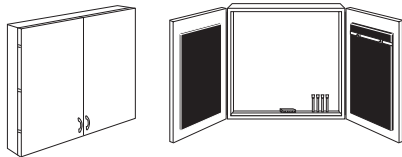

NOTE: Visual Boards are shipped with appropriate rails for mounting.  
 NOTE: Visual Boards available only in squared edge and chassis colors.  
 NOTE: Indiana Furniture will not be liable for visual boards that are not properly installed.

**How To Order:**

38 - 4848VB - SM - MBW  
 |        |        |        |  
 Series Model # Chassis - Pull

For ordering options, see page 121.

Add 3.75% List Price Increase Effective May 1, 2011

Item	Model No.	Description	Dimensions		List Price
Bow Top WORKSURFACE 	38-4272BWT	<ul style="list-style-type: none"> <li>• Bow Top</li> <li>• Shaped Four Sides</li> </ul>	Width	72	\$1223
			Depth	42-36	
			Height	1 <sup>3</sup> / <sub>16</sub>	
			Ship Wt.	125	
			Cubic Ft.	7.13	

Bow Top WORKSURFACE 	38-3672BWT	<ul style="list-style-type: none"> <li>• Bow Top</li> <li>• Shaped Four Sides</li> </ul>	Width	72	\$1223
			Depth	36-30	
			Height	1 <sup>3</sup> / <sub>16</sub>	
			Ship Wt.	110	
			Cubic Ft.	6.16	

DESK WORKSURFACE 72"W x 36"D 	38-3672TP	<ul style="list-style-type: none"> <li>• Desk Top</li> <li>• Shaped Four Sides</li> </ul>	Width	72	\$ 827
			Depth	36	
			Height	1 <sup>3</sup> / <sub>16</sub>	
			Ship Wt.	115	
			Cubic Ft.	6.16	

**How To Order:**

38 - 4272BWT - CN - K  
 |           |           |           |  
 Series   Model #   Top   Edge

For ordering options, see page 121.

For grommet options, see page 122.

# RESILIENCE 3800 SERIES

## Modular Components

Item	Model No.	Description	Dimensions		List Price	
WORKSURFACE 30" DEEP 	38-3042TP	<ul style="list-style-type: none"> <li>Shaped Four Sides</li> <li>For Use on 30" Deep Pedestals</li> </ul>	Width	42	\$ 594	
			Depth	30		
			Height	1 <sup>3</sup> / <sub>16</sub>		
			Ship Wt.	55		
			Cubic Ft.	2.69		
	38-3048TP	<ul style="list-style-type: none"> <li>Shaped Four Sides</li> <li>For Use on 30" Deep Pedestals</li> </ul>	Width	48		\$ 600
			Depth	30		
			Height	1 <sup>3</sup> / <sub>16</sub>		
			Ship Wt.	60		
		Cubic Ft.	3.06			
38-3054TP	<ul style="list-style-type: none"> <li>Shaped Four Sides</li> <li>For Use on 30" Deep Pedestals</li> </ul>	Width	54	\$ 677		
		Depth	30			
		Height	1 <sup>3</sup> / <sub>16</sub>			
		Ship Wt.	70			
		Cubic Ft.	3.43			
38-3060TP	<ul style="list-style-type: none"> <li>Shaped Four Sides</li> <li>For Use on 30" Deep Pedestals</li> </ul>	Width	60		\$ 719	
		Depth	30			
		Height	1 <sup>3</sup> / <sub>16</sub>			
		Ship Wt.	75			
		Cubic Ft.	3.8			
38-3066TP	<ul style="list-style-type: none"> <li>Shaped Four Sides</li> <li>For Use on 30" Deep Pedestals</li> </ul>	Width	66	\$ 780		
		Depth	30			
		Height	1 <sup>3</sup> / <sub>16</sub>			
		Ship Wt.	80			
		Cubic Ft.	4.17			
38-3072TP	<ul style="list-style-type: none"> <li>Shaped Four Sides</li> <li>For Use on 30" Deep Pedestals</li> </ul>	Width	72		\$ 810	
		Depth	30			
		Height	1 <sup>3</sup> / <sub>16</sub>			
		Ship Wt.	85			
		Cubic Ft.	4.57			
38-3078TP	<ul style="list-style-type: none"> <li>Shaped Four Sides</li> <li>For Use on 30" Deep Pedestals</li> </ul>	Width	78	\$ 882		
		Depth	30			
		Height	1 <sup>3</sup> / <sub>16</sub>			
		Ship Wt.	90			
		Cubic Ft.	4.93			
38-3084TP	<ul style="list-style-type: none"> <li>Shaped Four Sides</li> <li>For Use on 30" Deep Pedestals</li> </ul>	Width	84		\$ 918	
		Depth	30			
		Height	1 <sup>3</sup> / <sub>16</sub>			
		Ship Wt.	95			
		Cubic Ft.	5.3			

NOTE: When 30" deep modular tops have a kneespace of 60" or more, a support T panel is needed to support the top. See page 170 for model #38-1010SP.

### How To Order:

38 - 3042TP - CN - K  
 | | | |  
 Series Model # Top Edge

For ordering options, see page 121.

For grommet options, see page 122.

Add 3.75% List Price Increase Effective May 1, 2011

Item	Model No.	Description	Dimensions	List Price
<b>WORKSURFACE</b> <b>24" DEEP</b> 	38-2418TP	<ul style="list-style-type: none"> <li>Shaped Four Sides</li> <li>For Use on 24" Deep Pedestals/Files</li> </ul>	Width 18 Depth 24 Height 1 <sup>3</sup> / <sub>16</sub> Ship Wt. 28 Cubic Ft. 1.03	\$ 319
	38-2430TP	<ul style="list-style-type: none"> <li>Shaped Four Sides</li> <li>For Use on 24" Deep Pedestals/Files</li> </ul>	Width 30 Depth 24 Height 1 <sup>3</sup> / <sub>16</sub> Ship Wt. 36 Cubic Ft. 1.61	\$ 378
	38-2436TP	<ul style="list-style-type: none"> <li>Shaped Four Sides</li> <li>For Use on 24" Deep Pedestals/Files</li> </ul>	Width 36 Depth 24 Height 1 <sup>3</sup> / <sub>16</sub> Ship Wt. 45 Cubic Ft. 1.91	\$ 401
	38-2442TP	<ul style="list-style-type: none"> <li>Shaped Four Sides</li> <li>For Use on 24" Deep Pedestals/Files</li> </ul>	Width 42 Depth 24 Height 1 <sup>3</sup> / <sub>16</sub> Ship Wt. 50 Cubic Ft. 2.21	\$ 438
	38-2448TP	<ul style="list-style-type: none"> <li>Shaped Four Sides</li> <li>For Use on 24" Deep Pedestals/Files</li> </ul>	Width 48 Depth 24 Height 1 <sup>3</sup> / <sub>16</sub> Ship Wt. 55 Cubic Ft. 2.52	\$ 473
	38-2454TP	<ul style="list-style-type: none"> <li>Shaped Four Sides</li> <li>For Use on 24" Deep Pedestals/Files</li> </ul>	Width 54 Depth 24 Height 1 <sup>3</sup> / <sub>16</sub> Ship Wt. 65 Cubic Ft. 2.82	\$ 534
	38-2460TP	<ul style="list-style-type: none"> <li>Shaped Four Sides</li> <li>For Use on 24" Deep Pedestals/Files</li> </ul>	Width 60 Depth 24 Height 1 <sup>3</sup> / <sub>16</sub> Ship Wt. 70 Cubic Ft. 3.12	\$ 539
	38-2466TP	<ul style="list-style-type: none"> <li>Shaped Four Sides</li> <li>For Use on 24" Deep Pedestals/Files</li> </ul>	Width 66 Depth 24 Height 1 <sup>3</sup> / <sub>16</sub> Ship Wt. 75 Cubic Ft. 3.43	\$ 618
	38-2472TP	<ul style="list-style-type: none"> <li>Shaped Four Sides</li> <li>For Use on 24" Deep Pedestals/Files</li> </ul>	Width 72 Depth 24 Height 1 <sup>3</sup> / <sub>16</sub> Ship Wt. 80 Cubic Ft. 3.74	\$ 641
	38-2478TP	<ul style="list-style-type: none"> <li>Shaped Four Sides</li> <li>For Use on 24" Deep Pedestals/Files</li> </ul>	Width 78 Depth 24 Height 1 <sup>3</sup> / <sub>16</sub> Ship Wt. 85 Cubic Ft. 4.01	\$ 697
	38-2484TP	<ul style="list-style-type: none"> <li>Shaped Four Sides</li> <li>For Use on 24" Deep Pedestals/Files</li> </ul>	Width 84 Depth 24 Height 1 <sup>3</sup> / <sub>16</sub> Ship Wt. 90 Cubic Ft. 4.33	\$ 737
	38-2490TP	<ul style="list-style-type: none"> <li>Shaped Four Sides</li> <li>For Use on 24" Deep Pedestals/Files</li> </ul>	Width 90 Depth 24 Height 1 <sup>3</sup> / <sub>16</sub> Ship Wt. 95 Cubic Ft. 4.62	\$ 768
	38-2496TP	<ul style="list-style-type: none"> <li>Shaped Four Sides</li> <li>For Use on 24" Deep Pedestals/Files</li> </ul>	Width 96 Depth 24 Height 1 <sup>3</sup> / <sub>16</sub> Ship Wt. 100 Cubic Ft. 4.93	\$ 792
	38-24102TP	<ul style="list-style-type: none"> <li>Shaped Four Sides</li> <li>For Use on 24" Deep Pedestals/Files</li> </ul>	Width 102 Depth 24 Height 1 <sup>3</sup> / <sub>16</sub> Ship Wt. 105 Cubic Ft. 5.22	\$ 816
	38-24108TP	<ul style="list-style-type: none"> <li>Shaped Four Sides</li> <li>For Use on 24" Deep Pedestals/Files</li> </ul>	Width 108 Depth 24 Height 1 <sup>3</sup> / <sub>16</sub> Ship Wt. 110 Cubic Ft. 5.53	\$ 918

NOTE: When 24" deep modular tops have a kneespace of 60" or more, a support T panel is needed to support the top. See page 170 for model #38-1010SP.

**How To Order:**

38 - 2418TP - CN - K  
 |        |        |        |  
 Series Model # Top Edge

For ordering options, see page 121.

For grommet options, see page 122.

**Resilience**  
  
 Add 3.75% List Price Increase Effective May 1, 2011

# RESILIENCE 3800 SERIES

## Modular Components

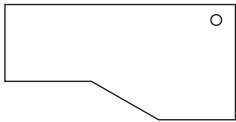
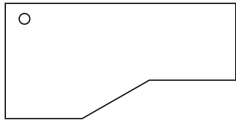
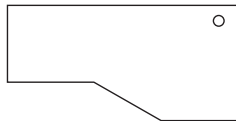
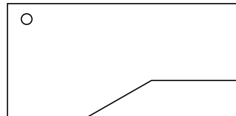



Item	Model No.	Description	Dimensions	List Price
EXTENDED CORNER ANGLED TOP 	38-3672ETL	<ul style="list-style-type: none"> <li>Extended Corner Top Worksurface</li> <li>Grommet in top</li> <li>Shaped on all sides</li> </ul>	Width 72 Depth 36-24 Height 1 <sup>3</sup> / <sub>16</sub> Ship Wt. 95 Cubic Ft. 6.16	\$ 816
EXTENDED CORNER ANGLED TOP 	38-3672ETR	<ul style="list-style-type: none"> <li>Extended Corner Top Worksurface</li> <li>Grommet in top</li> <li>Shaped on all sides</li> </ul>	Width 72 Depth 36-24 Height 1 <sup>3</sup> / <sub>16</sub> Ship Wt. 95 Cubic Ft. 6.16	\$ 816
EXTENDED CORNER ANGLED TOP 	38-3066ETL	<ul style="list-style-type: none"> <li>Extended Corner Top Worksurface</li> <li>Grommet in top</li> <li>Shaped on all sides</li> </ul>	Width 66 Depth 30-24 Height 1 <sup>3</sup> / <sub>16</sub> Ship Wt. 60 Cubic Ft. 4.08	\$ 786
EXTENDED CORNER ANGLED TOP 	38-3066ETR	<ul style="list-style-type: none"> <li>Extended Corner Top Worksurface</li> <li>Grommet in top</li> <li>Shaped on all sides</li> </ul>	Width 66 Depth 30-24 Height 1 <sup>3</sup> / <sub>16</sub> Ship Wt. 60 Cubic Ft. 4.08	\$ 786

### How To Order:

38 - 3672ETL - CN - K  
 | | | |  
 Series Model # Top Edge

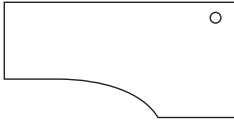
For ordering options, see page 121.

Add 3.75% List Price Increase Effective May 1, 2011

Item	Model No.	Description	Dimensions		List Price
EXTENDED CORNER COCKPIT TOP 	38-3672ETL1	<ul style="list-style-type: none"> <li>Extended Corner Top Worksurface</li> <li>Grommet in top</li> <li>Shaped on all sides</li> </ul>	Width	72	\$ 816
			Depth	36-24	
			Height	1 <sup>3</sup> / <sub>16</sub>	
			Ship Wt.	95	
			Cubic Ft.	6.16	
EXTENDED CORNER COCKPIT TOP 	38-3672ETR1	<ul style="list-style-type: none"> <li>Extended Corner Top Worksurface</li> <li>Grommet in top</li> <li>Shaped on all sides</li> </ul>	Width	72	\$ 816
			Depth	36-24	
			Height	1 <sup>3</sup> / <sub>16</sub>	
			Ship Wt.	95	
			Cubic Ft.	6.16	
EXTENDED CORNER COCKPIT TOP 	38-3066ETL1	<ul style="list-style-type: none"> <li>Extended Corner Top Worksurface</li> <li>Grommet in top</li> <li>Shaped on all sides</li> </ul>	Width	66	\$ 786
			Depth	30-24	
			Height	1 <sup>3</sup> / <sub>16</sub>	
			Ship Wt.	60	
			Cubic Ft.	4.08	
EXTENDED CORNER COCKPIT TOP 	38-3066ETR1	<ul style="list-style-type: none"> <li>Extended Corner Top Worksurface</li> <li>Grommet in top</li> <li>Shaped on all sides</li> </ul>	Width	66	\$ 786
			Depth	30-24	
			Height	1 <sup>3</sup> / <sub>16</sub>	
			Ship Wt.	60	
			Cubic Ft.	4.08	

**How To Order:**

38 - 3672ETL1 - CN - K  
 |           |           |           |  
 Series   Model #   Top       Edge

For ordering options, see page 121.

**Resilience**  
  
 Add 3.75% List Price Increase Effective May 1, 2011

# RESILIENCE 3800 SERIES

## Modular Components

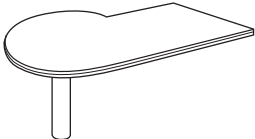
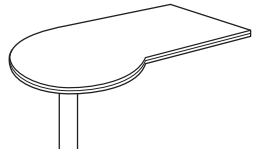
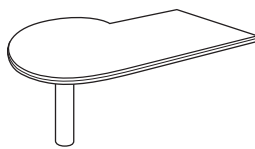
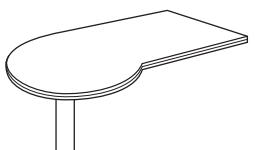
Item	Model No.	Description	Dimensions	List Price
LEFT P-TOP WITH CYLINDER BASE 	38-4272TL	<ul style="list-style-type: none"> <li>Black Metal</li> <li>Base - 4" Diameter</li> <li>Shipped KD</li> </ul>	Width 72 Depth 42-36 Height 30 Ship Wt. 120 Cubic Ft. 7.13	\$1320
RIGHT P-TOP WITH CYLINDER BASE 	38-4272TR	<ul style="list-style-type: none"> <li>Black Metal</li> <li>Base - 4" Diameter</li> <li>Shipped KD</li> </ul>	Width 72 Depth 42-36 Height 30 Ship Wt. 120 Cubic Ft. 7.13	\$1320
LEFT P-TOP WITH CYLINDER BASE 	38-3672TL	<ul style="list-style-type: none"> <li>Black Metal</li> <li>Base - 4" Diameter</li> <li>Shipped KD</li> </ul>	Width 72 Depth 36-30 Height 30 Ship Wt. 115 Cubic Ft. 6.16	\$1205
RIGHT P-TOP WITH CYLINDER BASE 	38-3672TR	<ul style="list-style-type: none"> <li>Black Metal</li> <li>Base - 4" Diameter</li> <li>Shipped KD</li> </ul>	Width 72 Depth 36-30 Height 30 Ship Wt. 115 Cubic Ft. 6.16	\$1205

Resilience



### How To Order:

38 - 4272TL - CN - K  
 |           |           |           |  
 Series   Model #   Top       Edge

For ordering options, see page 121.  
 For grommet options, see page 122.

Add 3.75% List Price Increase Effective May 1, 2011

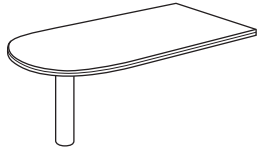
Item	Model No.	Description	Dimensions	List Price
D-Top WITH CYLINDER BASE 	38-3672DR	<ul style="list-style-type: none"> <li>• Black Metal</li> <li>• Base - 4" Diameter</li> <li>• Shipped KD</li> </ul>	Width 72 Depth 36 Height 30 Ship Wt. 115 Cubic Ft. 6.16	\$1115

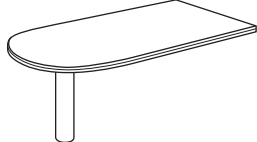
D-Top WITH CYLINDER BASE 	38-3072DR	<ul style="list-style-type: none"> <li>• Black Metal</li> <li>• Base - 4" Diameter</li> <li>• Shipped KD</li> </ul>	Width 72 Depth 30 Height 30 Ship Wt. 110 Cubic Ft. 4.57	\$1038
--	-----------	---	---	--------

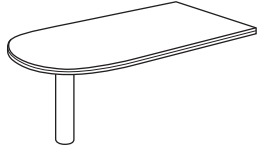
D-Top WITH CYLINDER BASE 	38-3066DR	<ul style="list-style-type: none"> <li>• Black Metal</li> <li>• Base - 4" Diameter</li> <li>• Shipped KD</li> </ul>	Width 66 Depth 30 Height 30 Ship Wt. 105 Cubic Ft. 4.17	\$ 918
--	-----------	---	---	--------

**How To Order:**

38 - 3672DR - CN - K  
 | | | |  
 Series Model # Top Edge

For ordering options, see page 121.

For grommet options, see page 122.

**Resilience**



Add 3.75% List Price Increase Effective May 1, 2011

# RESILIENCE 3800 SERIES

## Modular Components

Item	Model No.	Description	Dimensions		List Price
DESK PEDESTAL Box/Box/File	38-3618PD1	<ul style="list-style-type: none"> <li>• Desk Pedestal</li> <li>• Box/Box/File</li> <li>• Locking</li> <li>• Finished Back</li> </ul>	Width	18	\$1008
			Depth	36	
			Height	28 <sup>13</sup> / <sub>16</sub>	
			Ship Wt.	139	
			Cubic Ft.	13.08	

DESK PEDESTAL FILE/FILE	38-3618PD2	<ul style="list-style-type: none"> <li>• Desk Pedestal</li> <li>• File/File</li> <li>• Locking</li> <li>• Finished Back</li> </ul>	Width	18	\$1008
			Depth	36	
			Height	28 <sup>13</sup> / <sub>16</sub>	
			Ship Wt.	139	
			Cubic Ft.	13.08	

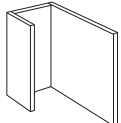
DESK PEDESTAL SHELL	38-3618PD3	<ul style="list-style-type: none"> <li>• Desk Pedestal Shell</li> <li>• Used to Complete Single Pedestal Desk Configuration</li> <li>• Can be Used as Left Pedestal Shell or Right Pedestal Shell</li> <li>• Finished Back</li> </ul>	Width	18	\$ 395
			Depth	36	
			Height	28 <sup>13</sup> / <sub>16</sub>	
			Ship Wt.	45	
			Cubic Ft.	13.08	



### How To Order:

38 - 3618PD2 - SM - MBA  
 |           |           |           |  
 Series   Model #   Top       Edge

For ordering options, see page 121.

Component worksurface must be specified separately, see page 157.

Add 3.75% List Price Increase Effective May 1, 2011

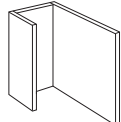
Item	Model No.	Description	Dimensions	List Price
DESK PEDESTAL Box/Box/FILE 	38-3018PD1	<ul style="list-style-type: none"> <li>• Desk Pedestal</li> <li>• Box/Box/File</li> <li>• Locking</li> <li>• Finished Back</li> </ul>	Width 18 Depth 30 Height 28 <sup>13</sup> / <sub>16</sub> Ship Wt. 116 Cubic Ft. 11.06	\$ 997
DESK PEDESTAL FILE/FILE 	38-3018PD2	<ul style="list-style-type: none"> <li>• Desk Pedestal</li> <li>• File/File</li> <li>• Locking</li> <li>• Finished Back</li> </ul>	Width 18 Depth 30 Height 28 <sup>13</sup> / <sub>16</sub> Ship Wt. 116 Cubic Ft. 11.06	\$ 997
DESK PEDESTAL SHELL 	38-3018PD3	<ul style="list-style-type: none"> <li>• Desk Pedestal Shell</li> <li>• Used to Complete Single Pedestal Desk Configuration</li> <li>• Can be Used as Left Pedestal Shell or Right Pedestal Shell</li> <li>• Finished Back</li> </ul>	Width 18 Depth 30 Height 28 <sup>13</sup> / <sub>16</sub> Ship Wt. 42 Cubic Ft. 11.06	\$ 353

**How To Order:**

38 - 3018PD2 - SM - MBA  
 |           |           |           |  
 Series   Model #   Chassis   Pull

For ordering options, see page 121.  
 Component worksurface must be specified separately, see page 158.



**Resilience**



Add 3.75% List Price Increase Effective May 1, 2011

# RESILIENCE 3800 SERIES

## Modular Components

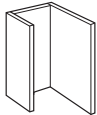
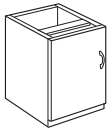
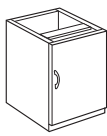
Item	Model No.	Description	Dimensions		List Price
CREDENZA, RETURN PEDESTAL BOX/BOX/FILE 	38-2418PD1	<ul style="list-style-type: none"> <li>Credenza, Return Pedestal</li> <li>Box/Box/File</li> <li>Locking</li> <li>Finished Back</li> </ul>	Width	18	\$ 869
			Depth	24	
			Height	28 <sup>13</sup> / <sub>16</sub>	
			Ship Wt.	93	
			Cubic Ft.	9.6	
CREDENZA, RETURN PEDESTAL FILE/FILE 	38-2418PD2	<ul style="list-style-type: none"> <li>Credenza, Return Pedestal</li> <li>File/File</li> <li>Locking</li> <li>Finished Back</li> </ul>	Width	18	\$ 869
			Depth	24	
			Height	28 <sup>13</sup> / <sub>16</sub>	
			Ship Wt.	93	
			Cubic Ft.	9.6	
CREDENZA PEDESTAL SHELL 	38-2418PD3	<ul style="list-style-type: none"> <li>Credenza Pedestal Shell</li> <li>Used to Complete Single Pedestal Credenza Configuration</li> <li>Can be Used as Left Pedestal Shell or Right Pedestal Shell</li> <li>Finished Back</li> </ul>	Width	18	\$ 300
			Depth	24	
			Height	28 <sup>13</sup> / <sub>16</sub>	
			Ship Wt.	40	
			Cubic Ft.	9.6	
CREDENZA/RETURN PEDESTAL DOOR BOOKCASE 	38-2418PD4L	<ul style="list-style-type: none"> <li>Credenza/Return Pedestal</li> <li>Door Bookcase</li> <li>Hinged Left</li> <li>Adjustable Shelf</li> </ul>	Width	18	\$ 575
			Depth	24	
			Height	28 <sup>13</sup> / <sub>16</sub>	
			Ship Wt.	70	
			Cubic Ft.	9.6	
CREDENZA/RETURN PEDESTAL DOOR BOOKCASE 	38-2418PD4R	<ul style="list-style-type: none"> <li>Credenza/Return Pedestal</li> <li>Door Bookcase</li> <li>Hinged Right</li> <li>Adjustable Shelf</li> </ul>	Width	18	\$ 575
			Depth	24	
			Height	28 <sup>13</sup> / <sub>16</sub>	
			Ship Wt.	70	
			Cubic Ft.	9.6	

### How To Order:

38 - 2418PD2 - SM - MBA  
 |            |            |            |  
 Series    Model #    Chassis   Pull

For ordering options, see page 121.

Component worksurface must be specified separately, see page 159.

Add 3.75% List Price Increase Effective May 1, 2011

Item	Model No.	Description	Dimensions		List Price
------	-----------	-------------	------------	--	------------

LATERAL FILE	38-2436LF1	<ul style="list-style-type: none"> <li>• File/File</li> <li>• Locking</li> <li>• Anti-Tilt System</li> <li>• Finished Back</li> </ul>	Width	36	\$1062
--------------	------------	---	-------	----	--------

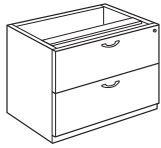

Depth	24
Height	28 <sup>13</sup> / <sub>16</sub>
Ship Wt.	154
Cubic Ft.	18.5

LATERAL FILE	38-2436LF2	<ul style="list-style-type: none"> <li>• Upper - Box/Box/File</li> <li>• Lower - File</li> <li>• Locking File Drawers Only</li> <li>• Finished Back</li> </ul>	Width	36	\$1108
--------------	------------	--	-------	----	--------

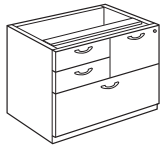

Depth	24
Height	28 <sup>13</sup> / <sub>16</sub>
Ship Wt.	154
Cubic Ft.	18.5

LATERAL FILE	38-2436LF4	<ul style="list-style-type: none"> <li>• Upper - File/File</li> <li>• Lower - File</li> <li>• Locking</li> <li>• Finished Back</li> </ul>	Width	36	\$1108
--------------	------------	---	-------	----	--------



Depth	24
Height	28 <sup>13</sup> / <sub>16</sub>
Ship Wt.	154
Cubic Ft.	18.5

**How To Order:**

38 - 2436LF2 - SM - MBA  
 |           |           |           |  
 Series   Model #   Chassis   Pull

For ordering options, see page 121.

Component worksurface must be specified separately, see page 159.

**Resilience**



Add 3.75% List Price Increase Effective May 1, 2011

# RESILIENCE 3800 SERIES

## Modular Components

Item	Model No.	Description	Dimensions	List Price
OPEN BOOKCASE	38-2436BC	<ul style="list-style-type: none"> <li>• Open Bookcase</li> <li>• Adjustable Shelf</li> <li>• Shelf 12<math>\frac{1}{8}</math> deep</li> <li>• Finished Back</li> </ul>	Width 36 Depth 24 Height 28 $\frac{3}{16}$ Ship Wt. 95 Cubic Ft. 18.5	\$ 575

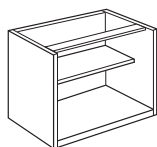

DOOR BOOKCASE	38-2436DB	<ul style="list-style-type: none"> <li>• Door Bookcase</li> <li>• Adjustable Shelf</li> <li>• Shelf 12<math>\frac{1}{8}</math> deep</li> <li>• Finished Back</li> </ul>	Width 36 Depth 24 Height 28 $\frac{3}{16}$ Ship Wt. 105 Cubic Ft. 18.5	\$ 719
---------------	-----------	---	--	--------

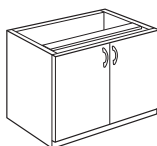

THREE DRAWER FILE	38-2436TF	<ul style="list-style-type: none"> <li>• Three File Drawers</li> <li>• Locking</li> <li>• Anti-Tilt System</li> <li>• Finished Back</li> </ul>	Width 36 Depth 24 Height 40 $\frac{3}{16}$ Ship Wt. 180 Cubic Ft. 24.3	\$1667
-------------------	-----------	--	--	--------



FOUR DRAWER FILE	38-2436QF	<ul style="list-style-type: none"> <li>• Four File Drawers</li> <li>• Locking</li> <li>• Anti-Tilt System</li> <li>• Finished Back</li> </ul>	Width 36 Depth 24 Height 53 $\frac{3}{16}$ Ship Wt. 205 Cubic Ft. 31.59	\$1889
------------------	-----------	---	---	--------



### How To Order:

38 - 2436BC - SM - MBA  
 |        |        |        |  
 Series Model # Chassis Pull

For ordering options, see page 121.

Component worksurface must be specified separately, see page 159.

Add 3.75% List Price Increase Effective May 1, 2011

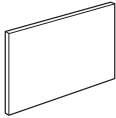
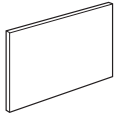
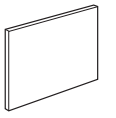
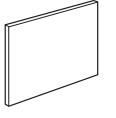
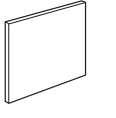
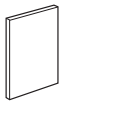
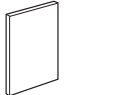
Item	Model No.	Description	Dimensions	List Price
MODESTY PANEL 	38-5428BP	• Shipped with Attachment Hardware	Width 54 Depth ¾ Height 28 <sup>13</sup> / <sub>16</sub> Ship Wt. 65 Cubic Ft. 3.74	\$ 306
MODESTY PANEL 	38-4828BP	• Shipped with Attachment Hardware	Width 48 Depth ¾ Height 28 <sup>13</sup> / <sub>16</sub> Ship Wt. 55 Cubic Ft. 3.34	\$ 294
MODESTY PANEL 	38-4228BP	• Shipped with Attachment Hardware	Width 42 Depth ¾ Height 28 <sup>13</sup> / <sub>16</sub> Ship Wt. 50 Cubic Ft. 2.91	\$ 282
MODESTY PANEL 	38-3628BP	• Shipped with Attachment Hardware	Width 36 Depth ¾ Height 28 <sup>13</sup> / <sub>16</sub> Ship Wt. 45 Cubic Ft. 2.55	\$ 263
MODESTY PANEL 	38-3028BP	• Shipped with Attachment Hardware	Width 30 Depth ¾ Height 28 <sup>13</sup> / <sub>16</sub> Ship Wt. 30 Cubic Ft. 2.12	\$ 252
MODESTY PANEL 	38-2428BP	• Shipped with Attachment Hardware	Width 24 Depth ¾ Height 28 <sup>13</sup> / <sub>16</sub> Ship Wt. 18 Cubic Ft. 1.72	\$ 228
MODESTY PANEL 	38-1828BP	• Shipped with Attachment Hardware	Width 18 Depth ¾ Height 28 <sup>13</sup> / <sub>16</sub> Ship Wt. 12 Cubic Ft. 1.36	\$ 199

NOTE: Modesty panels are used in conjunction with component worksurfaces and component pedestals and files to create a fully enclosed kneespace in desk, bridge, return or credenza applications.

**How To Order:**

38 - 3028BP - SM  
 |        |        |  
 Series Model # Chassis

For ordering options, see page 121.

**Resilience**  
**GREENGUARD**  
 Add 3.75% List Price Increase Effective May 1, 2011

# RESILIENCE 3800 SERIES

## Modular Components

Item	Model No.	Description	Dimensions		List Price
SUPPORT "T"	38-1010SP	• Support "T"	Width	10	\$ 175
			Depth	10	
			Height	28 <sup>13</sup> / <sub>16</sub>	
			Ship Wt.	20	
			Cubic Ft.	0.74	

NOTE: Support "T" is required for added support in the center of long worksurfaces where pedestals or files are not used for support. Required for use when kneespace area is 60" or more.

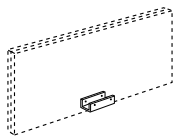
GANGING BRACKET	38-0104GB	<ul style="list-style-type: none"> <li>Ganging Bracket</li> <li>Attaches Pedestals and Files without Defacing Visible Areas of Units</li> </ul>	Width	4	\$ 30
			Depth	1½	
			Height	1¼	
			Ship Wt.	1	

NOTE: Optional ganging brackets can be used to attach two or more pedestals or files in side by side configuration. Use of ganging bracket will prevent defacing of finished end panels and allow for future re-configurability.

### How To Order:

38 - 1010SP - SM  
 |            |            |  
 Series    Model #    Chassis

For ordering options, see page 121.

Item	Model No.	Description	Dimensions	List Price
EXECUTIVE RIGHT "L"	38-1	<ul style="list-style-type: none"> <li>Executive Right L</li> </ul>	Width 72 Depth 84 Height 30 Ship Wt. 420 Cubic Ft. 75.9	\$3214
	<u>Qty</u>	<u>Consists of:</u>		
	1	38-3672LP1	<ul style="list-style-type: none"> <li>Left Pedestal Desk</li> </ul>	\$1877
	1	38-2448RF1	<ul style="list-style-type: none"> <li>Executive Right Return</li> </ul>	<del>\$1337</del>
				TOTAL \$3214

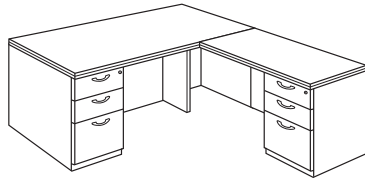

EXECUTIVE RIGHT "U" P-Top	38-3	<ul style="list-style-type: none"> <li>Executive Right U with P-Top</li> </ul>	Width 72 Depth 114 Height 30 Ship Wt. 491 Cubic Ft. 97.43	\$3838
	<u>Qty</u>	<u>Consists of:</u>		
	1	38-4272PL	<ul style="list-style-type: none"> <li>P-Top with End Support, Cylinder Base and Modesty Panel</li> </ul>	\$1553
	1	38-2448UF	<ul style="list-style-type: none"> <li>Executive Bridge Unit</li> </ul>	\$ 689
	1	38-2472RC1	<ul style="list-style-type: none"> <li>Right Pedestal Credenza</li> </ul>	<del>\$1596</del>
				TOTAL \$3838

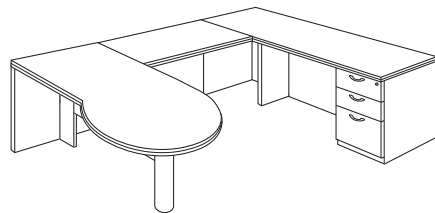

**How To Order:**

38 - 3 - SM - CN - K - MBA  
 | | | | | |  
 Series Model # Chassis Top Edge Pull

For ordering options, see page 121.

For standard options, see page 122.

**Resilience**



Add 3.75% List Price Increase Effective May 1, 2011

# RESILIENCE 3800 SERIES

## Sample Arrangements

Item	Model No.	Description	Dimensions		List Price
RECEPTION WORKSTATION	38-6	• Reception Workstation	Width	72	\$8600
			Depth	84	
			Height	42	
			Ship Wt.	1175	
			Cubic Ft.	150.91	

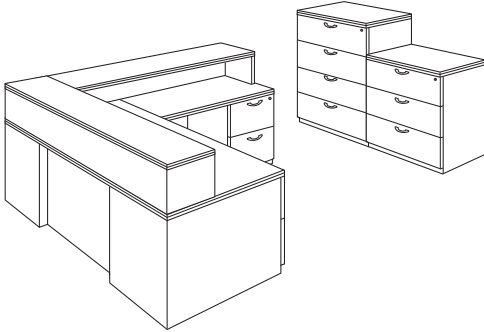

Qty	Consists of:		
1	38-3672LP1	• Left Ped Desk	\$1877
1	38-2448RF2	• Right Return	\$1337
1	38-1472TR	• Transaction Riser	\$ 684
1	38-1470RU	• Transaction Riser for Return	\$ 672
1	38-2436L4	• Four Drawer Lateral File	\$2190
1	38-2436L3	• Three Drawer Lateral File	\$1840
		<b>TOTAL</b>	<b>\$8600</b>

EXECUTIVE WORKSTATION	38-7	• Executive Workstation	Width	72	\$6527
			Depth	114	
			Height	72	
			Ship Wt.	930	
			Cubic Ft.	124.13	

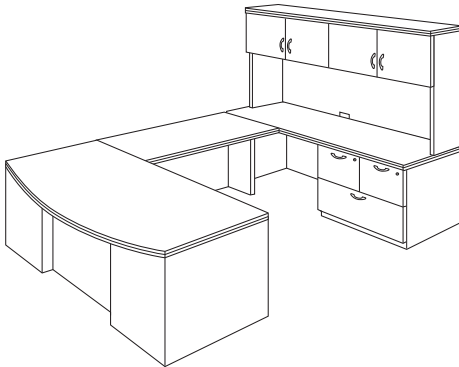

Qty	Consists of:		
1	38-4272LP1	• Bow Top Left Ped Desk	\$2158
1	38-2448UF	• Bridge Unit	\$ 689
1	38-2472TP	• Component Top	\$ 641
1	38-2436LF4	• Component Lateral File	\$1108
1	38-2418PD3	• Pedestal Shell	\$ 300
1	38-1828BP	• Modesty Panel	\$ 199
1	38-1472HD	• Door Hutch	\$1432
		<b>TOTAL</b>	<b>\$6527</b>

### How To Order:

38 - 6 - SM - CN - K - MBA  
 | | | | |  
 Series Model # Chassis Top Edge Pull

For ordering options, see page 121.

For standard options, see page 122.

Add 3.75% List Price Increase Effective May 1, 2011

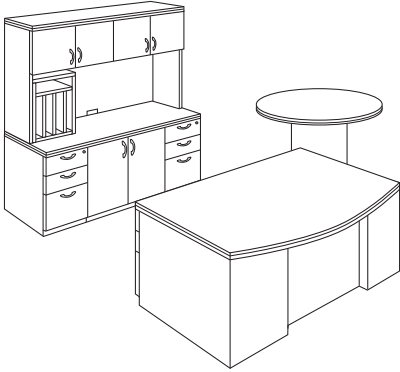
Item	Model No.	Description	Dimensions	List Price
EXECUTIVE OFFICE	38-8	• Executive Office	Width 72 Depth 114 Height 72 Ship Wt. 1215 Cubic Ft. 142.17	\$8801
				
	<b>Qty</b>	<b>Consists of:</b>		
	1	38-4272DP4	• Double Ped/Bow Front Desk	\$2554
	1	38-2472SC4	• Storage Credenza	\$2723
	1	38-1472HD	• Door Hutch	\$1432
	1	38-1418HV	• Portable Tower Unit	\$ 433
	1	38-4848CT	• Circular Table Top	\$ 918
	1	38-2020CB	• Cylinder Base	\$ 741
				<b>TOTAL \$8801</b>

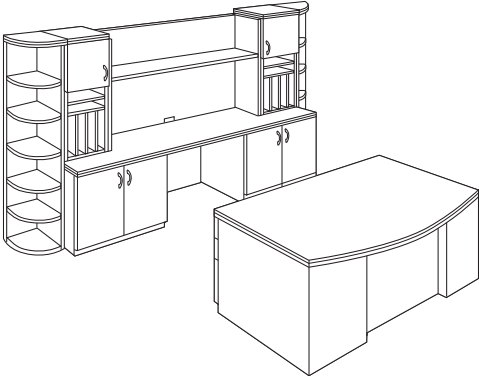
EXECUTIVE OFFICE	38-9	• Executive Office	Width 144 Depth 114 Height 72 Ship Wt. 1215 Cubic Ft. 166.05	\$8965
				
	<b>Qty</b>	<b>Consists of:</b>		
	1	38-4272DP1	• Double Ped/Bow Front Desk	\$2554
	2	38-2436DB	• Component Door Bookcase	\$1438
	1	38-24108TP	• Component Top	\$ 918
	1	38-1418HL2	• Tower Unit	\$ 732
	1	38-1418HR2	• Tower Unit	\$ 732
	1	38-1472HN	• Open Hutch	\$ 564
	2	38-1472QR	• Quarter Round Bookcase	\$1764
	1	38-3628BP	• Back Panel	\$ 263
				<b>TOTAL \$8965</b>

**How To Order:**

38 - 8 - SM - CN - K - MBA  
 | | | | |  
 Series Model # Chassis Top Edge Pull

For ordering options, see page 121.  
 For standard options, see page 122.

**Resilience**  
  
 Add 3.75% List Price Increase Effective May 1, 2011

# RESILIENCE 3800 SERIES

## Sample Arrangements

Item	Model No.	Description	Dimensions	List Price
------	-----------	-------------	------------	------------

EXECUTIVE "U" WORKSTATION

38-10

• Executive "U" Workstation

Width 90  
Depth 102  
Height 72  
Ship Wt. 900  
Cubic Ft. 146.51

\$7130

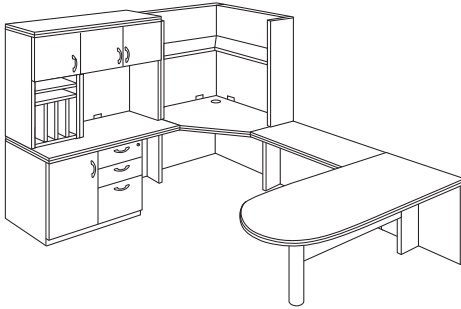

Qty	Consists of:		
1	38-3060DU	• D Top with End Panel, Cylinder Base and Modesty Panel	\$ 1115
1	38-2436UF	• Bridge Unit	\$ 594
1	38-3636CU	• Corner Unit	\$ 900
1	38-2418PD1	• Component Pedestal	\$ 869
1	38-2418PD4L	• Component Pedestal	\$ 575
1	38-2454TP	• Component Top	\$ 534
1	38-3636CH	• Corner Hutch	\$ 684
1	38-1436HD	• Door Hutch	\$ 928
1	38-1418HL2	• Tower Unit	\$ 732
1	38-1828BP	• Back Panel	\$ 199
			<b>TOTAL \$7130</b>

EXECUTIVE "U" WORKSTATION

38-11

• Executive "U" Workstation

Width 108  
Depth 114  
Height 72  
Ship Wt. 1183  
Cubic Ft. 188.59

\$8870

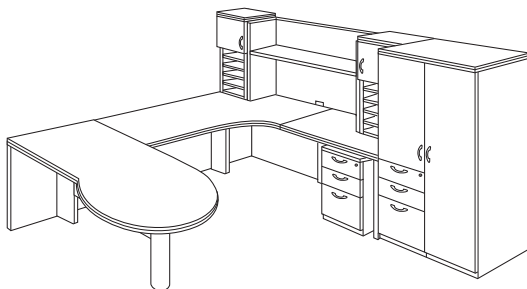

Qty	Consists of:		
1	38-4272PL	• Left P Unit with End Panel, Cylinder Base and Modesty Panel	\$1553
1	38-3672ETL1	• Extended Corner Cockpit Top	\$ 816
1	38-3618PD3	• Pedestal Shell	\$ 395
1	38-5428BP	• Back Panel	\$ 306
1	38-2436TP	• Component Top	\$ 401
1	38-2418PD3	• Pedestal Shell	\$ 300
1	38-1828BP	• Modesty Panel	\$ 199
1	38-1418HL1	• Storage Tower	\$ 708
1	38-1436HN	• Open Hutch	\$ 408
1	38-1418HR1	• Storage Tower	\$ 708
1	38-3672WC1	• Wardrobe/Storage Cabinet	\$2153
1	38-1824MP	• Mobile Pedestal	\$ 923
			<b>TOTAL \$8870</b>

### How To Order:

38 - 10 - SM - CN - K - MBA  
Series Model # Chassis Top Edge Pull

For ordering options, see page 121.

For standard options, see page 122.

Add 3.75% List Price Increase Effective May 1, 2011

Item	Model No.	Description	Dimensions	List Price
------	-----------	-------------	------------	------------

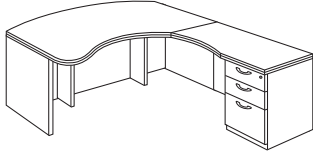
EXECUTIVE RIGHT "L" COCKPIT SHELL Bow Top  	38-13	EXECUTIVE RIGHT "L" COCKPIT SHELL Bow Top	Width	78	\$3276
			Depth	84	
			Height	30	
			Ship Wt.	470	
			Cubic Ft.	83	

<u>Qty</u>	<u>Consists of:</u>		
1	38-4278CLSH	• Executive Left Cockpit Shell	\$1866
1	38-2442CRF1	• Cockpit Right Return	\$1410
		<b>TOTAL</b>	<b>\$3276</b>

NOTE: Tops are non reconfigurable.

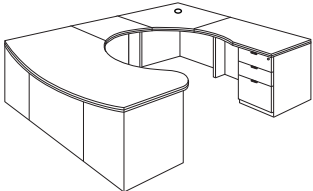
EXECUTIVE COCKPIT SHELL RIGHT "U"  	38-17	EXECUTIVE COCKPIT SHELL RIGHT "U"	Width	78	\$4773
			Depth	98	
			Height	30	
			Ship Wt.	665	
			Cubic Ft.	111	

<u>Qty</u>	<u>Consists of:</u>		
1	38-4278CLSH	• Executive Left Cockpit Shell	\$1866
1	38-2420CUF	• Cockpit Bridge	\$ 539
1	38-3636CCU	• Cockpit Corner Unit	\$ 958
1	38-2442CRF1	• Cockpit Right Return	\$1410
		<b>TOTAL</b>	<b>\$4773</b>

NOTE: Tops are non reconfigurable.

**How To Order:**

38 - 17 - SM - CN - K - MBA  
| | | | |  
Series Model # Chassis Top Edge Pull

For ordering options, see page 121.

For standard options, see page 122.

**Resilience**



Add 3.75% List Price Increase Effective May 1, 2011

## **HOW PEDESTALS AND FILES ARE ATTACHED TO TOPS**

Pedestals and files are attached to tops by metal to metal fasteners. This is for the future reconfigurability of units. The diagram shows how tops are fastened with metal inserts into each top. Metal inserts are placed in all possible locations of the top for any pedestal or file configuration. Post and Cam systems are also used for the attachment of tops to pedestals and files.

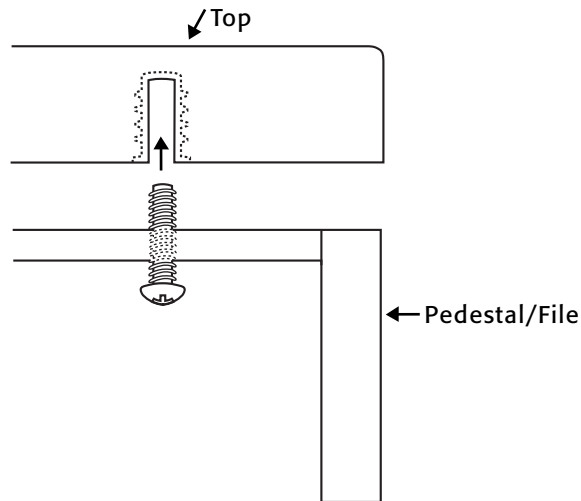

## **HOW DESK MODESTY PANELS ARE ATTACHED TO PEDESTALS**

Desk modesty panels are attached to pedestals by metal brackets. The diagram shows the bracket connecting the modesty panel to the inside of the pedestal in the kneespace. When ordering assembled units, these brackets are already used to assemble the unit. When specifying component modesty panels, two brackets will ship with each modesty panel for field assembly.

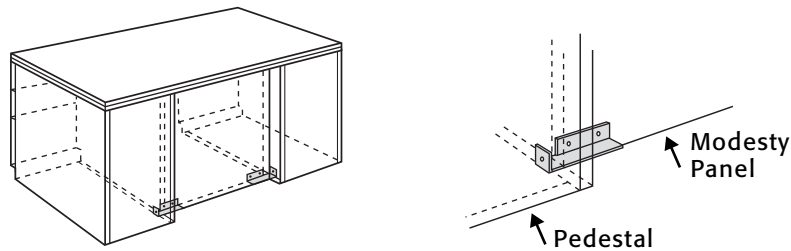

## **HOW CREDENZA/RETURN MODESTY PANELS ARE ATTACHED**

Credenza/Return modesty panels are attached to pedestals and files by metal brackets. The diagram shows the bracket connecting the modesty panel to the inside of the pedestal or file in the kneespace. When ordering assembled units, these brackets are already used to assemble the unit. When specifying component modesty panels, two brackets will ship with each modesty panel for field assembly.

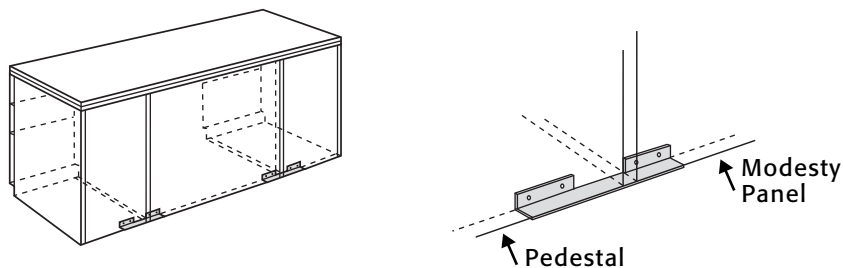

**This page left blank  
for new product introductions.**

**Resilience**



**Add 3.75% List Price Increase Effective May 1, 2011**